

JACOMEX

pure safety

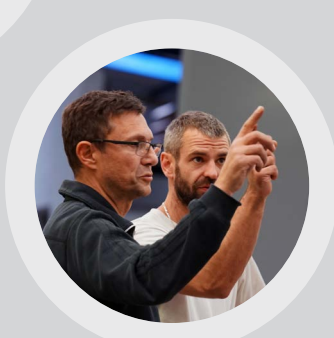

GLOVE BOXES EXPERT

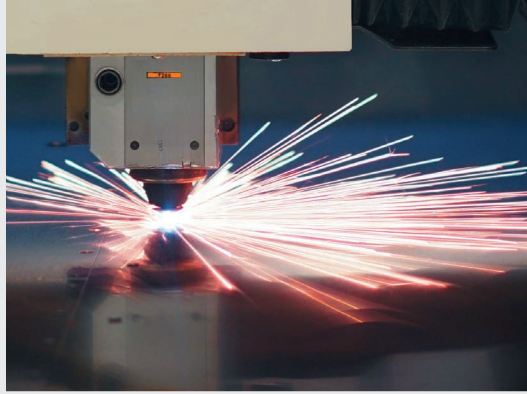

SPECIAL THANKS

We would like to thank our customers for their trust and loyalty. The dynamic and intelligent relationship we maintain with them is particularly inspiring. Sharing ideas boost our performance towards enhanced quality and reliability.



















Let us not forget our employees, agents and sales representatives. Our success rests on their skills, reliability and investment which are an essential part of our corporate culture.

Last but not least, we would like to thank our long-term suppliers for their participation and the important technical support they provide for standard and custom installations.

JACOMEX is a member company of the group



Table of contents

THE COMPANY		4
GLOVE BOXES		6
THE RANGE AT A GLIMPSE		8
PURESMART	  	10
PUREMOD	  	12
PUREEVO	   	14
G BOX	 	16
G MEGA		17
G SAFE	  	18
G ISO		20
G POLYM	 	21
DIMENSIONS OF THE GLOVE BOXES FROM THE PURE RANGE		22
COMPARATIVE DATA - PURE RANGE		24
GAS PURIFICATION UNITS		25
PROJECTS		29
REFERENCES		38

MARKETS - APPLICATIONS



RESEARCH

Organic and Organometallic Chemistry. Catalysis. Electrochemistry. Physics. Materials, Polymer and Surface Science. Molecular Biology, Metalloproteins. Biochemistry, Geoscience, Anaerobia...



INDUSTRY

Aeronautics, Titanium and superalloys welding. Additive Manufacturing and Powders. Chemistry, Enhanced Oil Recovery and Petrochemistry. Defense and Microelectronics. Studies and processes on air sensitive materials. Food industry...



ENERGY

Lithium Batteries, Graphene, Supercapacitors, Fuel cells, Hydrogen storage, TFD techniques, Organic and Flexible Electronics, OPVs and Perovskite solar cells, OLEDs, OTFTs, OLAE, EPDs, 2D materials, Quantum Dots, Biosensors, OFETs, MOSFETs, Semiconductors, Nanotechnologies...



PHARMA - MEDICAL

Operators and products protection Filtration, drying, scaling, toxic or hygroscopic powder repacking. Chemical synthesis and handling of APIs, CMR, cytotoxic, microorganisms and pathogens samples. Clean environments ISO5 14644-1...



NUCLEAR

Radioprotection, R&D on nuclear combustibles. Waste sorting and disposal. Corrosion study, new materials, R&D on future reactors, sodium and MOX. Nuclear materials analysis lines...

LEADER IN **DESIGN AND MANUFACTURING OF**
 INERT GAS PURIFICATION UNITS, GLOVE BOXES / ISOLATORS
 CONTAINMENT ENCLOSURES OF ALL DIMENSIONS



JACOMEX manages your project from targeting your needs to delivering the installation.

Combining human commercial and technical supports with modern fabrication tools is the key to provide the necessary expertise and flexibility to design perfectly fitted modular and custom installations.

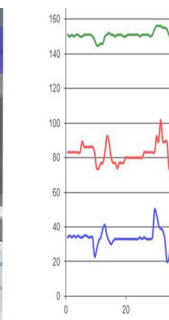
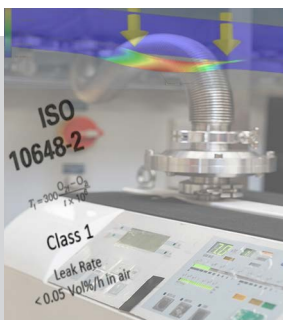

75 **YEARS**
 Experience,
 Know-How,
 Development

Turnover **ABROAD** 50%

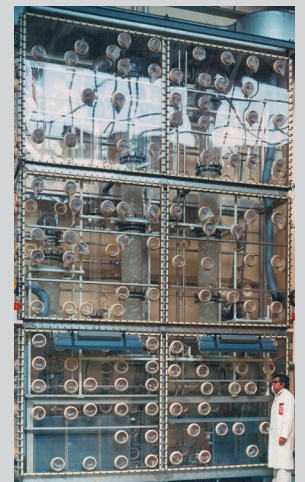

1940

1960

1980

AN INTERNATIONAL CONSULTING SERVICE

Experienced men with a close and responsive presence.
(Design office, Methods office, Manufacturing, Assembly, tests)

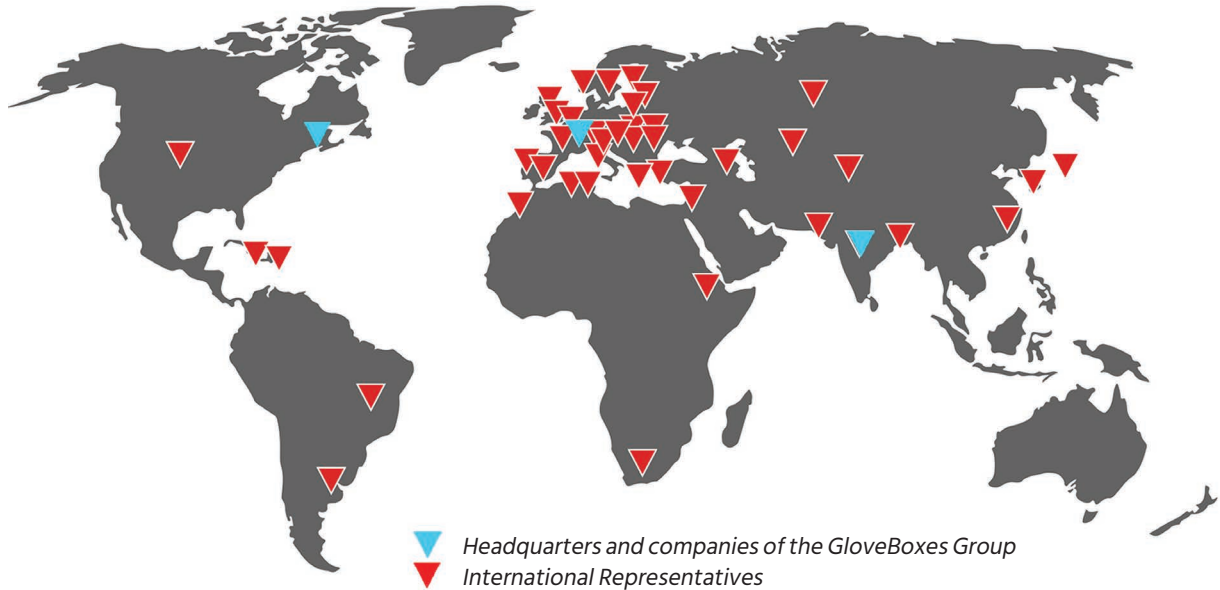

Global presence

15 000 INSTALLATIONS

Ergonomics – Enhanced user experience – Silent functioning
Design and project management – Technical support

60 International Presence COUNTRIES



1990



2000



2020



GLOVE BOXES

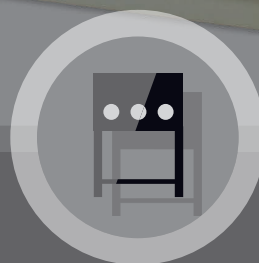

- ▼ Jacomex at a glimpse
- ▼ Standard, modular and customized glove boxes
- ▼ Glove Boxes dimensions

JACOMEX AT A GLIMPSE

A wide range of glove boxes for targeted applications

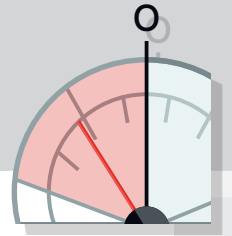

NEGATIVE-PRESSURE HANDLING PROTECTING THE OPERATOR AND ENVIRONMENT AIR OR INERT GAS – HEPA FILTERS



Pages 10-15



Pure

GLOVE BOXES PURE
WITH STAND-ALONE UNIT
< 1PPM H₂O & O₂

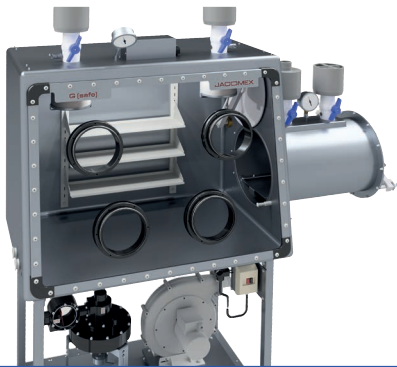

Pages 18-19



Gsafe

HIGH SECURITY
GLOVE BOX
UNDER FILTERED AIR



Page 20



Giso

HIGH SECURITY
ISOLATOR UNDER
FILTERED GAS

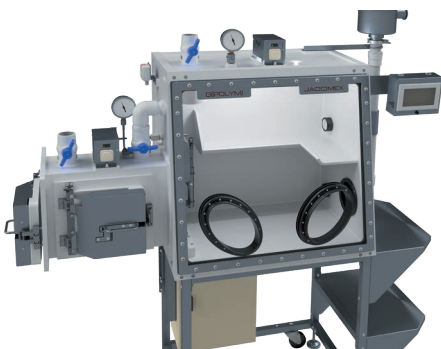

Page 21



Gpolym

GLOVE BOX MADE
OF POLYMER MATERIALS



POSITIVE-PRESSURE HANDLING PROTECTING THE PRODUCT INERT GAS



Pure

GLOVE BOXES PURE
WITH STAND-ALONE UNIT
< 1PPM H₂O & O₂



Pages 10-15



Gbox

GLOVE BOX WITH
COMPACT PURIFICATION UNIT
< 1PPM H₂O & O₂



Pages 16



Gmega

MODULAR GLOVE BOX
UNDER REGULATED
ATMOSPHERE



Page 17



Gpolym

LARGE-VOLUME
MODULAR GLOVE BOX



Page 21

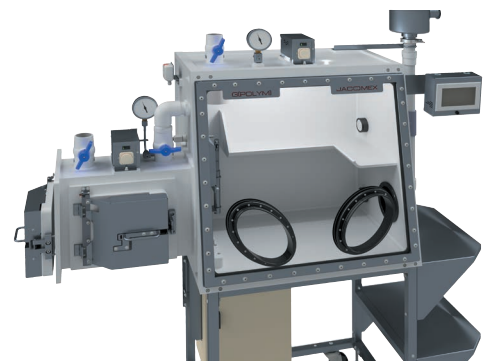



PureSmart

STANDARD GLOVE BOX
WITH STAND-ALONE PURIFICATION UNIT
< 1 PPM H₂O & O₂

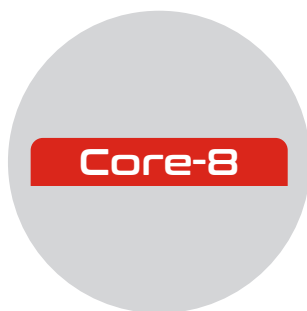

PURIFICATION UNIT



MODULAR EQUIPMENT

- ▼ Single-line H₂O - O₂ stand-alone purification unit
- ▼ Leak rate <10E-5mbar l/s
- ▼ Closed-loop circulation, 90m³/h flow
- ▼ Automatic regeneration
- ▼ Regeneration N₂ or Ar + 3-10% H₂
- ▼ Purification capacity **Core-8**
 - 36 L O₂
 - 1000 g H₂O

Wide range of common equipment and options for all traditional glove boxes applications

- ▼ Mini vacuum chamber Ø 150
- ▼ Solvent trapping
- ▼ Freezer (range down to -40°C)
- ▼ Antistatic solutions
- ▼ Filters
- ▼ Microscopes
- ▼ Feedthroughs

PURIFIED GLOVE BOX : STANDARD RANGE



- For **Academic Research, start-ups** and **industries**
- Protection of quality products for standard needs **under ultra-pure atmosphere**

24/24 Energy-Saving Mode
In standby and in use
During handling



TECHNICAL DATA

- ▼ **Tightness Class 1** according to ISO 10648-2 (oxygen method)
Leak rate < 5.10E-4/h (**0.05 Vol%/h**)
- ▼ EPDM gaskets with high chemical resistance
- ▼ Glovebox - vacuum chamber - piping: stainless steel X2CrNi18-9 (AISI304L)
- ▼ Manual vacuum chamber Ø 400 Length 600 mm
Inner sliding tray - Removable rails
Leak rate <10E-5mbar l/s
- ▼ Front panel: sapphire polycarbonate - laminated mineral glass
- ▼ Polymer glove rings Ø 220 mm - Antistatic gloves
- ▼ Lighting from the ceiling (LED spotlights)
- ▼ 6 stainless steel shelves (height-adjustable)
- ▼ 1 electrical feedthrough 230V + 6 blank feedthroughs for ISO KF40
- ▼ Automatic regulation (positive or negative pressure)
- ▼ Remote stand-alone H₂O - O₂ purification unit
- ▼ 7" HD color touch screen: new intuitive menus, integrated assistance, user management, traceability, graphs and alarms...



ADVANTAGES

- ▼ Pre-equipped modules for plug-and-play extension
- ▼ Short purification circuit - Enhanced performance
- ▼ High purification capacities designed to purify no less than 2 to 3 modules
Purification loads among the most quantitative on the market for equivalent range
- ▼ Pressure regulation without vacuum pump (positive pressure/negative pressure)
- ▼ Comfortable to use - **Quiet**
- ▼ Short delivery time
- ▼ Easy and accessible maintenance
- ▼ Long service life - Low operating costs

POSSIBLE APPLICATIONS...

- ▼ Storing
- ▼ Preparation
- ▼ Scaling
- ▼ Chemical reactions and synthesis
- ▼ Organometallic chemistry
- ▼ Material Science
- ▼ Chromatography
- ▼ Experiments under strict anaerobic
- ▼ Parts assembling
- ▼ Crystallography
- ▼ Electrochemical assembling and tests

NEW HMI INTERFACE

- ▼ High definition 7" display with great legibility
- ▼ Intuitive navigation with a lot of user-friendly menus
- ▼ Adjustable parameters, continuous recording and graphs
- ▼ Integrated PLC assistance and maintenance for clear and optimal operating and ease of use



PureMod

MODULAR GLOVE BOX
WITH STAND-ALONE PURIFICATION UNIT
< 1PPM H₂O & O₂

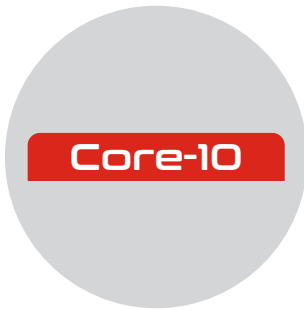
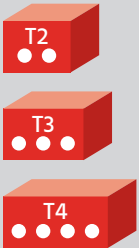

PURIFICATION UNIT



FLEXIBILITY AND MODULARITY

- ▼ Single-line H₂O - O₂ stand-alone purification unit
- ▼ Leak rate <10E-5mbar l/s
- ▼ Closed loop circulation - Adjustable flow rate 0-120m³/h
- ▼ Automatic regeneration
- ▼ Regeneration N₂ or Ar + 3-10% H₂
- ▼ Purification capacity **Core-10**
 - 45 L O₂
 - 1250 g H₂O

- Workstation: single-sided - double-sided
Numerous options for all processes in R&D and production
- ▼ Mini vacuum chamber Ø 150
 - ▼ Mini heating vacuum chamber Ø 150
 - ▼ T-shaped vacuum chamber
 - ▼ Solvent trap
 - ▼ Freezer (range down to -40°C)
 - ▼ Anti-static solutions
 - ▼ Filters
 - ▼ Microscopes
 - ▼ Feedthroughs

▼ Data on purification systems p24 - 26

PURIFIED GLOVE BOX: MODULAR RANGE



- **Excellent performance** for any industrial or experimental development requiring modularity and high purity of the atmosphere.
- Recommended for the integration of scientific instrumentation, measurement and analysis devices and in process improvement.

24/24 Energy-Saving Mode
In standby and in use
During handling



TECHNICAL DATA

- ▼ **Tightness Class 1** according to ISO 10648-2 (oxygen method) Leak rate <math>< 5.10E-4/h</math> (0.05 Vol%/h)
- ▼ EPDM gaskets with high chemical resistance
- ▼ Glovebox - vacuum chamber - piping: stainless steel X2CrNi18-9 (AISI304L)
- ▼ Programmable automatic vacuum chamber \varnothing 400 Length 600 mm
Inner sliding tray - Removable rails
Leak rate <math>< 10E-5\text{mbar l/s}</math>
- ▼ Front panel: sapphire polycarbonate - laminated mineral glass
- ▼ Polymer glove rings \varnothing 220 mm - Antistatic butyl gloves
- ▼ Lighting from the ceiling (LED spotlights)
- ▼ 6 stainless steel shelves (height-adjustable)
- ▼ 1 electrical feedthrough 230V + 6 blank feedthroughs for ISO KF40
- ▼ Automatic regulation (positive or negative pressure)
- ▼ Remote stand-alone H_2O - O_2 purification unit
- ▼ 7" HD color touch screen: new intuitive menus, integrated assistance, user management, traceability, graphs and alarms...



ADVANTAGES

- ▼ Versatility: flexible standard design
- ▼ **Customized project management - The basic essentials**
Technical support, simulation on 3D drawings, verification of the technical and ergonomic layout.
- ▼ Short purification circuit - Optimised performance
- ▼ Increased purification capacities designed for larger volumes and longer regeneration times
Purification loads among the most quantitative on the market for equivalent range.
- ▼ Pressure regulation without vacuum pump (positive pressure/negative pressure)
- ▼ Comfortable to use - **Quiet**
- ▼ Easy and accessible maintenance
Long service life - Low operating costs

NEW HMI INTERFACE

- ▼ High definition 7" display with great legibility
- ▼ Intuitive navigation with a lot of user-friendly menus
- ▼ Adjustable parameters, continuous recording and graphs
- ▼ Integrated PLC assistance and maintenance for clear and optimal operating and ease of use

POSSIBLE APPLICATIONS...

- ▽ Materials science and polymers
- ▽ Synthesis chemistry
- ▽ Assembly and characterisation of lithium-ion batteries
- ▽ Biology and all kind strong anaerobic atmospheres
- ▽ Innovative materials, materials chemistry, silicone chemistry
- ▽ Welding of titanium parts for the aeronautics industry.



PureEvo

PREMIUM CUSTOM GLOVE BOX
WITH STAND-ALONE PURIFICATION UNIT
< 1PPM H₂O & O₂

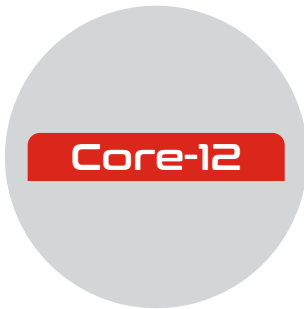
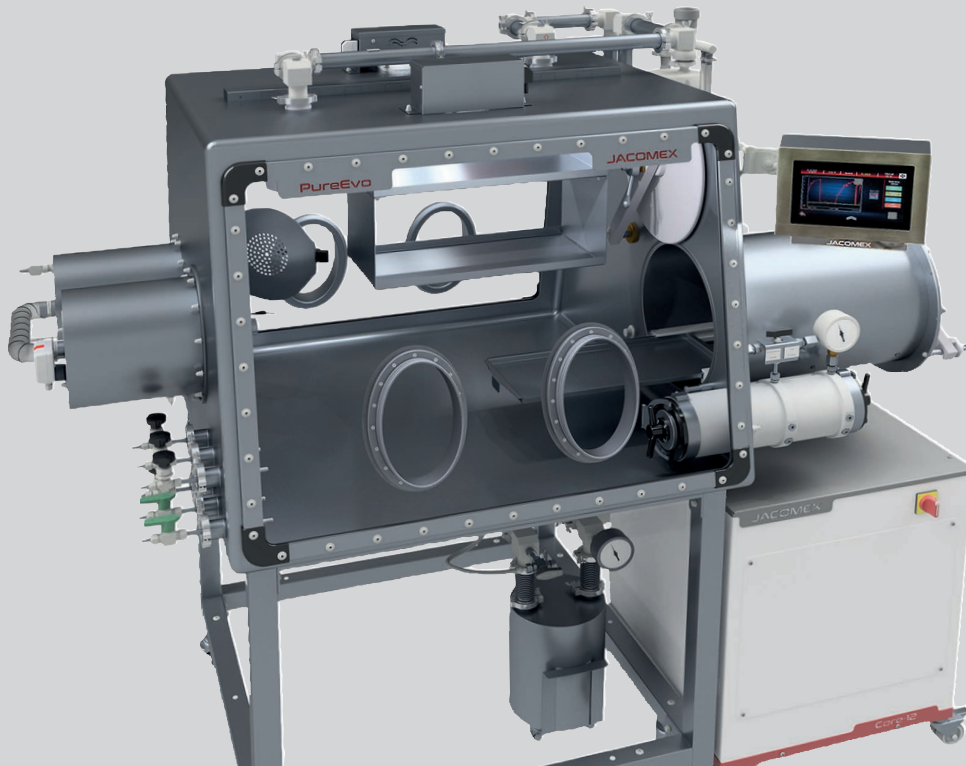

PURIFICATION UNIT



LIMITLESS CUSTOMIZATION

- ▼ Single line **H₂O - O₂** stand-alone purification unit
- ▼ Leak rate <10E-5mbar l/s
- ▼ Closed loop circulation - Adjustable flow rate 0-120m³/h
- ▼ Automatic regeneration
- ▼ Regeneration N₂ or Ar + 3-10% H₂
- ▼ Purification capacity **Core-12**
 - 55 L O₂
 - 1500 g H₂O
- ▼ Options: double-line **H₂O - O₂** stand-alone purification units

- Design and operating adapted to any specific or complex processes
- ▼ Interconnectable glove boxes modules
- ▼ Customized dimensions and shapes
- ▼ 100% compatible with all options and equipment at JACOMEX
- ▼ Flexible and scalable design.
Designed for the integration of simple and sophisticated machinery and instrumentation
- ▼ Standard configuration and options
 - **Design:** 100% removable - rounded corners
 - **Surface finish:** satin - electropolished
 - **Stainless steel quality:** AISI 304L - AISI 316L (1.4306) (1.4404)

▼ Data on purification systems p24 - 26

PURIFIED GLOVE BOX: PREMIUM AND FULLY CUSTOMIZABLE



- **High Purity and Special Design** adapted to any specific project, scientific and industrial process in development or at pilot stage
- Recommended for mass production and characterisation under pure atmosphere, integration of equipment and machines as well as processes requiring configurable controls, automation and safety

24/24 Energy-Saving Mode
In standby and in use
During handling



TECHNICAL DATA

▼ Tightness Class 1 according to ISO 10648-2 (oxygen method) Leak rate < 5.10E-4/h (0.05 Vol%/h)
▼ EPDM gaskets with high chemical resistance
▼ Glovebox - vacuum chamber - piping: stainless steel X2CrNi18-9 (AISI304L)
▼ Programmable automatic vacuum chamber Ø 400 Length 600 mm Inner sliding tray - Removable rails Leak rate <10E-5mbar l/s
▼ Front panel: sapphire polycarbonate - laminated mineral glass
▼ Polymer glove rings Ø 220 mm - Antistatic butyl gloves
▼ Lighting from the ceiling (LED spotlights)
▼ 6 stainless steel shelves (height-adjustable)
▼ 1 electrical feedthrough 230V + 6 blank feedthroughs for ISO KF40
▼ Automatic regulation (positive or negative pressure)
▼ Remote stand-alone H ₂ O - O ₂ purification unit
▼ 10" HD color touch screen: new intuitive menus, integrated assistance, user management, traceability, graphs and alarms...



ADVANTAGES

- ▼ Flexibility - Ability to integrate equipment and machinery
- ▼ **Customized project management - Information Folder** technical support, 3D drawings simulation, technical and ergonomic setup approval
- ▼ 4 large-capacity purification models available: Core-12, Core-24P, Core-24S, P(sys)-IV
Processing of larger volumes, severe or tricky conditions, regenerations at widely spaced intervals
Purification loads among the most quantitative on the market for equivalent range.
- ▼ Pressure regulation without vacuum pump (positive pressure/negative pressure)
- ▼ Comfortable to use - **Quiet**
- ▼ Easy and accessible maintenance
- ▼ Long service life - Low operating costs
- ▼ **Hazardous inert atmospheres:** (operating in negative pressure): address us for designing a fitted security configuration (specific equipment recommended).

NEW HMI INTERFACE - HD 10" DISPLAY: even larger for greater ergonomics

- ▼ Intuitive navigation with a lot of user-friendly menus
- ▼ Adjustable parameters, continuous recording and graphs
- ▼ Integrated PLC assistance and maintenance for clear and optimal operating and ease of use
- ▼ Configurable indicator light. All features on our separate brochure

POSSIBLE APPLICATIONS...

- ▼ Materials physics and nanotechnologies
- ▼ Powder processes
- ▼ Development of all-solid-state batteries and lithium alternatives
- ▼ Oven processes (treatment, sintering, annealing)
- ▼ Organic electronic materials: 2nd and 3rd generation solar cells (thin films, perovskites, multijunction, DSSC...), Quantum Dots, graphene and 2D materials.
- ▼ Welding of large parts in titanium and alloys for the aeronautical, naval and automotive industries
- ▼ Research and control of experiments on nuclear materials, sensitive to atmospheric components



Gbox

MODULAR GLOVE BOX
UNDER REGULATED ATMOSPHERE



REGULATED GLOVE BOX

- For **scientific** and **industrial** applications
- Regulated and climatic **custom** glove boxes
- Glove boxes **under pure inert gas (%)** operating in negative pressure

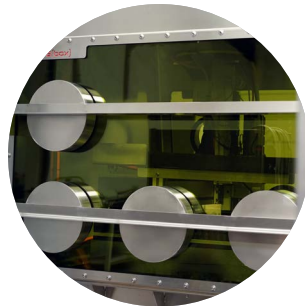
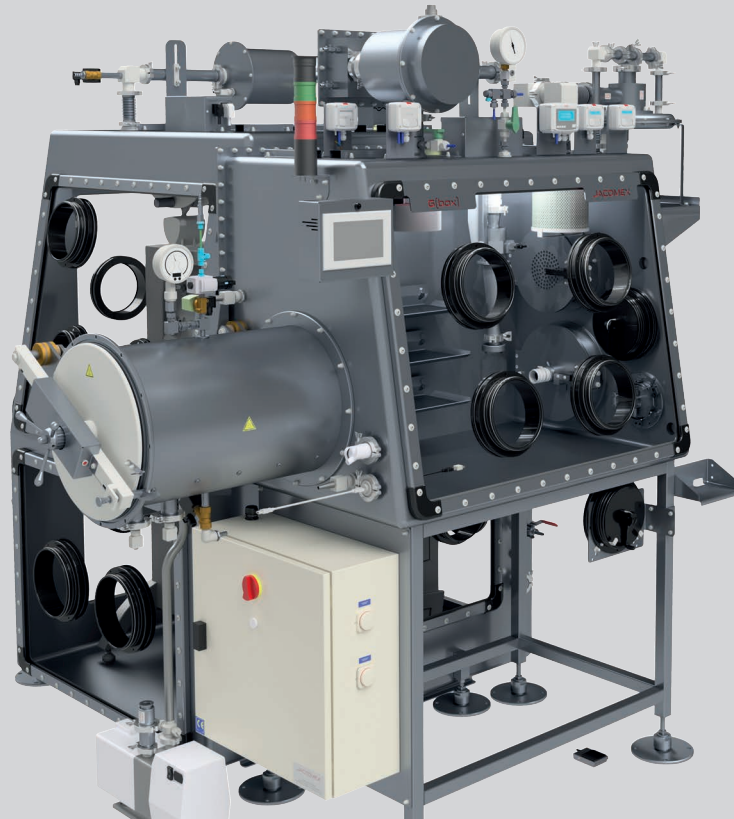

ADVANTAGES

- ▼ Flexible and easily upgradable design
- ▼ Standard and custom models
- ▼ Possible connection with other range of JACOMEX glove boxes
- ▼ Ideal for controlled atmospheres with automatic regulation of moisture (0-70%RH) and/or oxygen (<1%O₂)
- ▼ Wide range of transfer systems
- ▼ 3D design drawings

POSSIBLE APPLICATIONS...

- ▽ Configurable climatic chambers:
 - Moisture (% RH): drying and/or humidification
 - Temperature: heating and/or air-conditioning
- ▽ Development of Perovskite photovoltaic cells (PSC)
- ▽ Low-oxygen reducing atmospheres against flammability or explosiveness (chemical substances, powders...)

TECHNICAL DATA

- ▼ Tightness class 1 according to ISO 10648-2 (oxygen method)
Leak rate < 0.05 Vol%/h
- ▼ Silicon-free gaskets (removable panels)
- ▼ Chamber: stainless steel X2CrNi18-9 (AISI 304 L)
- ▼ Front panel: polycarbonate – mineral laminated glass
- ▼ Roof lighting (LED spotlights)
- ▼ Height adjustable stainless steel shelves
- ▼ 1 electrical feedthrough 230V + 2 ISO KF40 blank feedthroughs
- ▼ Automatic pressure regulation
- ▼ Compatible with all JACOMEX options and equipment



Gomega

LARGE-VOLUME MODULAR
GLOVE BOX



MODULAR GLOVE BOXES

- Under purified controlled atmosphere for industrial applications and production



ADVANTAGES

- ▼ Based on Meccano® system, robust, dedicated to industrial manufacturing
- ▼ Combinable elements: can yield endless custom solutions based on standard components
- ▼ Easy-removable mechanical design for:
 - fast and easy maintenance of internal production machines and tools
 - installations relocation
 - components recycling in case of reconfiguration or extension

POSSIBLE APPLICATIONS...

- ▽ Additive Manufacturing
- ▽ Aeronautics
- ▽ Integration of industrial robots
- ▽ Machines and processes securing under reducing atmosphere
- ▽ Cowling of installations or assembly-lines under anti-oxidizing and/or low-hygrometry atmosphere

TECHNICAL DATA

- ▼ Tightness class 1 according to ISO 10648-2 compatible with purified inert atmospheres
- ▼ Stainless steel profiles X2CrNi18-9 (US 304 L)
- ▼ All dimensions by 100 mm increments in all 3 dimensions
- ▼ Volumes until 150m³ – Unlimited lengths
- ▼ EPDM gaskets
- ▼ Panels: polymer – mineral laminated glass – stainless steel
- ▼ Access and transfer: vacuum chamber, doors, hatches, intervention airlock...



Gsafe

HIGH SECURITY GLOVE BOX
UNDER FILTERED AIR

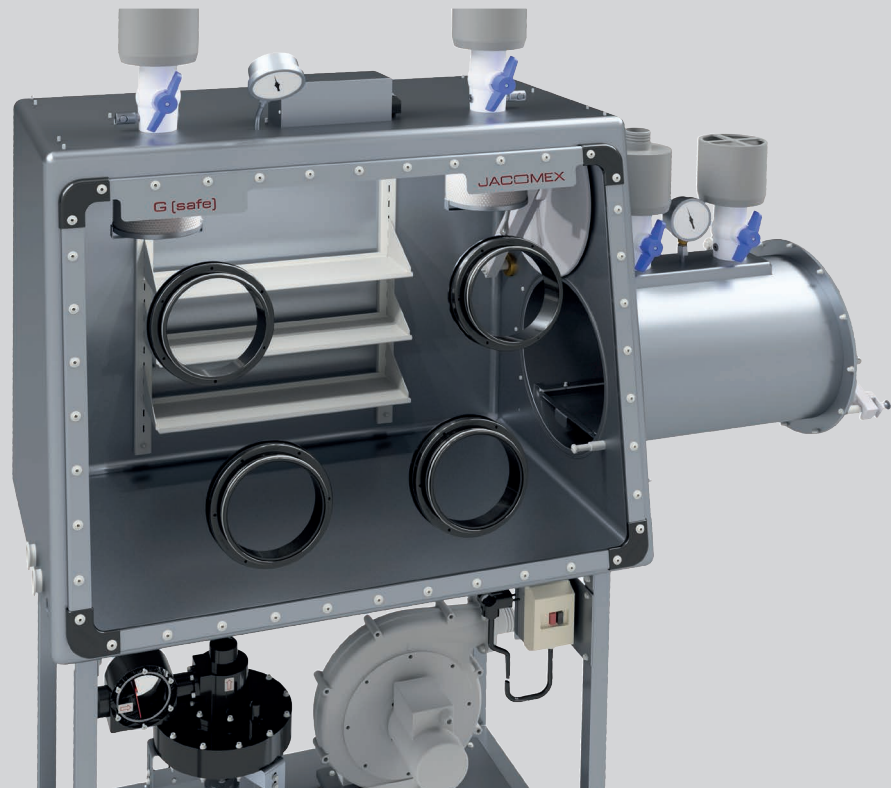

NUCLEAR: RADIOPROTECTION

- ▼ Design
 - Stainless steel: AISI 316L
 - Design: rounded corners
 - Surface finish: polished – electropolished
- ▼ Transfer systems
 - Airlock chamber – Bag rings - RTP
- ▼ Protection equipment
 - **Particules:** H13 filters nuclear grade
 - **Radioiodine:** activated charcoal, Ki impregnated
 - **Biological protection:** according to activity level and process – glass panels or lead-acrylic
 - **Operator safety:** pressure control and safety valve



INDUSTRY - RESEARCH: CMR, TOXIC FUMES, MICRO POWDERS, NANOPARTICLES

- ▼ Design
 - Stainless steel: AISI 304L - 316L
 - Design: modular – rounded corners
 - Surface finish : polished – electropolished
- ▼ Transfer systems
 - Airlock chamber – Bag rings - RTP
- ▼ Protection equipment
 - **Particules:** filters H13-H14
 - **Solvents:** activated charcoal
 - **Toxic fumes :** activated charcoal (specific impregnation)
 - **Working panel:** quick-opening mineral glass lifting panel or polycarbonate sapphire
 - **Operator safety:** pressure control and safety valve



HIGH SECURITY GLOVE BOXES

- For a reliable **operator** and **environment** protection

TECHNICAL DATA

▼ Tightness class 1 according to ISO 10648-2 (oxygen method) Leak rate < 0.05 Vol%/h
▼ Gaskets: nitrile (modular design) EPDM (rounded corners)
▼ Chamber: stainless steel X2CrNi18-9 / AISI 304 L (option 316L)
▼ Front panel: polymer – mineral laminated glass
▼ 1 pressure gauge
▼ Roof lighting (LED spotlights)
▼ Height adjustable stainless steel shelves
▼ 1 electrical feedthrough 230V + 2 ISO KF40 blank feedthroughs
▼ Glove rings: polymer – stainless steel
▼ Gloves: Butyl – CSM – EPDM – Polychloroprene - Latex
▼ Negative pressure is automatically maintained and a security flow is automatically triggered in case of containment breach (regulation valve option)

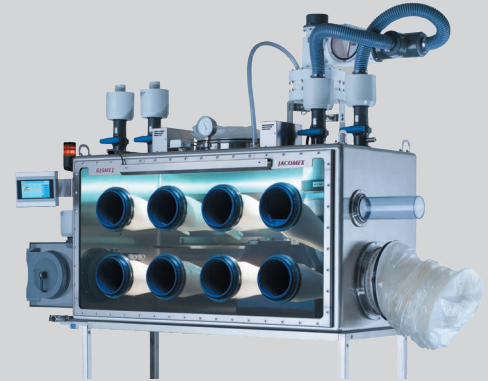

Nuclear glove box on analysis line
[Safeguards Analytical Labs - IAEA]



Nuclear glove box with safety valve and biological lead glass protection

ADVANTAGES

- ▼ Flexible and easily upgradable according to use
- ▼ **Customized project follow-up:**
Technical support, 3D drawings simulation, technical and ergonomic setup approval.
- ▼ Versatility
- ▼ Level of security adaptable according to products dangerousness and manipulated substances
- ▼ Optimal protection of the operator and environment thanks to JACOMEX valves
- ▼ The wide range of equipment and options allow to answer all your requirements

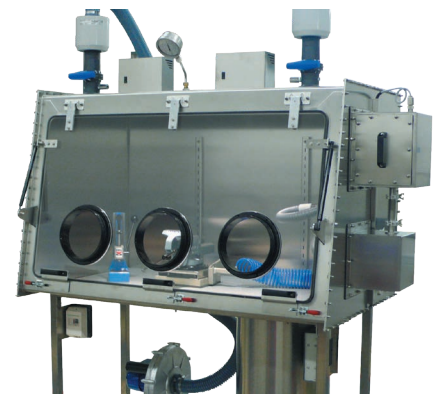

Glove box for Industry:
maintenance and secured recycling of asbestos waste [aeronautics]

HIGH SECURITY ISOLATOR UNDER FILTERED INERT GAS

ISOLATOR

- **Technicity, performances and enhanced finishing** for demanding processes
- **Available options:**
 - Laminar flow
 - Bio-decontamination H₂O₂
 - O₂ Purification (anaerobia 1ppm)
- **Normative framework:**
 - Compliance with ISO 14644-1, ISO 10648-2.
 - Engineering (GEP) and manufacturing (GMP) compliance
 - Compliance with FDA 21CFR part.11 and computerised systems GAMP5



TECHNICAL DATA

- ▼ **Tightness class 1** according to ISO 10648-2 (oxygen method) Leak rate < **0.05 Vol%/h**
- ▼ Gaskets: EPDM – silicone FDA
- ▼ Rounded corners chamber: stainless steel AISI 304L – AISI 316L Surface finish: electropolished
- ▼ Front panel: mineral laminated glass
- ▼ Roof lighting (LED spotlights)
- ▼ Easy-to-clean stainless steel shelves
- ▼ 1 electrical feedthrough 230V + 2 ISO KF40 blank feedthroughs
- ▼ Glove rings: stainless steel
- ▼ Interface: 7" colour touch-screen
- ▼ Automatic pressure regulation

ADVANTAGES

- ▼ Custom design
- ▼ Operators-products-environment protection
- ▼ **Customized project follow-up:** Technical support, 3D drawings simulation, technical and ergonomic configuration approval
- ▼ Equipment fully adjustable according to the application:
 - Filters: HEPA H13-H14 or ULPA
 - Transfer systems: airlock – bag-in-bag-out – RTP
 - Controlled atmosphere: moisture (0-70%RH) and/or oxygen control
 - Operator security: JACOMEX pressure regulation and security valve
 - Particulate cleanliness according to ISO 14644-1 (class ISO5 when not operating)

POSSIBLE APPLICATIONS...

- ▼ Quality control, Galenic R&D
- ▼ Scaling and packaging of toxic and hygroscopic powders
- ▼ Chemical synthesis and manipulation of active principles, cytotoxic and OEB4 – OEB5 products
- ▼ Surgical implants manufacturing for the medical field
- ▼ Development of nanoparticulate anti-cancer active ingredients
- ▼ Microbiome science



Gpolym

GLOVE BOXES
MADE OF POLYMER MATERIALS



VERSATILE GLOVE BOXES

- **A specific use for each type of plastic:** acids, solvents, radiations resistant; mechanical resistance; optical, thermal, hygienic properties, weight...

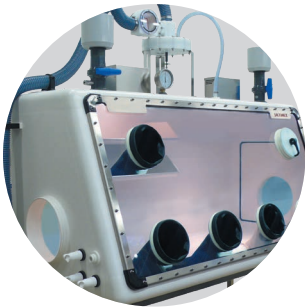

ADVANTAGES

- ▼ Choice of material: Corian, PMMA, PVC, PE
- ▼ Flexibility: options and equipment fitted to you application
- ▼ Dimensions: standard and custom

POSSIBLE APPLICATIONS...

- ▽ Polymer glove boxes can be used for most of the applications related to operators or products protection

TECHNICAL DATA

- ▼ **Tightness class 1** according to ISO 10648-2 (oxygen method) Leak rate **< 0.05 Vol%/h**
- ▼ Removable front panel: PMMA, polycarbonate, PVC, mineral laminated glass
- ▼ Roof lighting (LED spotlights)
- ▼ 1 electrical feedthrough 230V + 2 ISO KF40 blank feedthroughs
- ▼ Automatic pressure regulation

CORIAN : A MULTI-BENEFIT MATERIAL

- ▼ Frequently used by health facilities, Corian is a polymer material renowned for its lifespan, resistance to shock and chemicals and its hygienic and antibacterial properties
- ▼ Its opaque and luminous aspect, well appreciated for glove boxes, greatly participates to the working comfort

DIMENSIONS AND DESIGN: PURE RANGE

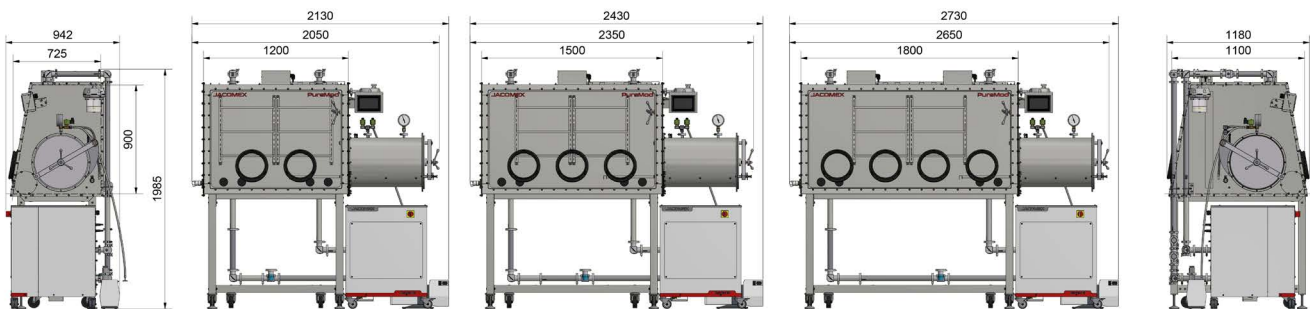
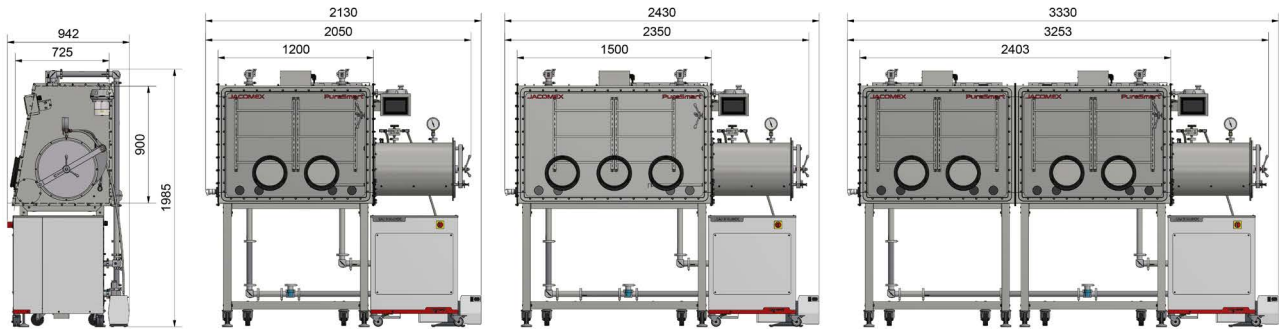

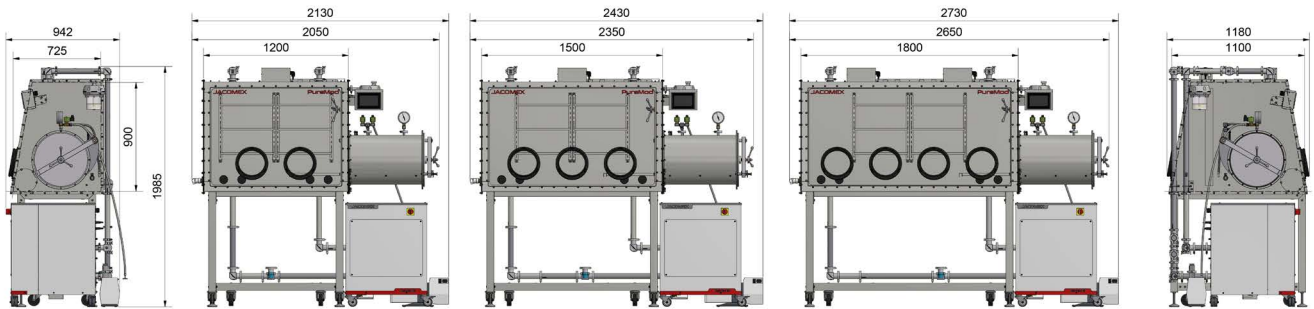
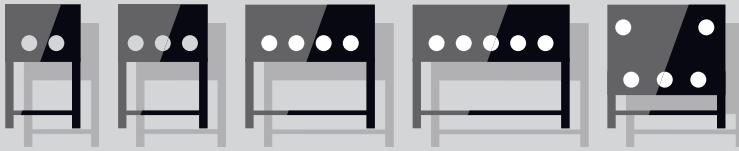

CLASSIC DESIGN

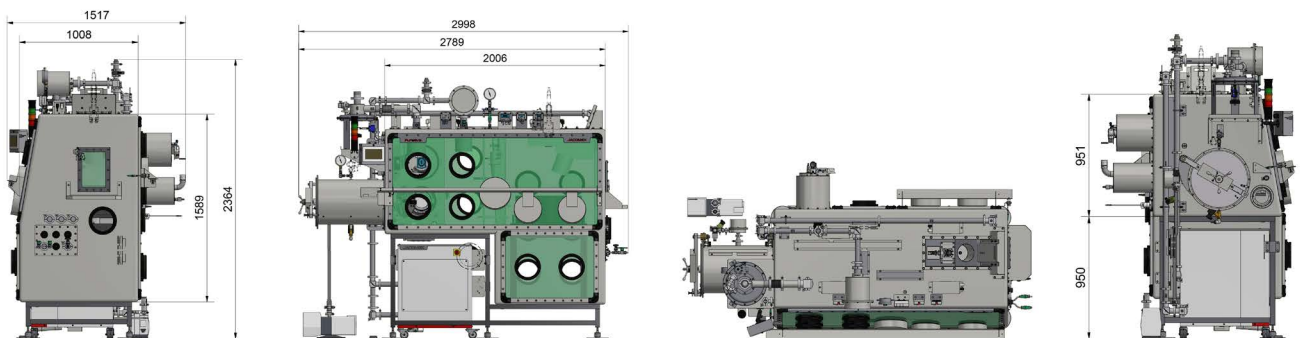

CUSTOM DESIGN (EXEMPLE)

DESIGN OFFICE 3D DRAWINGS

- ▽ Custom glove boxes
- ▽ Specific Projects
- ▽ Simulations

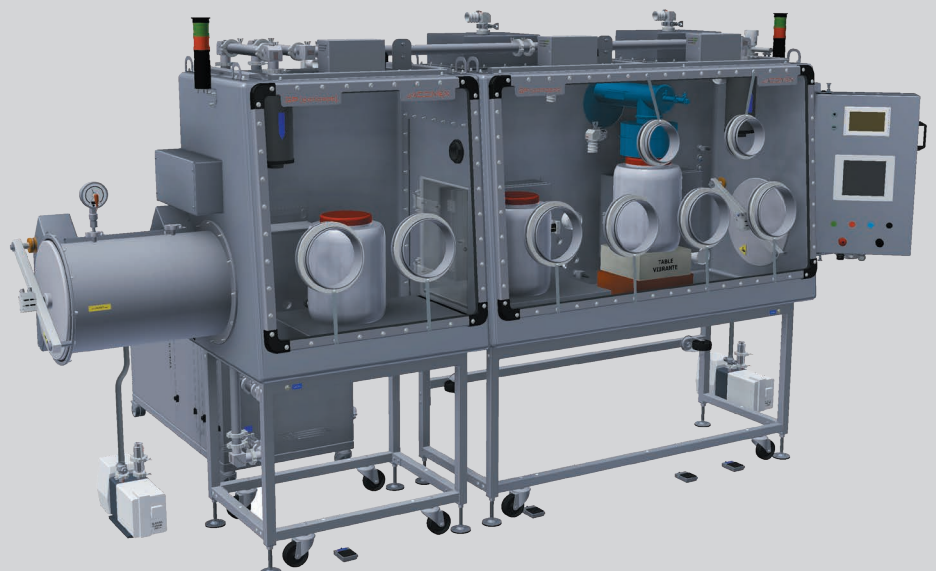



Pure

< 1 PPM H₂O & O₂



PURE-RANGE GLOVE BOXES
PURIFICATION UNITS FOR CONTROLLED ATMOSPHERES

REMOVAL OF H₂O AND/OR O₂ FROM INERT GAS (Ar/N₂/He)

▼ JACOMEX systems offer a unique technical strength, known as one of the best, ensuring a stable pure atmosphere over time with spaced regeneration steps.

THE ADVANTAGES

- ▼ Substantial gas saving
- ▼ Automatic regeneration (N₂-Ar mix.3-10% H₂)
- ▼ Stable purity over time without regeneration nor maintenance
- ▼ Automatic pressure regulation without vacuum pump
- ▼ Silent functioning (noise level <50dB)

COMPARED DATA

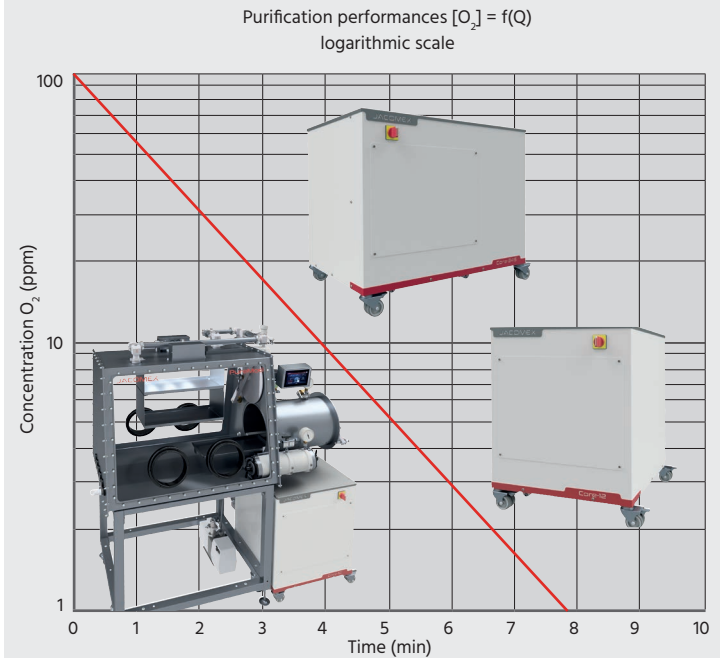

Technical Data	PURESMART CORE-8	PUREMOD CORE-10	PUREEVO CORE-12	PUREEVO CORE-24P	PUREEVO CORE-24S
St.Steel Glovebox AISI 304L Thickness 3 mm Tightness class 1 ISO 10648-2	✓	✓	✓	✓	✓
Energy-Saving Mode	✓	✓	✓	✓	✓
Operating mode : positive and negative pressure	✓	✓	✓	✓	✓
Modular users management	✓	✓	✓	✓	✓
Report writing	✓	✓	✓	✓	✓
Help hands-in-gloves	✓	✓	✓	✓	✓
Vacuum pump 2 stages 21m ³ /h (Limit Press. 5.10-4 mbar)	✓	✓	✓	✓	✓
Automatic vacuum chamber with adjustable parameters	●	✓	✓	✓	✓
Glovebox tightness self-test	●	✓	✓	✓	✓
Blower with variable flow		✓	✓	✓	✓
Customized project follow-up		✓	✓	✓	✓
Custom Design / Process integration			✓	✓	✓
Alarm inert gas missing/failure	●	●	●	●	●
Double sided working area		●	●	●	●
Adjustable automatic glovebox flushing based on H ₂ O / O ₂ values		●	●	●	●
Heated mini vacuum chamber Ø150 mm		●	●	●	●
Vacuum chamber with interlocked doors Ø400 mm		●	●	●	●
Glovebox Design: high cleanability			●	●	●
Glovebox Design: electropolishing - surface coating			●	●	●
Purifier by-pass with automatic purification start (auto-start)			●	●	●
Electronic gauge with vacuum-interconnected cycling			●	●	●
Heated vacuum chamber Ø400 mm			●	●	●
HMI Touch Panel size	7"	7"	10"	10"	10"
Modularity - Integration flexibility	+	++	++++	++++	++++

✓ Standard ● Option

INERT GAS PURIFICATION UNITS



H₂O & O₂
< 1 PPM



- ▼ A wide range of purifiers
- ▼ Appropriate technical choices
- ▼ Performant systems

TECHNICAL DATA

- ▼ PLC-controlled purification unit
- ▼ Colour touch screen interface: continuous monitoring and recording of functional data
- ▼ Automatic regeneration N_2 / Ar / He + H_2
- ▼ Leakage rate $<10E-5$ mbar l/s
- ▼ Closed loop circulation
- ▼ Configurable H_2O and O_2 alarms
- ▼ Configurable automatic gas flushing
- ▼ USB and Ethernet ports: data export and remote control

SINGLE-LINE PURIFIERS

Core-8

- ▼ Circulation flow: $90m^3/h$
- ▼ Capacities : 36L O_2 - 1000g H_2O

Core-10

- ▼ Variable circulation flow: max. $120m^3/h$
- ▼ Capacities: 45L O_2 - 1250g H_2O

Core-12

- ▼ Variable circulation flow: max. $120m^3/h$
- ▼ Capacities : 55L O_2 - 1500g H_2O

DOUBLE-LINE PURIFIERS

Core-24P

- ▼ Variable circulation flow : max. $120m^3/h$
- ▼ Capacities: 110L O_2 - 3000g H_2O
- ▼ Avantages : Continuous purification
Ready-to-use purification tank

Core-24S

- ▼ Variable circulation flow: max. $120m^3/h$
- ▼ Capacities : $>280L O_2$ - 3000g H_2O
- ▼ Avantages : boosted capacities
Purification of large volumes
Safety for oxygen-highly-sensitive processes



CUSTOM GAS PURIFICATION UNITS

Core-64P Core-64S

STANDARD MODULAR PURIFICATION UNITS

Four-models reactors that can run as independent or combined modules:

- ▼ Recommended for large volumes and G[mega] glove boxes
- ▼ By-pass line and automated analysis circuit
- ▼ Air or water exchanger

Core-64P 2x double purifying lines

TECHNICAL DATA

- ▼ Purification of volumes until 20m³
- ▼ Two parallel lines (4 purifiers)
- ▼ Continuous purification even during purification phases
- ▼ Capacity per line > 560L O₂ - 3900g H₂O

Core-64S 2x double purifying lines

TECHNICAL DATA

- ▼ Purification of volumes until 40m³
- ▼ Two lines assembled in series (4 purifiers)
- ▼ Over-boosted H₂O and O₂ purification capacity
- ▼ Total capacity > 1120L O₂ - 7800g H₂O

EXPERTISE

GAS PURIFICATION AND MANAGEMENT

Jacomex expertise allows us to answer your specific needs while taking critical parameters into account:

- ▼ Volume, number of gloves, glove box leak rate
- ▼ Internal process, materials and products handled.
- ▼ Application field, research, production
- ▼ Risks analysis and security constraints
- ▼ Running and maintenance costs

LARGE-VOLUME PURIFICATION UNITS





PureTrap

SOLVENT TRAPPING

STAND-ALONE UNITS WITH LARGE CAPACITIES FOR ORGANIC SOLVENT REMOVAL

DISCONNECTABLE ACTIVATED CARBON SOLVENT TRAP

EFFICIENT - AUTONOMY

Activated charcoal with standard or specific impregnation for targeted pollutants (HF, acids, hydrocarbons...).

For Chemistry and Physics.

Capacity : ~ 700 g solvents (vapour)

Advantage: disconnection of the trapping unit without pollution of the circuit. Replacement of the load can be proceeded in a safe area.

MOLECULAR SIEVE SOLVENT TRAPPING

REGENERABLE - AUTONOMY

Removal of the loads at longer intervals.

Capacity : ~ 900 g solvents (vapour)

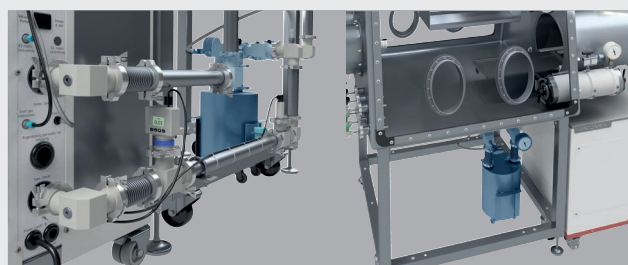

COV ANALYZERS

Optional COV analyzers increase the security level by allowing real time control of the solvent trapping.



PURE SOLV inert

SOLVENT PURIFICATION SYSTEM

SOLVENT PURIFICATION UNIT WITH GLOVE BOX DISPENSING

TECHNICAL DATA

- ▼ Safety cabinet according to EN 14470-1 and EN 1363-1 norms with high and low ventilation. Flange for connection to an extraction
- ▼ Purification and solvent dispensing in laboratory glassware and glove boxes. Purification system for 5 different solvents (to be specified for each project)
- ▼ Double line purification columns, capacity 10L/line
- ▼ Frame, purification columns, stainless steel support AISI 316L
- ▼ Purification capacities 800L before regeneration/removal
- ▼ Adjustable flow until 1L/min
- ▼ Secured AISI 304L stainless steel tanks, capacity 18L with fast ROTAREX connections at gas input and solvents output, valves and safety valves
- ▼ Retention tray under the tanks
- ▼ PTFE flexible and hard AISI 316L stainless steel piping.
- ▼ Pressure and vacuum manometer
- ▼ Gas input security valve
- ▼ 9µ-filter at purification output
- ▼ 0-6 bar independent pressure regulator for each purification line
- ▼ Membrane vacuum pump with a 20L/min flow, vacuum limit 8mbar absolute

A wide range of SPS for the purification of 2-7 solvents. Also available in Benchtop Micro version.



OUR PROJECTS

Protecting the Environment
Protecting the Person
Protecting the Product

JACOMEX

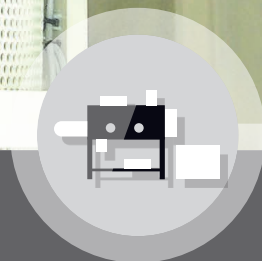

- ▼ Modular glove boxes
- ▼ Custom glove boxes
- ▼ Large-dimensional glove boxes



Biology, Organometallic Chemistry, Material Science,
Lithium Batteries... We know your specific problematics!

CHEMISTRY BIOLOGY

- ▼ Research and characterization of enzymes related to proteins study for therapeutic applications (antibacterial)
- ▼ **GP[concept]T2** anaerobic-glove box with air-conditioning and freezer

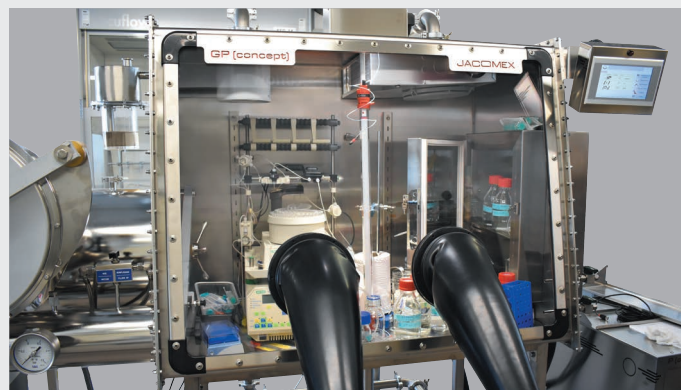

ANALYSIS & MATERIALS

- ▼ Characterization of materials within the frame of studies on electrochemical energy storage. Research of new hybrid organic and polymer materials for the energy
- ▼ **GP[concept]T4** argon-glove box with TGA thermo-gravimetric balance on anti-vibration table and inner air-conditioning



LITHIUM BATTERIES

- ▼ Development of new liquid electrolytes (salt synthesis, additives and solvents) for advanced lithium-ion batteries and new solid electrolytes (polymers and ceramics synthesis) for all-solid-state lithium batteries of 2nd generation
- ▼ **GP[concept]T5** argon-glove box





Turn-key and custom solutions in Physics and Chemistry for the development and characterization of electronic devices and organic materials.

ORGANIC ELECTRONICS

- ▼ Synthesis and development of functional materials, TT-combined polymers and copolymers for Organic Electronics
- ▼ Glove box with two thin film deposition systems for the evaporation of organic and metallic materials

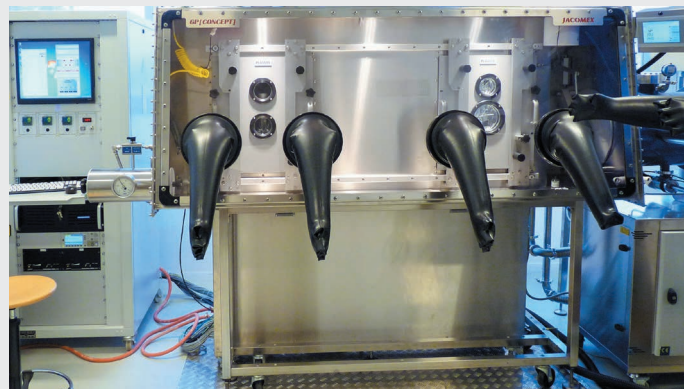

BATTERIES

- ▼ Glove box connected on the load-lock chamber of a TFD equipment by magnetron cathodic sputtering. The equipment allows the deposition of lithium-based materials for batteries applications



PEROVSKITE PHOTOVOLTAIC CELLS

- ▼ Solar cells development: deposition by spinning of Perovskite and Spiro-OMeTAD and thin film gold deposition by evaporation for electrical contacts.
- ▼ Line of glove boxes among which one is dedicated to moisture level control (0-70% RH) in a clean room class 1000

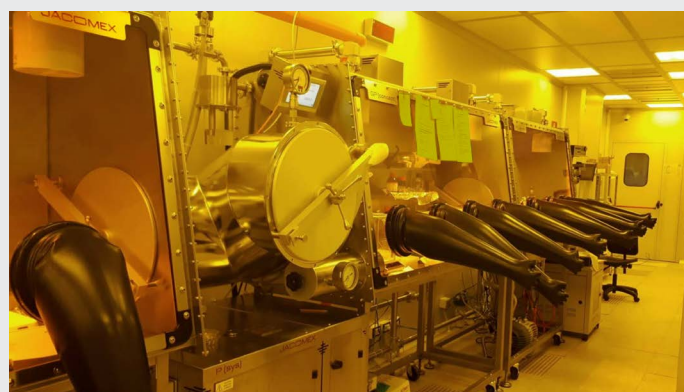



FINE CHEMISTRY - PROTECTION OF OPERATORS

- ▼ Gloveboxes operating in negative pressure under air and nitrogen with HEPA filtration.
- ▼ For analysis, transfer and packaging of toxic powders, HP-APIs and CMR.
- ▼ Vacuum cleaner and safe waste disposal.
- ▼ Hinged front panel and rounded corners for easy cleaning of the enclosure.
- ▼ Valve for automatic regulation of the negative pressure and safety flow in case of containment failure.

INDUSTRY - POWDER TRANSFERS

- ▼ Re-conditioning of pyrophoric powders under controlled atmosphere
- ▼ Safe transfer and removal of powders
- ▼ Hermetic connection of bags and drums
- ▼ Sampling, weighing and operating in ATEX conditions
- ▼ Automated vertical transfer chambers
- ▼ Cleanable working space and integrated vacuum cleaner

DEPOWDERING IN ADDITIVE MANUFACTURING

POWDER SHIELD inert

- ▼ Safe post-processing of additive-manufactured parts
- ▼ Quick opening the front door, perforated floor and gravity-fed powder chute
- ▼ Configurable concept according to use: 4 models with modular and scalable design.
- ▼ Options: unidirectional flow, rotating tilt table, suction pipe, regenerative argon blow-off gun, ultrasonic vibration, powder filtration, cyclonic filtration, distribution nozzle, vacuum hose, sieve integration, gas purification and O₂+H₂O %ppm analysers

Many processes use fine powders that may be hazardous to health or are reactive to the ambient air. We integrate machines, instruments in the desired atmosphere with the appropriate safety equipment.





TITANIUM WELDING

- ▼ Welding of titanium parts for the aeronautics.
- ▼ Big main vacuum chamber for transferring very long titanium parts (welding of in-flight refuelling poles for the Rafale aircraft).
- ▼ Multi-zone welding areas with mobile protective screens. Ergonomic glove rings and built-in welding torches.
- ▼ Interlocked safety doors, automatic inner door, H₂O+O₂ purification unit and analysers.
- ▼ 60m³/h pumping unit with primary pump and a Roots pumping system.

LASER CUTTING

- ▼ Cutting of fuel rods components for the nuclear industry with built-in laser machine.
- ▼ Glove box operating in negative pressure under controlled atmosphere. Double HEPA filtration, automatic pressure regulation and oxygen safety threshold.
- ▼ Working space offering a transfer/preparation area and a double-sided glove box for cutting.
- ▼ Protection of operators: laser security with anti-radiation filtration panels, handling gloves with safety gates and light curtains, vacuum chambers and interlocked doors, Jacomex VMS63 safety valve.
- ▼ Full integration of the laser cutting machine with remote controls, reinforced frame, anti-vibration marble.

ADDITIVE MANUFACTURING

- ▼ Surface functionalization and parts repair by laser cladding technique. Metal deposition of super alloys
- ▼ Glove box **G[mega] 45m³**
- ▼ Controlled atmosphere with an H₂O-O₂ four-lines purification unit P[sys]-IV-S
- ▼ Two vacuum chambers with transfer rails for the loading of middle-sized parts. Access door for the loading of large parts. Ø400 mm transfer chamber for tooling transfer
- ▼ Six-axes robot with reloading head for powder projection/fusion

Our modular and large-dimensional glove boxes are perfectly fitted to your industrial processes within traditional and cutting-edge fields: 3D Printing and Additive Manufacturing, Aeronautics, Laser and Titanium welding, Medical, Food-industry...





Relying on a 75 years old experience in the nuclear field, JACOMEX is the ideal partner when dealing with applications requiring a reinforced protection for the manipulators and the environment. Security level and design are largely customizable

INDUSTRIAL PROCESS - R&D

- ▼ Glove box under controlled atmosphere with integration of a 3D printer which has allowed the 1st worldwide production of 3D printed objects in uranium-molybdenum and uranium-silicon in the Research and Innovation Laboratories of Framatome-CERCA.
- ▼ Other glove boxes with similar design have been supplied in the same laboratories enabling the integration of complex machines and processes: crushing, grinding, screening, induction furnace, weighing, laser cutting, tensile testing ...
- ▼ Double HEPA filtration, vacuum chamber with interlocked doors, RTP systems, external remote machine controls, alarms and O₂ level control (% - ppm).

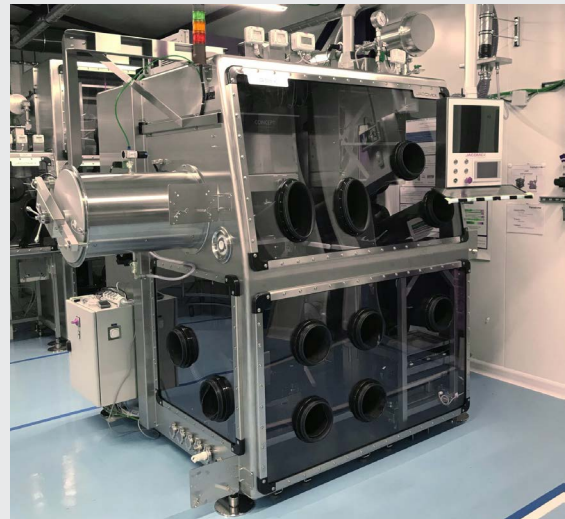

EUROPEAN NUCLEAR WORKSITES

- ▼ Glove box for the European Spallation Source (ESS) Sweden.
- ▼ Containment facility for component transfer operations from and into a shielded hot cell.
- ▼ Double HEPA filtration, ventilated transfer chamber, hatches and bag rings, handling tools and winch for moving heavy materials.

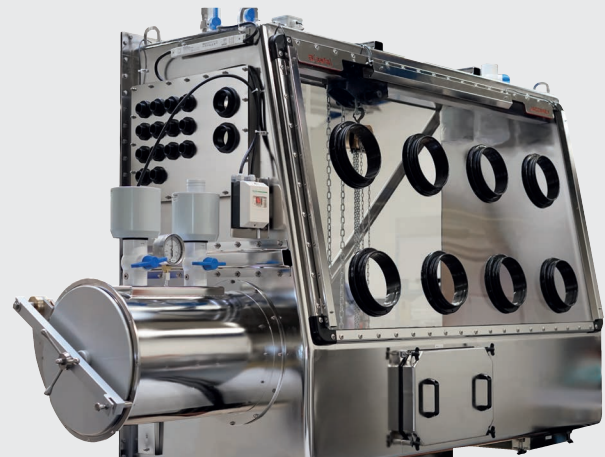

INTERNATIONAL SAFEGUARDS

- ▼ Lines of gloveboxes at the new IAEA's Safeguards Analytical Laboratories
- ▼ Rounded corners.
- ▼ Transfer airlocks, RTP and container flanges.
- ▼ Alarm management and fire safety.
- ▼ Particles and acid fumes trapping.
- ▼ Automatic negative-pressure regulation and safety flow rate of 200m³/h.





DECONTAMINATION / DECOMMISSIONING

- ▼ Glove boxes for the maintenance and decontamination of parts on a radioactive waste storage site.
- ▼ Installations with Jacomex safety control valves operating under air.
- ▼ Options and equipment on request:
 - Transfer airlock and large diameter bag rings.
 - Safety lift-up panel.
 - Closed loop vacuum cleaner with safe waste management.

NEW GENERATION REACTORS

- ▼ Glove boxes for experiments and corrosion studies in nuclear environment under purified inert atmosphere.
- ▼ Double HEPA filtration on a sealed hermetic gas circuit.
- ▼ Safety valves operating under nitrogen.
- ▼ Pollution free transfers with double filtration.
- ▼ Large capacity H₂O and O₂ purification unit with analysers, flow control, alarms.
- ▼ Processes at 5-10ppm H₂O and O₂ in negative pressure.

PROCESSES - MACHINE INTEGRATION

- ▼ Glove box with Thin Film Deposition system for substrate development in nuclear environment.
- ▼ Double HEPA filtration under air.
- ▼ Transfers through airlock and bag rings.
- ▼ Integration of an ultra-high vacuum deposition chamber with crucibles, evaporation sources and control cabinet.
- ▼ Rely on our expertise and our own engineering department to make any integration possible with the original process characteristics (furnace, evaporator, ICP-MS mass spectrometer, etc.).

Custom-made glove boxes for the nuclear sector developed by our own design office. Numerous technical solutions allow to comply perfectly with the required use and the environmental safety constraints.

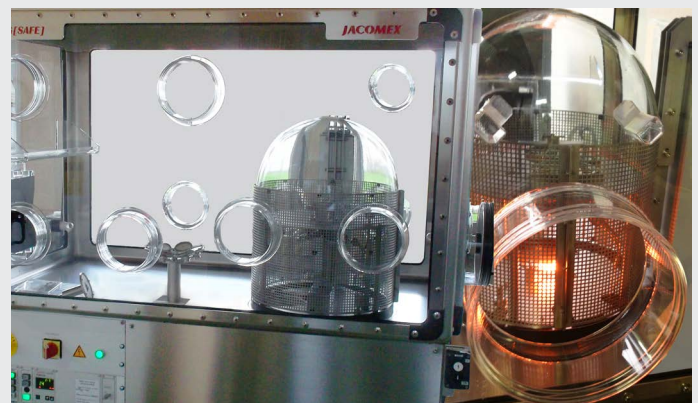



Our various departments (sales, design office, engineering, quality, technical and R&D, assembly, testing, service) are hosted in the same facility, ensuring flexibility, responsiveness and performance.

PHARMA / API AND HP-API

- ▼ Isolator functioning in negative pressure under air or nitrogen with dual HEPA filtration, BIBO, pressure, temperature and humidity controls, filter clogging indicators, traceability by recorder.
- ▼ Transfer systems: bag-in/bag-out ports, EZI-dock, airlock with integrated oven and automatic safety doors.
- ▼ AISI US316L electropolished stainless steel finish: isolator, transfer systems and easily cleanable doors.
- ▼ Operator protection with guaranteed safety flow rate of 200m³/h in the event of containment failure.



PHARMA / PROCESSES

- ▼ AISI US316L stainless steel pharmaceutical isolator with two built-in freeze-dryers. Automatic airlock with interlocked doors. Safety lift-up front panel in mineral glass with inflatable gasket.
- ▼ AISI US316L electropolished stainless steel finish, isolator, transfer systems and easily cleanable doors.
- ▼ Control / Air Conditioning and humidity regulation < 0.1% RH
- ▼ Easily cleanable and bio-decontaminable work space using hydrogen peroxide vapour.



PHARMA / ANAEROBIC ENVIRONMENT

- ▼ AISI US316L stainless steel cell bank isolator under ultra-pure controlled atmosphere (probiome science).
- ▼ Safe vacuum chamber with automatic transparent mineral glass doors.
- ▼ Particle control as per ISO 14644-1 with laminar flow.
- ▼ Gas purification and solvent trapping unit:
- ▼ O₂ < 1ppm, H₂O < 0.1%.
- ▼ Easily cleanable and bio-decontaminable work space using hydrogen peroxide vapour.





PHARMA - MEDICAL / LAMINAR FLOW

- ▼ A laminar flow system to achieve a severe environment with a controlled particle concentration can be installed on our range of isolators operating :
 - in positive or negative pressure
 - under air or under controlled purified atmosphere.
- ▼ ISO 5 classification as per 14644-1 (certified when no handling) on request.
- ▼ WIP / CIP cleaning solutions.

MEDICAL / BIOLOGY

- ▼ Climatic isolators facility for experiments and research in molecular cell biology.
- ▼ Controlled atmosphere with negative pressure regulation.
- ▼ Stand-alone units for temperature (°C) and humidity (%RH) control. Parameters configurable on HMI/Touch panel.
- ▼ CO₂ % control and O₂ removal (0.0001% <1 ppm).
- ▼ Can be manufactured in Corian or US AISI 304/316L stainless steel.
- ▼ Specific equipment: binoculars - lifting panels - connected interlocked airlock chambers.

MEDICAL / IMPLANTS

- ▼ Isolator under controlled atmosphere for the assembly and packaging of medical implants.
- ▼ Safe environment free of carbon particles, hydrocarbons, pollutants and microbial contamination.
- ▼ Particle filtration, solvent and acid trapping.
- ▼ O₂ control <1%.
- ▼ Monobloc stainless steel enclosure, rounded corners, roughness <0.8µm, inner Teflon coating.
- ▼ Special air-lock for clean transfer of medical devices between the clean room and the controlled area.

GEP-GMP compliant and IQ-OQ verified isolators (FAT/SAT).
Specific documented projects on request (CFR21 part.11, GAMP5, HDS, FS, RTM...)

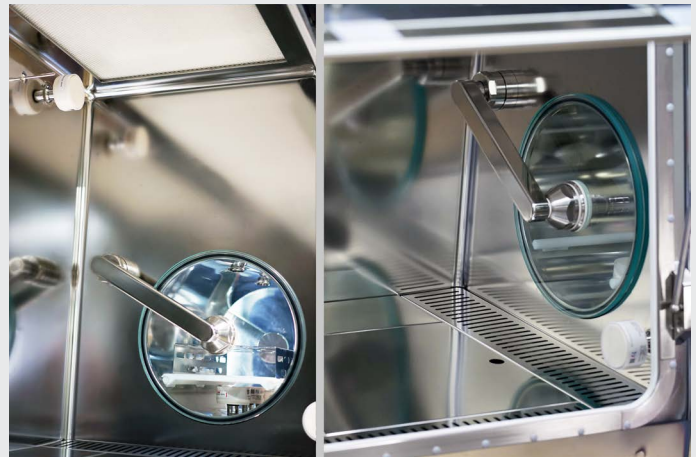



THEY TRUST US

Expertise, know-how, human and technical skills, overall management of your projects, service department...
Our major asset, YOUR GUARANTEES



- ▼ Chemistry
- ▼ Physics
- ▼ Material Science
- ▼ Energy
- ▼ Organic Electronics
- ▼ Additive Manufacturing
- ▼ Aeronautics
- ▼ Nuclear
- ▼ Pharma
- ▼ Medical
- ▼ Biology
- ▼ Geosciences

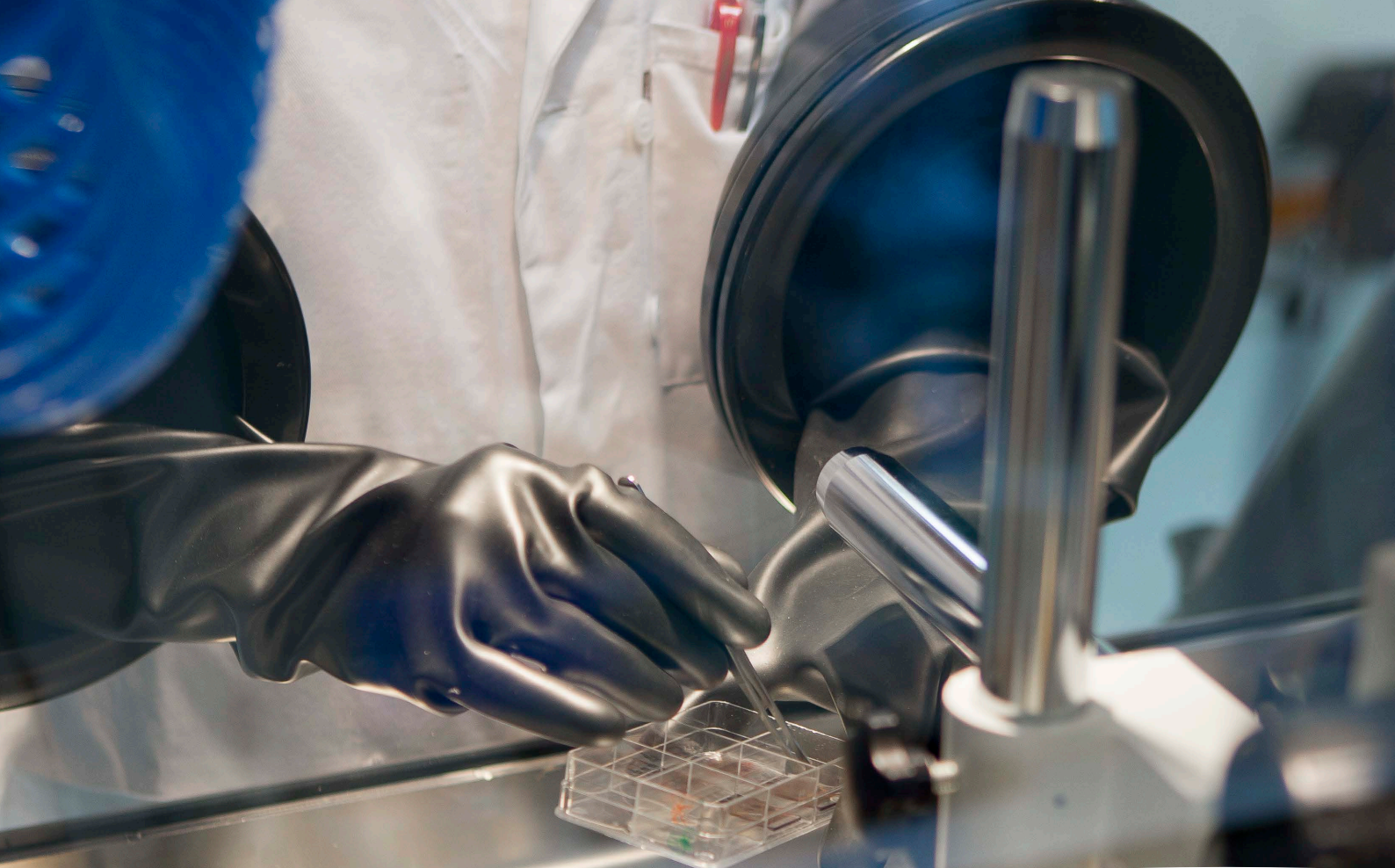

JACOMEX
pure safety

184 avenue du Bicentenaire - Zone Les Prés Seigneurs - 01120 DAGNEUX - FRANCE
+33 (0) 472 251 900 - contact@jacomex.com - sav@jacomex.com

www.jacomex.com