

Series 475

Series 475 Convectron®
Vacuum Measurement Controller



Instruction Manual

Instruction manual part number 475101

Revision 1 - September 2017

Series 475

Series 475 Convectron® Vacuum Measurement Controller

This Instruction Manual is for use with all Granville-Phillips Series 475 Vacuum Measurement Controllers. A list of applicable catalog numbers is provided on the following page.

This product is RoHS compliant.



Customer Service / Technical Support:

MKS Pressure and Vacuum Measurement Solutions

MKS Instruments, Inc.
6450 Dry Creek Parkway
Longmont, Colorado 80503 USA
Tel: 303-652-4400
Fax: 303-652-2844
Email: mks@mksinst.com

MKS Corporate Headquarters

MKS Instruments, Inc.
2 Tech Drive, Suite 201
Andover, MA 01810 USA
Tel: 978-645-5500
Fax: 978-557-5100
Email: mks@mksinst.com

Instruction Manual

Series 475 Convectron Vacuum Measurement Controller

Catalog numbers for Series 475 Convectron Vacuum Measurement Controller with Graphic Display
Panel Mount or Benchtop Mount

Controller:

Panel Mount or Benchtop Mount

475001 - X X - X

Interface:

None
RS-232
RS-485/422



Setpoints:

No setpoints
Two setpoints

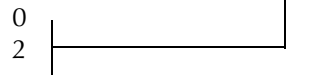

Measurement Units:

Torr
mbar
Pascal

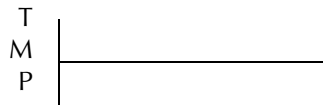

Power Supply:

Universal, CE Compliant

475008 - X

Power Cords:

North American 115 VAC & Japan 100 VAC
North American 240 VAC
Universal Europe 220 VAC
United Kingdom 240 VAC



Convectron Gauges

Gold-Plated Tungsten Sensor

275071 1/8 inch NPT / 1/2 inch compression fitting
275185 1/4 inch VCR-type female fitting
275233 3/8 inch VCO-type male fitting
275282 1/2 inch VCR-type female fitting
275256 1.33 inch (NW16CF) rotatable ConFlat-type flange
275238 2.75 inch (NW35CF) rotatable ConFlat-type flange
275203 NW16KF flange
275196 NW25KF flange
275316 NW40KF flange

Platinum Sensor

275320-PP 1/8 inch NPT, 1/2 inch compression fitting
275320-PQ 1/4 inch VCR-type female fitting
275320-PR 1/2 inch VCR-type female fitting
275320-PF 1.33 inch CF (NW16CF) rotatable ConFlat-type flange
275320-PG 2.75 inch CF (NW35CF) rotatable ConFlat-type flange
275320-PD NW16KF flange
275320-PE NW25KF flange
275320-PK NW40KF flange
275320-PB 15 mm OD tubulation, metric O-ring compression fitting

Table of Contents

Chapter 1	Safety & Introduction	9
1.1	Caution and Warning Statements	9
1.2	Reading and Following Instructions	9
1.3	System Grounding	10
1.4	Explosive Gases	10
1.5	Explosion / Implosion	10
1.6	Overpressure Conditions	10
1.7	Operation	11
1.8	Certification	11
1.9	Warranty	11
1.10	Service Guidelines	11
1.11	Damage Requiring Service	12
1.12	Specifications & Compliance	13
Chapter 2	Installation	15
2.1	System Components	15
2.2	Pre-Installation Considerations	17
2.3	Installation Procedure	18
2.4	Install Pressure Relief Devices	18
2.5	Mount the Controller	18
2.6	Install the Convectron Gauge	20
	Install Vacuum Chamber Fittings	21
	Ground the Convectron Gauge	22
2.7	Connect the Wiring	23
2.8	Connectors	25
2.9	Configure the Relays for the Application	26
2.10	Requirements for Process Control Option	26
Chapter 3	Operation	27
3.1	Preparing for Pressure Measurement	27
3.2	Button Overview	27
3.3	Initial Power Up	27
3.4	Menu Overview	28
	Product Information	29
	Keypad	29
	Diagnose	29
	Calibrate	30
3.5	Configure	31
	Setpoint Parameters	31
	RS-232 Parameters	32
	RS-485/422 Parameters	32
	Analog Output	33
	Pressure Units	34
	Display Options	34
	Gas Species	35
	Pressure Filtering	36
	Restore Configuration	37
	Save Configuration	37
	Gauge Sensor Type	37

	Correction Factor Parameters	38
3.6	Error Codes	39
3.7	Preparing For Convectron Gauge Operation	40
3.8	Convectron Gauge Theory of Operation	40
3.9	Convectron Gauge Sensors	41
3.10	Using Gases Other than N ₂ or Air	41
	Effects on User Calibration	41
	Indicated vs. True Pressure for Gases Other Than N ₂ or Air	42
	Examples	43
3.11	Calibration	51
	Calibration Ranges for Different Gas Species	51
	Vacuum Calibration	51
	Atmosphere Calibration	51
	Convectron Gauge Use Below 10 ⁻³ Torr	52
	NIST Traceable System Calibration	52
3.12	Convectron Gauge Analog Output Signal	53
	Default Analog Output of 0 to 7 V	55
	Optional Analog Output of 1 to 8 V	55
	Optional Nonlinear Analog Output “S Curve”	55
3.13	Analog Output Mode Programming	56
3.14	Process Control Setpoints & RS-232 or RS-485 Interface	56
Chapter 4	Process Control	57
4.1	Process Control Setup	57
4.2	Connecting Process Control Relays	58
4.3	Setpoint Display and Adjustment	58
4.4	Process Control Tips	59
4.5	Process Control Factory Default Settings	59
4.6	Process Control Relay Trip Points	60
Chapter 5	RS-232 Interface	61
5.1	RS-232 Theory of Operation for the 475 Controller	61
5.2	Connecting the RS-232 Computer Interface	61
5.3	RS-232 Handshake	62
5.4	Command-Response Timing	64
5.5	Preparing the RS-232 Computer Interface	64
5.6	RS-232 Command Syntax	65
5.7	RS-232 Troubleshooting	75
	RS-232 Error Messages	75
Chapter 6	RS-485 Interface	77
6.1	RS-485/422 Computer Interface Setup	77
6.2	RS-485/422 Computer Interface Factory Default Settings	77
6.3	RS-485/422 Computer Interface Settings	77
	Baud Rate	77
	Data Format	77
	Address	78
	Bus Type	78
	Transceiver Mode	78
6.4	RS-485/422 Physical Configurations	78
	Connecting the RS-485/422 Computer Interface	80
6.5	Communications Protocol	81
6.6	RS-485/422 Command Syntax	81
6.7	RS-485/422 Response Syntax	81

	Command Descriptions	82
6.8	Command-Response Timing	93
6.9	RS-485 Troubleshooting	94
	RS-485 Error Messages	94
Chapter 7	Diagnostics	95
7.1	Continuous Diagnostics	96
7.2	Diagnostics Requiring User Interaction	96
	Analog Output	96
	Measurement Circuits	96
7.3	Convectron Gauge Simulator	97
	Simulate a Process Operation Prior to Full System Integration	97
	Analog Output Tests	98
	Controller Calibration Verification	98
Chapter 8	Service and Maintenance	99
8.1	Customer Service	99
8.2	Service Guidelines	99
8.3	Damage Requiring Service	100
8.4	Error Codes and Possible Solutions	101
8.5	Convectron Gauge Test Procedure	103
8.6	Cleaning Contaminated Convectron Gauges	103
8.7	Reset to Factory Defaults	104
Index		105

Chapter 1 Safety & Introduction

1.1 Caution and Warning Statements

This manual contains caution and warning statements with which you *must* comply to prevent inaccurate measurement, property damage, or personal injury.

CAUTION

Caution statements alert you to hazards or unsafe practices that could result in minor personal injury or property damage.

Each caution statement explains what you *must* do to prevent or avoid the potential result of the specified hazard or unsafe practice.

WARNING

Warning statements alert you to hazards or unsafe practices that could result in severe personal injury or death due to electrical shock, fire, or explosion.

Each warning statement explains what you *must* do to prevent or avoid the potential result of the specified hazard or unsafe practice.

Each caution or warning statement explains:

1. The specific hazard that you *must* prevent or unsafe practice that you *must* avoid,
2. The potential result of your failure to prevent the specified hazard or avoid the unsafe practice, and
3. What you *must* do to prevent the specified hazardous result.

1.2 Reading and Following Instructions

You must comply with all instructions while you are installing, operating, or maintaining the Controller. Failure to comply with the instructions violates standards of design, manufacture, and intended use of the Controller. Granville-Phillips and Brooks Automation disclaim all liability for the customer's failure to comply with the instructions.

- Read instructions – Read all instructions before installing or operating the Controller.
- Retain instructions – Retain the instructions for future reference.
- Follow instructions – Follow all installation, operating and maintenance instructions.
- Heed warnings and cautions – Adhere to all warnings and caution statements on the Controller and in these instructions.
- Parts and accessories – Install only those replacement parts and accessories that are recommended by Granville-Phillips. Substitution of parts is hazardous.

 **WARNING**

Read these safety notices and warnings before installing, using, or servicing this equipment. If you have any doubts regarding the safe use of this equipment, contact the MKS Customer Service department at the address listed in this user manual.

Each warning statement explains what you *must* do to prevent or avoid the potential result of the specified hazard or unsafe practice.

- 1.3 System Grounding** Ion producing equipment, such as ionization gauges, mass spectrometers, sputtering systems, etc., from many manufacturers may, under some conditions, provide sufficient electrical conduction via a plasma to couple a high voltage electrode potential to the vacuum chamber. If exposed conductive parts of the gauge, Controller, and chamber are not properly grounded, they may attain a potential near that of the high voltage electrode during this coupling. Potential fatal electrical shock could then occur because of the high voltage between these exposed conductors and ground. All components in a vacuum system used with this or any similar high voltage product must be maintained at Earth ground for safe operation. Connect power cords only to properly grounded outlets or sources.
- 1.4 Explosive Gases** Do not use the Series 475 Controller or a Series 275 Convector Gauge in an environment of explosive or combustible gases or gas mixtures. Operation of any electrical instrument in such an environment constitutes a definite safety hazard. Do not use the product to measure the pressure of explosive gases or gas mixtures. The sensor wire of a Convector Gauge normally operates at 125 degrees Centigrade. If a malfunction causes the sensor wire to reach a higher temperature, it could raise the sensor wire temperature to above the ignition point of combustible materials or gases. Danger of explosion or inadvertent venting to atmosphere exists in all vacuum systems which incorporate gas sources or involve processes capable of pressuring the system above safe limits.
- 1.5 Explosion / Implosion** Danger of injury to personnel and damage to equipment exists on all vacuum systems that incorporate gas sources or involve processes capable of pressuring the system above the limits it can safely withstand. For example, danger of explosion in a vacuum system exists during backfilling from pressurized gas cylinders because many vacuum devices such as ionization gauge tubes, glass windows, glass belljars, etc., are not designed to be pressurized.
- 1.6 Overpressure Conditions** Do NOT subject Series 275 Convector Gauges to pressures above 1000 Torr. Install suitable devices that will limit the pressure from external gas sources to the level that the vacuum system can safely withstand. In addition, install suitable pressure relief valves or rupture disks that will release pressure at a level considerably below that pressure which the system can safely withstand.

Suppliers of pressure relief valves and pressure relief disks can be located via an online search, and are listed on ThomasNet.com under “Relief Valves” and “Rupture Discs. **Confirm that these safety devices are properly installed before installing and operating the Convectron Gauge.**

In addition, check that (1) the proper gas cylinders are installed, (2) gas cylinder valve positions are correct on manual systems, and (3) the automation is correct on automated systems.

Using the N₂ calibration to pressurize a vacuum system above 1 Torr with certain other gases can cause dangerously high pressures which can cause explosion of the system. See *Indicated vs. True Pressure for Gases Other Than N₂ or Air* on page 42.

If used improperly, Convectron Gauges can supply misleading pressure indications that can result in dangerous overpressure conditions within the system.

1.7 Operation

It is the installer's responsibility to ensure that the automatic signals provided by the process control module are always used in a safe manner.

Carefully check manual operation of the system and the setpoint programming before switching to automatic operation. Where an equipment malfunction could cause a hazardous situation, always provide for fail-safe operation. As an example, in an automatic backfill operation where a malfunction might cause high internal pressures, provide an appropriate pressure relief device.

1.8 Certification

MKS Instruments, Inc. certifies that this product met its published specifications at the time of shipment from the factory. MKS Instruments further certifies that its calibration measurements are traceable to the National Institute of Standards and Technology to the extent allowed by the Institute's calibration facility. See the CE Declaration of Conformity for the CE tests performed.

1.9 Warranty

MKS Instruments, Inc. provides an eighteen (18) month warranty from the date of shipment for the MKS Series 475 Controllers. The MKS Instruments, Inc. General Terms and Conditions of Sale provides the complete and exclusive warranty for MKS products. This document is located on our web site at www.mksinst.com, or may be obtained by contacting an MKS Customer Service Representative.

1.10 Service Guidelines

Some minor problems are readily corrected on site. If the product requires service, contact the MKS Technical Support Department at 1-303-652-4400 or 1-800-776-6543 for troubleshooting help over the phone.

If the product must be returned to the factory for service, request a Return Material Authorization (RMA) from MKS, which can be completed at <https://www.mksinst.com/service/servicehome.aspx>. Do not return products without first obtaining an RMA. In most cases a hazardous materials disclosure form is required. The MKS Customer Service Representative will advise you if the hazardous materials document is required.

When returning products to MKS, be sure to package the products to prevent shipping damage. Damaged returned products as a result of inadequate packaging is the Buyer's responsibility.

For Customer Service / Technical Support:

MKS Pressure and Vacuum Measurement Solutions

MKS Instruments, Inc.
6450 Dry Creek Parkway
Longmont, Colorado 80503 USA
Tel: 303-652-4400
Fax: 303-652-2844
Email: mks@mksinst.com

MKS Corporate Headquarters

MKS Instruments, Inc.
2 Tech Drive, Suite 201
Andover, MA 01810 USA
Tel: 978-645-5500
Fax: 978-557-5100
Email: mks@mksinst.com.

1.11 Damage Requiring Service

Turn OFF power to the 475 Controller and refer servicing to qualified service personnel under the following conditions:

- If any liquid has been spilled onto, or objects have fallen into the Controller.
- If a circuit board is faulty.
- If the Convectron Gauge sensing wire is open or the gauge is contaminated.
- If the Controller has been exposed to moisture.
- If the Controller does not operate normally even if you follow the operating instructions. Adjust only those controls that are explained in this instruction manual. Improper adjustment of other controls may result in damage and will often require extensive work by a qualified technician to restore the Controller to its normal operation.
- If the Controller has been dropped or the enclosure has been damaged.
- If the Controller exhibits a distinct change in performance.

1.12 Specifications & Compliance

Table 1-1 Specifications & Compliance for the Series 475 Controller and 275 Convectron Gauge

Parameter	Specification
Measurement Range for N ₂ / Air ^{1,2}	See notes 1 and 2, below
Torr	1x10 ⁻⁴ to 999 Torr
mbar	1x10 ⁻⁴ to 1333 mbar
pascal	1x10 ⁻² to 133.3 kpa
Resolution	1x10 ⁻⁴ Torr, 1x10 ⁻⁴ mbar, 1x10 ⁻² Pascal
Display	Vacuum Fluorescent
Update rate	Every 0.5 sec.
Input power ³	12 to 24 Vdc, 6 W continuous (Inrush <1.4A for <7 msec) (see note 3, below)
Weight	720 gr. (25 oz.)
Operating environment	0 °C to 40 °C ambient, indoor use only, ordinary protection from moisture, maximum altitude 3000 meters
Operating conditions	Suitable for continuous operation, category 1 for insulation overvoltage, pollution degree 2, Class 1
Non-operating temperature	-40 °C to 85 °C
Compliance	
EMC	EN61326-1
Safety	EN61010-1
IP rating	IP20
Environmental	RoHS compliant
Setpoint relays (Optional)	(2) single-pole, double-throw (SPDT) (Limit overvoltage to <2.4kv)
Contact rating	5 A @ 250 VAC resistive load
Range	1x10 ⁻⁴ to 1000 Torr, 0.1 to 1333 mbar, 0.01 to 133.3 kPa
Resolution	1 significant digit in the 10 ⁻⁴ range 2 significant digits in the 10 ⁻³ range 3 significant digits in the 10 ⁻² range and above
Communication Interface (Optional)	
RS-232	
Data format	ASCII, software selectable: "8 bits, no parity, 1 stop bit "7 bits, even parity, 1 stop bit "7 bits, odd parity, 1 stop bit selectable hardware handshake
Baud rate	Software selectable, 1200, 2400, 4800, 9600, 14400, 19200, 28800, 38400
Hardware Handshake	RTS / CTS
RS-485	
Data format	ASCII, software selectable: "8 bits, no parity, 1 stop bit "7 bits, even parity, 1 stop bit "7 bits, odd parity, 1 stop bit
Baud rate	Software selectable, 1200, 2400, 4800, 9600, 14400, 19200, 28800, 38400
Bus type	Software selectable: two-wire or four-wire configurations
Convectron Gauge	
Sensor material	Gold-plated tungsten, or platinum

Table 1-1 Specifications & Compliance for the Series 475 Controller and 275 Convectron Gauge

Parameter	Specification
Other materials exposed to gas	304 stainless steel, borosilicate glass, Kovar, alumina, NiFe alloy, polyimide
Internal volume	40 cm ³ (2.5 in. ³)
Weight	85 gm (3 oz.)
Mounting orientation	Horizontal preferred
Gauge operating temperature	0 °C to 50 °C ambient
Gauge bakeout temperature	150 °C maximum, non-operating, cable disconnected
Cable bakeout temperature	105 °C maximum

1. Measurements will change with different gases and mixtures. Correction parameters must be used for gases other than N₂ or Air.
2. Do NOT use Convectron Gauges with flammable or explosive gases. See Section 1.4.
3. The 24 Vdc input power must be supplied from a power supply certified to IEC Standard with a safety extra low voltage certified output.

Figure 1-1 475 Convectron Gauge Controller Dimensions

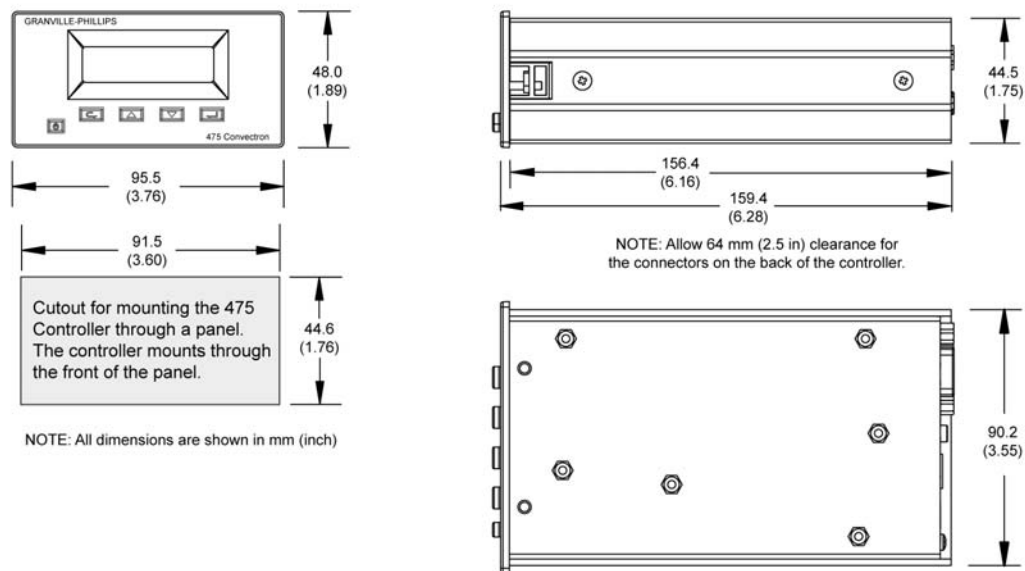
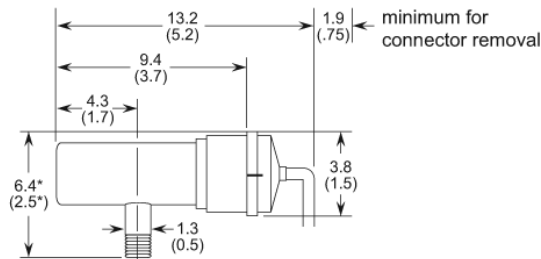

Figure 1-2 Series 275 Convectron Gauge Dimensions



Dimensions are in cm (inch)

* 1/8 NPT, 1/2 inch quick connect, or welded fitting

2.1 System Components

Figure 2-1 and Figure 2-2 illustrate all available options and system capabilities, including Controllers with process control and RS-232 or RS-485 computer interface options.

Figure 2-1 Series 475 Convectron Controller Front and Rear Panels

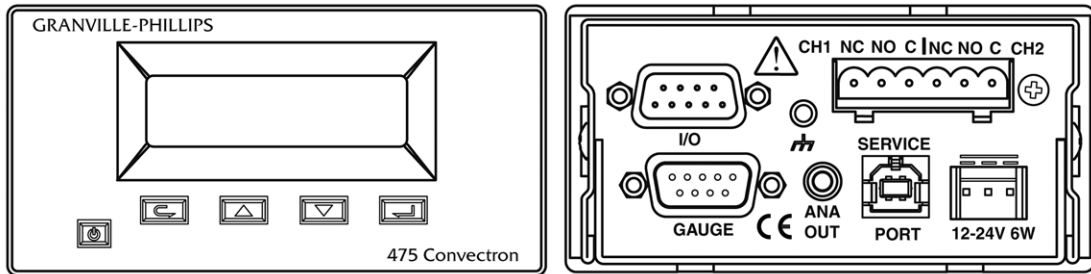

Figure 2-2 Convectron Vacuum Measurement System Components

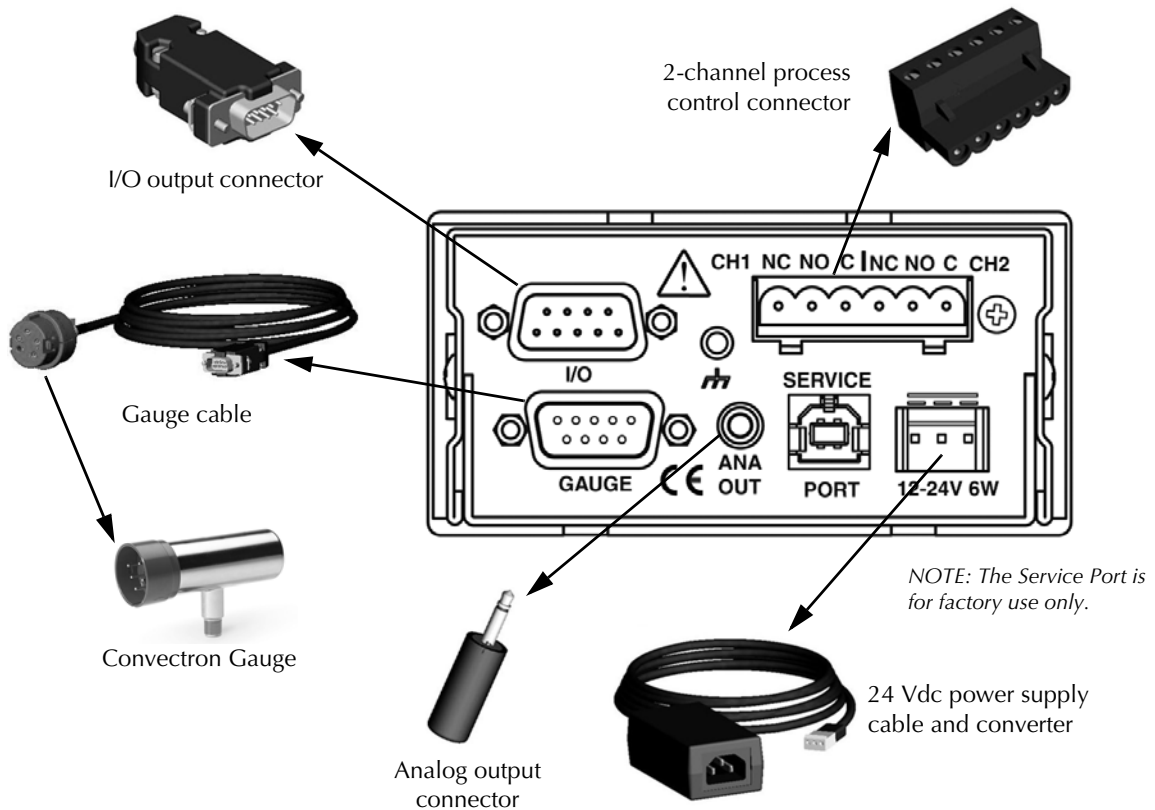

Table 2-1 475 Controller Factory Defaults

Setting	Range or Selection	Factory Default Setting
Units of Measure	Torr, mbar, pascal	Torr, mbar, or pascal as selected when the Controller was purchased.
Gas Species	N ₂ , Ar, O ₂ , He, CO ₂ , FS, CF	N ₂
Correction Factor	0.1 to 1.5	None
Correction Factor Maximum Pressure	1E-3 Torr to 999 Torr	999 Torr
Front Panel Display		
• Brightness	1, 2, or 3	3 (Bright)
• Setpoints displayed	Yes, No	No
Gauge Sensor	Gold-Plated Tungsten, Platinum	Gold-Plated Tungsten
SetPoints/Outputs		
• SP1 Pressure	1E-4 Torr to 1000 Torr	1.00E-4
• SP2 Pressure	1E-4 Torr to 1000 Torr	1.00E-4
• SP1 Hysteresis	5 to 1000 percent	10
• SP2 Hysteresis	5 to 1000 percent	10
• SP1 Polarity	Normal, Reverse	Normal
• SP2 Polarity	Normal, Reverse	Normal
• SP1 Enable	Disable, Enable	Disable
• SP2 Enable	Disable, Enable	Disable
• Analog Out Mode	Log 0-7V, Log 1-8V, S-curve	Log 0 V-7 V
• Analog Out Offset	0.0V to 5.0V	0V
Low-Pass Filter (LPF)	Disable, Enable	Enable
Pressure Response Delay (ms)	0 to 200 ms	0 ms
RS-232		
• Baud Rate	Baud Rate: 1200, 2400, 4800, 9600, 14400, 19200, 28800, 38400	19200 baud
• Data Format	Bits: <ul style="list-style-type: none"> • 8N1 (8 data bits, No parity, 1 stop bit) • 7E1 (7 data bits, Even parity, 1 stop bit) • 7O1 (7 data bits, Odd parity, 1 stop bit) 	8 data bits, No parity, 1 stop bit

Table 2-1 475 Controller Factory Defaults

Setting	Range or Selection	Factory Default Setting
• Hardware Handshake	RTS / CTS or None	None
RS-485		
• Baud Rate	Baud Rate: 1200, 2400, 4800, 9600, 14400, 19200, 28800, 38400	19200 baud
• Data Format	Bits: <ul style="list-style-type: none"> • 8N1 (8 data bits, No parity, 1 stop bit) • 7E1 (7 data bits, Even parity, 1 stop bit) • 7O1 (7 data bits, Odd parity, 1 stop bit) 	8 data bits, No parity, 1 stop bit
• Bus Type	Two-wire or four-wire	Four-wire
• Transceiver Mode	Fast or Slow	Fast

2.2 Pre-Installation Considerations

This chapter guides you through the basic setup procedures for the 475 Controller, including mounting the Controller, installing a Convectron Gauge, connecting vacuum chamber fittings, and connecting wiring.

If your application requires different settings than the factory defaults listed in Table 2-1, see Chapters 3, 4, and 5 for instructions on changing the settings. You can reconfigure options before or after completing the basic setup procedures described in this chapter.

WARNING

Installing, removing, or replacing the 475 Controller in a high-voltage environment can cause an electrical discharge through a gas or plasma, resulting in property damage or personal injury due to electrical shock or fire.

Vent the vacuum chamber to atmospheric pressure and shut OFF power to the Controller before you install, remove, or replace the Controller.

WARNING

Exposing the Controller to moisture can cause fire or electrical shock resulting in product damage or personal injury.

To avoid exposing the Controller to moisture, install the Controller in an indoor environment. Do not install the Controller in any outdoor environment. Do not spill any liquid onto the Controller.

- 2.3 Installation Procedure** The Controller installation procedure includes the following steps:
1. Install the appropriate pressure relief devices in the vacuum system.
 2. Establish the desired location and orientation for the Series 475 Controller.
 3. Install the Convectron Gauge that connects to the Controller.
 4. Assemble and connect the Controller wiring.
 5. Adjust the process control relays for the process pressures that will be used.

- 2.4 Install Pressure Relief Devices** Before you install the Controller, install appropriate pressure relief devices in the vacuum system.
- Granville-Phillips does not supply pressure relief valves or rupture disks. Suppliers of pressure relief valves and pressure relief disks can be located via an on-line search, and are listed on ThomasNet.com under "Relief Valves" and "Rupture Discs. **Confirm that these safety devices are properly installed before installing and operating the product.**

 CAUTION	
<p>Operating the Controller above 1000 Torr (1333 mbar, 133 kPa) true pressure could cause pressure measurement error or product failure.</p> <p>To avoid measurement error or product failure due to overpressurization, install pressure relief valves or rupture disks in the system if pressure exceeds 1000 Torr (1333 mbar, 133 kPa).</p>	

- 2.5 Mount the Controller** To locate and orient the Controller, refer to Figure 2-3 and follow the instructions below.
- For greatest accuracy and repeatability, locate the Controller in a stable, room-temperature environment. Ambient temperature should never exceed 40 °C (104 °F) operating, non-condensing, or 85 °C (185 °F) non-operating.
 - Provide adequate ventilation for the Controller to dissipate 6 Watts.
 - Locate the Controller away from internal and external heat sources and in an area where ambient temperature remains reasonably constant.
 - Do not locate the Controller where it will be exposed to corrosive gases such as mercury vapor or fluorine.
- See *Install the Convectron Gauge* on page 20 for Convectron Gauge installation instructions.

Figure 2-3 Controller Dimensions

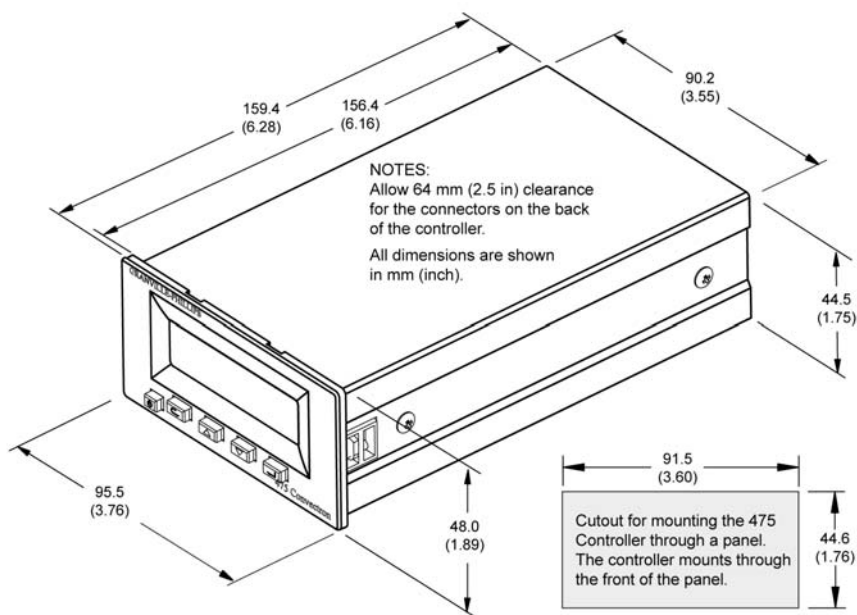

The Controller may be free-standing or panel-mounted. For free standing (benchtop) use, install the provided self-adhesive rubber feet on the bottom of the Controller.

To use the Controller in a free-standing (benchtop) configuration:

1. Apply the four provided adhesive rubber mount feet on the bottom of the Controller.

Figure 2-4 Mount Feet on the Bottom of the Controller

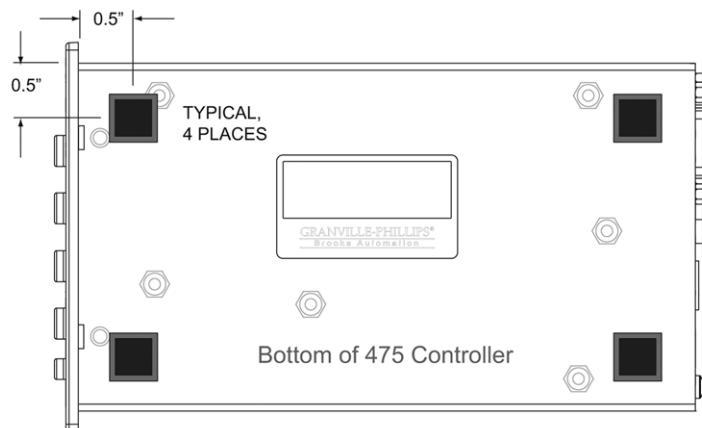

To mount the Controller in a panel, refer to Figure 2-5 and Figure 2-6, and follow these steps:

- Panel opening dimensions are 91.5 mm x 44.6 mm (3.60 inches x 1.76 inch).
- Panel thickness is 3 mm (0.12 inch).
- Provide a minimum of 64 mm (2.5 inch) clearance behind the Controller to allow for cables.

1. Prepare the panel opening per the dimensions listed on Figure 2-3 and the bullet points listed above.
2. Remove the Front Panel (bezel) as shown in Figure 2-5. Hold the Controller in your hands and use your thumbs to push on the bezel. Push the bottom of the bezel loose, then the top.

Figure 2-5 Remove the Front Panel (bezel)

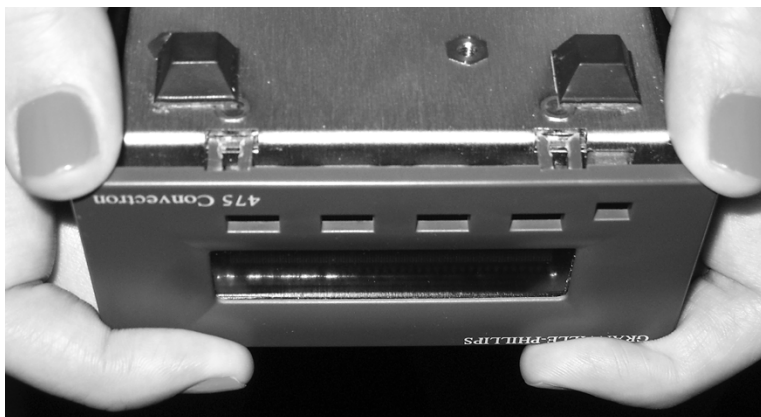

3. Insert the Controller through the front of the panel.

Figure 2-6 Pawl Screw Used to Secure Controller to Panel

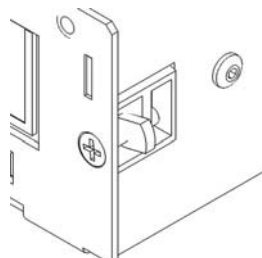

4. Use a Phillips head screwdriver to rotate the Pawl Screw to lock the Controller to the panel. See Figure 2-6.
5. Replace the bezel by aligning it with the keys and push the top and the bottom of the bezel to snap it into place.

2.6 Install the Convectron Gauge

To install Convectron Gauges, refer to Figure 2-7 and follow the instructions below.

- Orient the Convectron Gauge to prevent condensation of process vapors on the internal surfaces through line-of-sight access to its interior. If vapor condensation is likely, orient the port downward to help liquids drain out.
- For proper operation above about 1 Torr, install Convectron Gauges with the gauge axis horizontal.

Figure 2-7 Convectron Gauge Installation

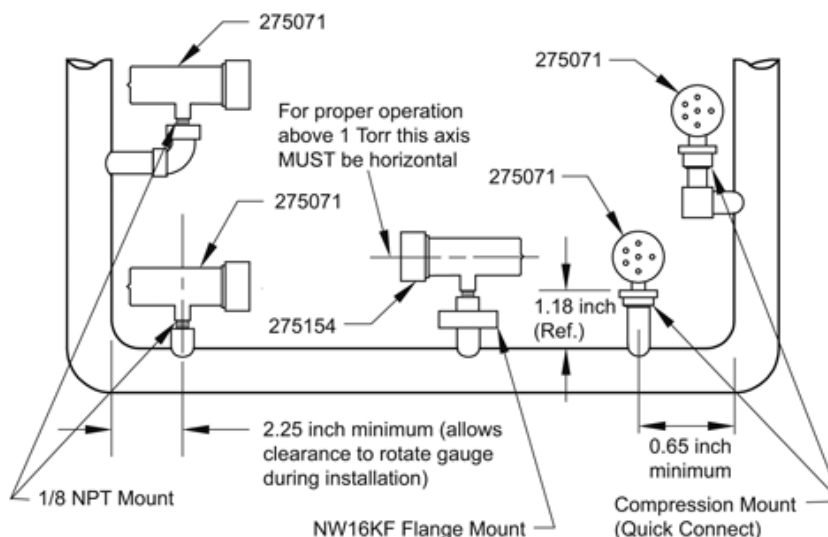

- Do not locate the Convectron Gauge near the pump, where gauge pressure might be lower than normal vacuum pressure.
- Do not locate the gauge near a gas inlet or other source of contamination, where inflow of gas or particulates causes atmospheric pressure to be higher than system atmosphere.
- Do not locate the gauge where it will be subjected to vibration, which causes convection cooling, resulting in inaccurate high pressure readings.
- Do not locate the gauge where it will be subjected to extreme temperature fluctuations. For greatest accuracy and repeatability the gauge should be located in a stable room temperature environment.

Install Vacuum Chamber Fittings

Do not use a compression mount/quick connect fitting for positive pressure applications. The gauge may be forcefully ejected. The gauge port fits a standard 1/2-inch compression/quick connect mounting such as an Ultra-Torr® fitting.

⚠ WARNING

Failure to install appropriate pressure relief devices for high-pressure applications can cause product damage or personal injury.

For automatic backfilling and other applications in which malfunction or normal process conditions can cause high pressures to occur, install appropriate pressure relief devices.

1/8 NPT Pipe Thread



- The 1/8 NPT pipe thread accommodates a standard 1/8 NPT female fitting.
1. Wrap the threads of the port to the vacuum chamber with thread sealant tape.
 2. Tighten the gauge just enough to achieve a seal. Do NOT over tighten.

VCR Type Fitting

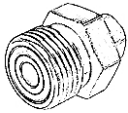

1. Remove the plastic or metal bead protector cap from the fitting.
2. If a gasket is used, place the gasket into the female nut.
3. Assemble the components and tighten them to finger-tight.
4. While holding a back-up wrench stationary, tighten the female nut 1/8 turn past finger-tight on 316 stainless steel or nickel gaskets, or 1/4 turn past finger-tight on copper or aluminum gaskets.

KF Flange



The KF mounting system requires O-rings and centering rings between mating flanges.

1. Tighten the clamp wing nut to compress the mating flanges together.
2. Seal the O-ring.

ConFlat Flange

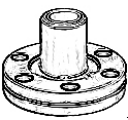

To minimize the possibility of leaks with ConFlat flanges, use high strength stainless steel bolts and a new, clean OFHC copper gasket. Avoid scratching the seal surfaces. To avoid contamination, install metal gaskets.

1. Finger tighten all bolts.
2. Use a wrench to continue tightening 1/8 turn at a time in criss-cross order (1, 4, 2, 5, 3, 6) until the flange faces make contact. Further tighten each bolt about 1/16 turn.

Ground the Convector Gauge

- If the Convector Gauge has a VCR type fitting or ConFlat flange, it will be properly grounded via the vacuum chamber connection.
- If the Convector Gauge has a KF flange or an NPT fitting, use a length of #12 AWG braided copper wire which connects to the Convector Gauge and to the vacuum chamber ground connection. See Figure 3.

⚠ WARNING

Improper grounding could cause product failure or personal injury.

- Follow ground network requirements for the facility.
- Maintain all exposed conductors at earth ground.
- Make sure the vacuum port to which the gauge is mounted is properly grounded.

Figure 2-8 Convector Gauge to Vacuum Chamber Ground Connection



2.7 Connect the Wiring

The 475 Controller has connectors for Convectron Gauge cable, RS-232, RS-485/422, setpoints, analog output cable, and power supply wiring, as illustrated in Figure 2-9 (shown with the optional RS-232 and setpoint connectors).

Figure 2-9 Convectron Gauge, Output, and Power and Ground Connections

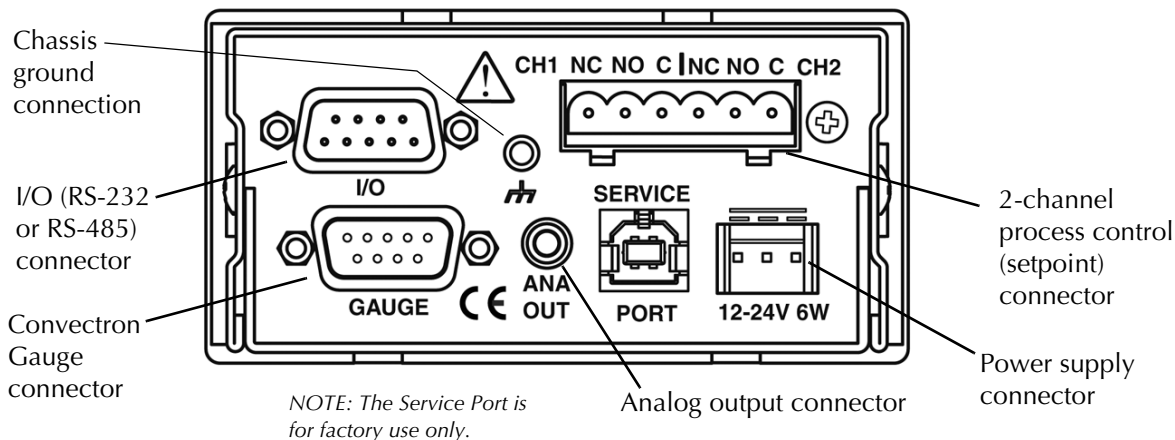

- Ground the 475 Controller either of the two ways listed below, but not both. Connecting the chassis ground through both the power supply connector and the chassis ground connection on the rear of the 475 Controller will create a ground loop.
 1. **Power Supply Ground Connection (preferred):**
If using a universal power supply provided by MKS (p/n 475008) ensure that the receptacle that the power supply is plugged into is properly connected to an Earth ground. If using another power supply, ensure pin 3 of the power supply connector is connected to Earth ground of the power supply.
The 3-pin power connector on the rear of the 475 Controller is illustrated in Figure 2-12.
 2. **Chassis Ground Connection on the rear of the 475 Controller:**
Connect a #12 AWG ground wire to the chassis ground connection on the rear of the Controller and to a known Earth ground. Do NOT connect a ground wire from the Controller directly to the vacuum chamber or system ground.

Figure 2-10 Grounding Scheme for the 475 Controller

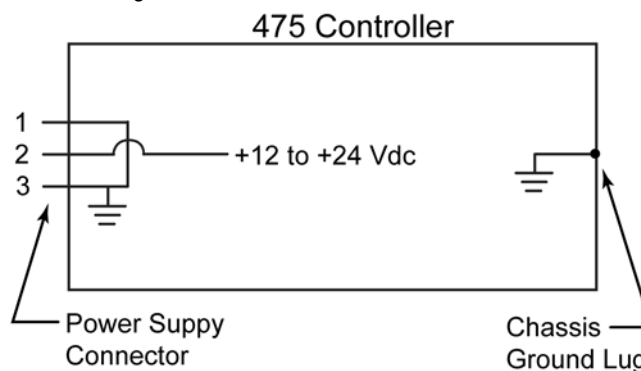

⚠ WARNING

Improper grounding can cause product damage or personal injury.

Follow ground network requirements for the facility.

- Maintain all exposed conductors at earth ground.
- Connect the power cord to a properly grounded outlet.
- Make sure the vacuum port to which the gauge is mounted is properly grounded.
- Connect the Convectron Gauge envelope to a facility ground or shield the envelope. If necessary, use a ground lug on the flange bolt. Ground the gauge envelope by using a metal hose clamp on the gauge connected by a #12 AWG (minimum size) copper wire to the grounded vacuum chamber.

- Connect the Convectron Gauge cable between the gauge and the Controller. See Figure 2-9.
- Connect the power supply by inserting the power cord with the locking tab up. See Figure 2-11.

NOTE: The 475 Controller is internally limited to 28 Vdc maximum and 1.4 A. Do not connect the input to high voltage.

Power supply wiring depends on the power supply voltage and the type of mounting. There are two ways to supply power to the 475 Controller:

1. Use a CE-compliant power supply: 90 to 250 VAC input, 24 Vdc output, with connection plugs to accommodate the local AC plug type (catalog number 475008-1 through -4 -- See page 4 of this Instruction Manual).
2. User supplied power to the Controller using a wire adapter and plug to connect to a 12 to 24 Vdc supply voltage (Granville-Phillips part number 167820). If you use the wire adapter, the wires to be connected to the user supplied power are marked on the end of the cable:

Outside: Supply ground for 12 to 24 Vdc power supply

Center: +12 to 24 Vdc power < 0.5 A @ 12 V (i.e. < 6 Watts) continuous (Inrush limited to < 1.4 A for < 7 msec)

Colored End: Safety chassis ground.

Both options accommodate the same orientation and connection plug. The locking tab mechanism is on the top side of the connector when you plug it into the rear panel. See Figure 2-11.

Figure 2-11 Locking Tab for Power Supply Cord

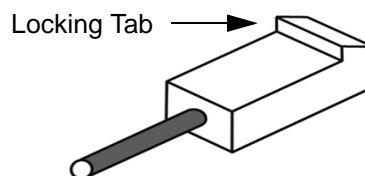

2.8 Connectors

The following figures illustrate the connectors on the back of the 475 Controller.

Figure 2-12 3-Pin Power Supply Connector

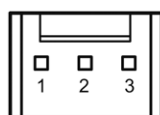

12-24V 6W

- Pin #
- 1 Supply Ground
 - 2 Supply Power: 12 Vdc to 24 Vdc
 - 3 Chassis Ground

NOTE: Pin 1 and Pin 3 are electrically connected internally.

Figure 2-13 I/O (RS-485/RS-422) 9-Pin Connector (pins)

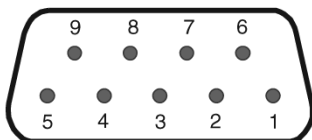

RS-485/422 Connector Pin Assignments, 4-wire

Pin #	Signal	Direction
4	+ TX	To computer
3	Ground	N/A
5	- TX	To computer
8	+ RX	To 475
9	- RX	To 475

RS-485/422 Connector Pin Assignments, 2-wire

Pin #	Signal	Direction
3	Ground	N/A
8	+ RX & +TX	To 475 / To computer
9	- RX & -TX	To 475 / To computer

Figure 2-14 I/O (RS-232) 9-Pin Connector (pins)

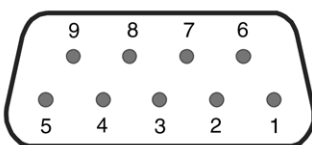

Pin #	Signal	Pin #	Signal
1	Not Used	6	Data Set Ready (DSR)
2	Transmit (TXD)	7	Clear To Send (CTS)
3	Receive (RXD)	8	Request To Send (RTS)
4	Not Used	9	Not Used
5	Signal Ground		

Figure 2-15 Convectron Gauge 9-Pin Connector (sockets)

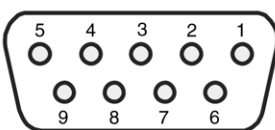

Pin #	Signal	Pin #	Signal
1	Simulated Bridge +	6	Gauge Null Point -
2	Chassis Ground	7	Gauge Bridge +
3	Gauge Bridge -	8	Gauge Bridge Reference +
4	Gauge Bridge Reference -	9	Simulated Bridge -
5	Gauge Null Point +		

Figure 2-16 2-Channel Process Control Connector (pins)

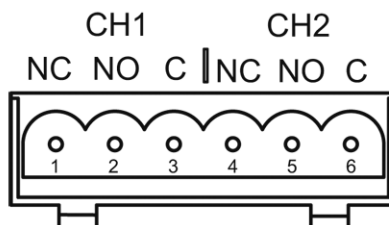

- Pin #
- 1 Channel 1 Normally Closed
 - 2 Channel 1 Normally Open
 - 3 Channel 1 Common
 - 4 Channel 2 Normally Closed
 - 5 Channel 2 Normally Open
 - 6 Channel 2 Common

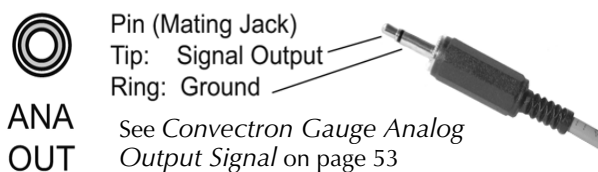
Figure 2-17 Analog Output Connector (socket)

2.9 Configure the Relays for the Application

- To configure the setpoint relays for the process control option, see page 57.
- To configure the setpoint relays using the RS-232 option, see *PCE Relays* on page 69.
- To configure the setpoint relays using the RS-485 option, see *PCE Relays* on page 87.

If the Controller will measure the pressure of a gas other than N₂ or air, you *must* adjust relay setpoints for the process gas. The true pressure of a gas other than N₂ or air may be substantially different from the pressure that the output indicates. For example, outputs might indicate a pressure of 10 Torr (13.3 mbar, 1.33 kPa) for argon, although the true pressure of the argon is 250 Torr (333 mbar, 33.3 kPa). Such a substantial difference between indicated pressure and true pressure can cause over pressurization resulting in an explosion. See *Using Gases Other than N₂ or Air* on page 41 and *Gas Species* on page 35.

WARNING

Failure to use accurate pressure conversion data for N₂ or air to other gases can cause an explosion due to over-pressurization.

If the Controller will measure any gas other than N₂ or air, before putting the Controller into operation, adjust relays for the process gas that will be used.

2.10 Requirements for Process Control Option

If you are using the process control option, you must prepare for process control operation before turning ON the Controller. See *Chapter 4* for complete process control setup instructions.

CAUTION

Failure to check system setup configuration before switching to automatic operation can cause errors.

3.1 Preparing for Pressure Measurement

Before you prepare for process measurement, make sure:

- The Controller was properly set up and installed per the instructions in *Chapter 2*.
- The gas in your vacuum system is air or N₂. If you are using other gases you must follow the instructions in *Using Gases Other than N₂ or Air* on page 41 and *Indicated vs. True Pressure for Gases Other Than N₂ or Air* on page 42.
- You are reasonably familiar with the general theory of operation of thermal conductivity gauges. See *Convectron Gauge Theory of Operation* on page 40.

Figure 3-1 Series 475 Convectron Gauge Controller Front Panel

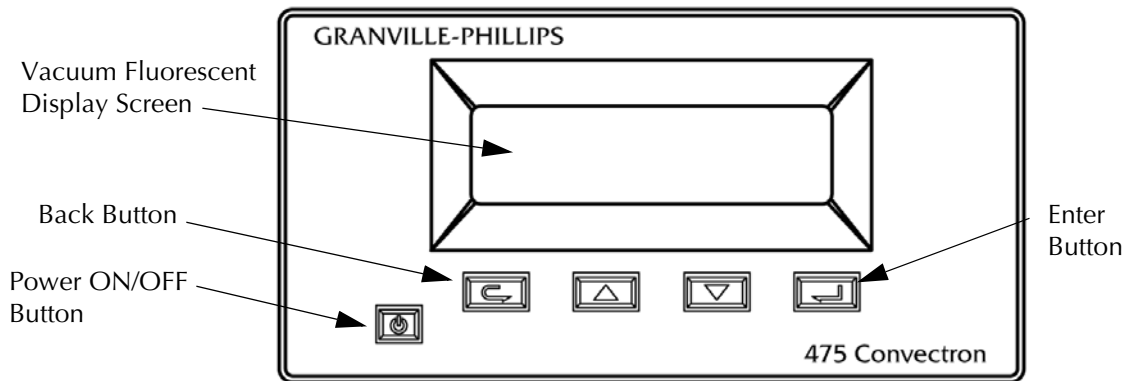

3.2 Button Overview

- The POWER button is press ON, press OFF. In case of power failure, the Controller will restart if it was ON when power was interrupted.

- Use the BACK button to exit menus.



- Use the UP and DOWN buttons to make menu selections and change parameter settings.



- Use the ENTER button to enter menus and to execute parameter changes.

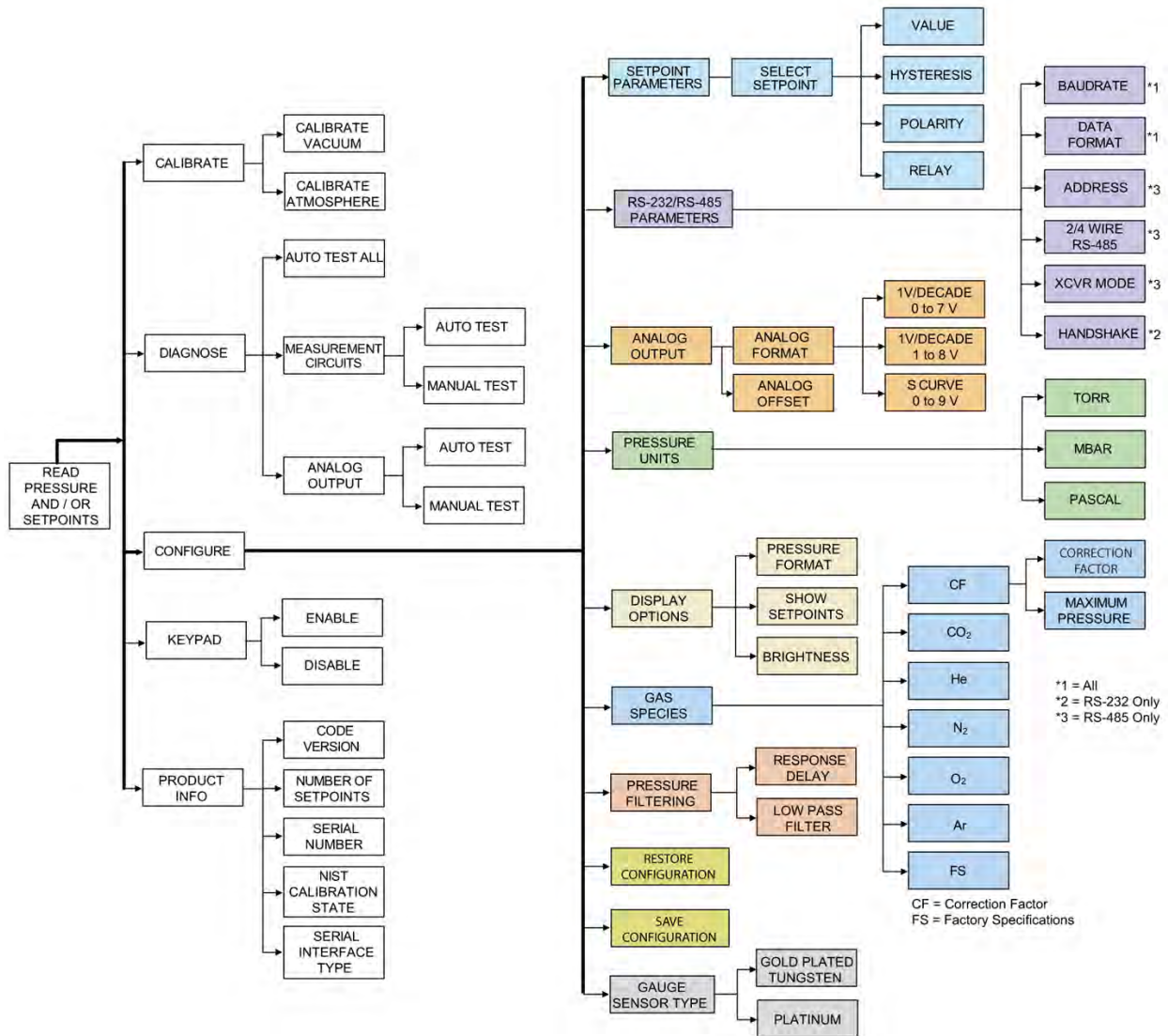

Figure 3-2 page 28 illustrates the button menu flow.

3.3 Initial Power Up

1. Press the Power ON/OFF button (see Figure 3-1). The display screen will illuminate.
2. Run the self diagnostics tests to allow the 475 Controller to perform a self diagnostics test. See *Diagnose* beginning on page 29 to run the tests.

Figure 3-2 Series 475 Convectron Gauge Controller System Menu Flowchart



3.4 Menu Overview

All functions, settings, and options can be accessed and displayed by using the four buttons on the front panel of the Controller. Some of the displayed settings are for information only, and others can be changed and saved. Use either the UP or DOWN button to scroll through the menu selections.

The five main menu selections are Calibrate, Configure, Diagnose, Keypad, and Product Info. See Figure 3-2. Each of these menu selections and their relevant sub-selections are explained in the following sections of this chapter.

When using a PC and the RS-232 option, additional information is provided in the Process Control Chapter and the RS-232 Chapter.

When using a PC and the RS-485 option, additional information is provided in the Process Control Chapter and the RS-485 Chapter.

3.4.1 Product Information

Product information allows the user to read the product revision and installed options.

1. Press the UP or DOWN button to scroll to "Product Info" and press the ENTER button.
2. Press the UP or DOWN button to browse the product information.
3. "Code Version" displays the software part number and revision.
4. "Setpoints" displays the number of relays.
5. "Serial Number" is the same as the label on the product.
6. "NIST Calibration" displays "Yes" if the gauge and Controller have been calibrated on NIST traceable instrumentation, or displays "No" if there's no NIST calibration or it has been voided. See *NIST Traceable System Calibration* on page 52 for more detailed information.
7. "Serial Interface" displays if the RS-232 or RS-485 serial interface is installed.
8. Press the BACK button a few times or wait one minute to return to pressure display.

3.4.2 Keypad

The keypad consists of five momentary switches; one is used as a power switch, four are used for user interaction with the display menu.

The keypad can be enabled or disabled.

Disabling the keypad prevents unwanted key presses. When disabled, any key press (EXCEPT the Power key) causes a "keypad disabled" notification to be shown for two seconds. The "current pressure screen" is shown by default.

1. Press the UP or DOWN button to scroll to "Keypad" and press the ENTER button.
2. Press the UP or DOWN button to select "Enable" or "Disable" and press the ENTER button.
3. Press the BACK button a few times or wait one minute to return to pressure display.
4. To re-enable the keypad, enter the sequence Up, Down, Back, Enter within five seconds.

3.4.3 Diagnose

During the diagnostics "Test Measurement" function, pressure reporting is suspended and the Convector simulator is switched ON. (See *Convector Gauge Simulator beginning on page 97*.) For the "Auto Test", the Convector simulator simulates five different equally-spaced Analog to Digital (A/D) voltages across the whole range (0.317 to 5.635V). These voltages are measured and compared by the external A/D and the internal microcontroller A/D. The Convector simulator is switched OFF, pressure reporting resumed, and a pass/fail is reported to the user. See *Chapter 7* for more information on the diagnostics.

The same process is used for the "Manual Test", except the user can enter either pressure or bridge voltage and pass/fail criteria is not determined by the microcontroller.

During the Analog Output diagnostic function, pressure reporting is suspended to the analog output, and the analog output is tested at discrete points between 0 V and 10.5 V.

1. Press the UP or DOWN button to scroll to "Diagnose" and press the

ENTER button.

2. Press the UP or DOWN button to select “Auto Test”, “Meas. Circuit”, or “Analog Output” and press the ENTER button.

- **Auto Test All**

Performs the “Auto Test” described above.

1. Press the ENTER button to allow the 475 Controller to automatically perform a self diagnostics test.

- **Test Measurement Circuit**

The “Auto Test” mode automatically tests the Measurement Circuits. In the “Manual Test” mode, you can enter a voltage signal for the Bridge Voltage, or a pressure rating to simulate system pressure.

1. Press the UP or DOWN button to select “Auto Test” or “Manual Test” and press the ENTER button.
2. In the “Auto Test” mode, press the ENTER button to allow the 475 Controller to perform the diagnostics check.
3. In the “Manual Test” mode, use the UP or DOWN button to select either Bridge Voltage or “Pressure” and press the Enter button.
4. Press the UP or Down button to enter the desired voltage in the “Bridge Voltage” mode, or the desired pressure in the “Pressure” mode.

- **Test Analog Output**

The “Auto Test” mode automatically tests the Analog Output Circuits. In the “Manual Test” mode, you can enter a voltage to apply to the Analog Output to simulate system pressure or for system setup.

1. Press the UP or DOWN button to select “Auto Test” or “Manual Test” and press the ENTER button.
2. In the “Auto Test” mode, press the ENTER button to allow the 475 Controller to perform the diagnostics check.
3. In the “Manual Test” mode, press the UP or Down button to enter the desired voltage to be output.
4. Press ENTER to perform the diagnostics check.

3.4.4 Calibrate

When the Calibrate function is selected, the 475 Controller reads the current pressure in the vacuum chamber and determines whether you can calibrate at atmosphere or vacuum based on the current pressure.

See *Calibration* and *NIST Traceable System Calibration* on page 52 for more detailed information.

1. Press the UP or DOWN button to scroll to “Calibrate” and press the ENTER button.

Either “Calibrate Vacuum” or “Calibrate Atmosphere” will be shown depending on the current reported pressure.

NOTE: “Invalid Pressure for Cal” will be displayed if the pressure is out of range to perform the calibration.

- **Calibrate Atmosphere**

1. Press the UP or DOWN button to select the desired calibration setting and press the ENTER button.
2. Press the BACK button a few times or wait one minute to return to

pressure display.

- **Calibrate Vacuum**

1. Press the UP or DOWN button to select the desired calibration setting and press the ENTER button.
2. Press the BACK button a few times or wait one minute to return to pressure display.

3.5 Configure

The Configure menu item allows the user to view, select, and set the control functions of the 475 Controller. See Figure 3-2.

3.5.1 Setpoint Parameters

Two process control setpoints provide control of other vacuum system equipment such as valves, pumps, heaters, alarms, and safety interlocking.

1. Press the UP or DOWN button to scroll to “Configure” and press the ENTER button.
2. Press the UP or DOWN button to select “Setpoint 1” or “Setpoint 2” and press the ENTER button.
3. Press the UP or DOWN button to select “Value”, “Hysteresis”, “Polarity”, or “Relay” and press the ENTER button.

Value

1. The indicated setting will show in reverse video. Press the UP or DOWN button to select the desired setpoint.
2. Press the ENTER button to save the selection.
3. Press the BACK button a few times or wait one minute to return to pressure display.

Hysteresis

1. The indicated setting will show in reverse video. Press the UP or DOWN button to select the desired “Hysteresis” percentage.
2. Press the ENTER button to save the selection.
3. Press the BACK button a few times or wait one minute to return to pressure display.

Polarity

1. The indicated setpoint polarity setting will show in reverse video. Press the UP or DOWN button to select “Normal” or “Reverse”.
2. Press the ENTER button to save the selection.
3. Press the BACK button a few times or wait one minute to return to pressure display.

Relay

1. The indicated setpoint relay enable/disable setting will show in reverse video. Press the UP or DOWN button to select “Enabled” or “Disabled”.
2. Press the ENTER button to save the selection.
3. Press the BACK button a few times or wait one minute to return to pressure display.

3.5.2 RS-232 Parameters

The RS-232 interface permits data output to, and operational control by, a host computer. Output control is either by a command-response mechanism or a hardware control line between RTS and CTS. A variety of baud rates and byte framing options are available. See *Chapter 5* for detailed information regarding the RS-232 parameters.

1. Press the UP or DOWN button to scroll to “Configure” and press the ENTER button.
2. Press the UP or DOWN button to select “RS-232 Parameters” and press the ENTER button.
3. Press the UP or DOWN button to select “Baud Rate”, “Data Format”, or “Handshake” and press the ENTER button.

Baud Rate

1. The indicated setting will show in reverse video. Use the UP and DOWN buttons to scroll to the desired Baud Rate setting.
2. Press the ENTER button to save the selection.
3. Press the BACK button a few times or wait one minute to return to pressure display.

Data Format

1. The indicated setting will show in reverse video. Use the UP and DOWN buttons to scroll to the desired Data Format setting.
2. Press the ENTER button to save the selection.
3. Press the BACK button a few times or wait one minute to return to pressure display.

Handshake

1. The indicated setting will show in reverse video. Use the UP and DOWN buttons to select “Enable” or “Disable”.
2. Press the ENTER button to save the selection.
3. Press the BACK button a few times or wait one minute to return to pressure display.

3.5.3 RS-485/422 Parameters

The RS-485 interface permits data output to, and operational control by, a host computer. A variety of baud rates and byte framing options are available. See *Chapter 6* for detailed information regarding the RS-485 parameters.

1. Press the UP or DOWN button to scroll to “Configure” and press the ENTER button.
2. Press the UP or DOWN button to select “RS-485 Parameters” and press the ENTER button.
3. Press the UP or DOWN button to select “Baud Rate”, “Data Format”, “Address”, “2/4 Wire RS-485”, or “XCVR Mode” and press the ENTER button.

Baud Rate

1. The indicated setting will show in reverse video. Use the UP and DOWN buttons to scroll to the desired Baud Rate setting.
2. Press the ENTER button to save the selection.

3. Press the BACK button a few times or wait one minute to return to pressure display.

Data Format

1. The indicated setting will show in reverse video. Use the UP and DOWN buttons to scroll to the desired Data Format setting.
2. Press the ENTER button to save the selection.
3. Press the BACK button a few times or wait one minute to return to pressure display.

Address

1. The indicated setting will show in reverse video. Use the UP and DOWN buttons to scroll to the desired Address setting.
2. Press the ENTER button to save the selection.
3. Press the BACK button a few times or wait one minute to return to pressure display.

2/4 Wire Configuration

1. The indicated setting will show in reverse video. Use the UP and DOWN buttons to scroll to the desired 2-Wire or 4-Wire configuration.
2. Press the ENTER button to save the selection.
3. Press the BACK button a few times or wait one minute to return to pressure display.

Transceiver Mode

1. The indicated setting will show in reverse video. Use the UP and DOWN buttons to scroll to the desired Transceiver Mode setting.
2. Press the ENTER button to save the selection.
3. Press the BACK button a few times or wait one minute to return to pressure display.

3.5.4 Analog Output

The Analog Output produces a DC voltage at the output with a range of at least 0 to 10.5 Vdc.

You can request a voltage value on the Analog Output so you can calibrate/verify a system. (The Controller must be in the Diagnostic menu.) You can also apply an offset to the Analog Output.

See Section 3.12 and Figure 3-11 for more detailed information.

1. Press the UP or DOWN button to select "Configure" and press the ENTER button.
2. Press the UP or DOWN button to select "Analog Output" and press the ENTER button.
3. Press the UP or DOWN button to select "Analog Format" or "Analog Offset" and press the ENTER button.

Analog Format

1. The indicated setting will show in reverse video. Press the UP or DOWN button to select the desired Analog Format voltage range.
2. Press the ENTER button to save the selection.
3. Press the BACK button a few times or wait one minute to return to

pressure display.

Analog Offset

1. The indicated setting will show in reverse video. Press the UP or DOWN button to select the desired Analog voltage offset.
2. Press the ENTER button to save the selection.
3. Press the BACK button a few times or wait one minute to return to pressure display.

3.5.5 Pressure Units

The selected pressure unit of measure will be displayed for measured pressure and setpoint pressure values.

1. Press the UP or DOWN button to select “Configure” and press the ENTER button.
2. Press the UP or DOWN button to select “Pressure Units” and press the ENTER button.
3. The indicated unit will show in reverse video. Press the UP or DOWN button to select Torr, mbar, or Pa.
4. Press the ENTER button to save the unit selection.
5. Press the BACK button a few times or wait one minute to return to pressure display.

3.5.6 Display Options

The Display Options menu allows you to select the displayed pressure format, setpoints, and the brightness of the display screen.

Pressure Format

The Display Format affects pressure notation, which can be set to scientific notation or Torr/mTorr notation (units dependent).

- Scientific notation provides a consistent display width.
 - Torr/mTorr format is similar to that of the Series 375 Controller.
1. Press the UP or DOWN button to select “Configure” and press the ENTER button,
 2. Press the UP or DOWN button to select “Display Options” and press the ENTER button.
 3. Press the UP or DOWN button to select “Pressure Format” and press the ENTER button.
 4. Press the UP or DOWN button to select “Torr/mTorr” or “Scientific” and press the ENTER button to save the selected format.
 5. Press the BACK button a few times or wait one minute to return to the pressure display.

Show Setpoints

The pressure display may be set so it shows pressure only or shows pressure and setpoint status. When pressure only is selected, the font is larger and can be seen from a greater distance. When setpoint status is shown, status and pressure will be shown. Setpoint status is indicated by a rectangle icon that will be filled if the relay is energized or open if the relay is not energized. See *Figure 3-3*.

1. Press the UP or DOWN button to select “Configure” and press the ENTER button.

2. Press the UP or DOWN button to select “Display Options” and press the ENTER button.
3. Press the UP or DOWN button to select “Show Setpoints” and press the ENTER button.
4. Press the UP or DOWN button to change the setpoint display status to “Yes” or “No”.
5. Press the ENTER button to save the show setpoints parameter.
6. Press the BACK button a few times or wait one minute to return to pressure display.

Figure 3-3 Setpoint Indicators

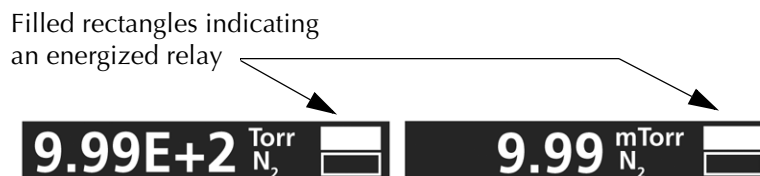

Brightness

The display brightness (1, 2, or 3) can be adjusted to a preferred level. Setting the display to a lower brightness will extend the life of the display. The factory default setting is 3.

1. Press the UP or DOWN button to select “Configure” and press the ENTER button.
2. Press the UP or DOWN button to select “Display Options” and press the ENTER button.
3. Press the UP or DOWN button to select “Brightness” and press the ENTER button.
4. Press the UP or DOWN button to change the brightness of the display.
5. Press the ENTER button to save the display brightness setting.
6. Press the BACK button a few times or wait one minute to return to pressure display.

3.5.7 Gas Species

The selected gas species will be displayed and can be changed to another type of gas.

The Controller is calibrated for N₂ unless otherwise displayed on the front panel for custom applications. When a gas other than N₂ is selected, the *Indicated vs. True Pressure* charts listed in *Indicated vs. True Pressure for Gases Other Than N₂ or Air* beginning on page 42 are not required.

The 475 Controller uses a lookup table of bridge voltages and pressures to convert the voltage given from the A/D to a pressure. Lookup tables exist for N₂ (default), Ar, He, CO₂, and O₂. A Factory-Specified (FS) lookup table may also exist.

In addition, a Correction Factor (CF) can be applied when a gas other than N₂ is a constant multiplication factor (rather than a curve) of N₂. See the graphs in *Indicated vs. True Pressure for Gases Other Than N₂ or Air* on page 42. This is only accurate at low pressures and has a range of 0.1 to 5 in increments of .01. The CF gas setting can be selected and programmed by

using the Menu buttons on the front of the Controller. See *Correction Factor Parameters* on page 38.

At the time the gas species is changed, a pressure high-limit is changed so that a warning is given of possible over-pressure conditions. If a correction factor is entered, you can enter an upper limit.

An example process:

- Switch gas species from N₂ to Ar.
 - Pressure conversion switches to the Ar curve.
 - The over-pressure error limit is changed to reflect Ar.
1. Press the UP or DOWN button to select “Configure” and press the ENTER button.
 2. Press the UP or DOWN button to select “Gas Species” and press the ENTER button.
 3. The indicated unit will show in reverse video. Press the UP or DOWN button to select N₂, Ar, CF (Correction Factor), or FS (Factory Specification).
 4. Press the ENTER button to save the gas species selection.
 5. Press the BACK button a few times or wait one minute to return to pressure display.

3.5.8 Pressure Filtering

Pressure Filtering allows additional filtering of the pressure reading. You can set the delay time in milliseconds for the 475 Controller to display a pressure reading, and Enable or Disable the Low-Pass Filter. “Response Delay” provides a delayed readout of the indicated pressure.

1. Press the UP or DOWN button to select “Configure” and press the ENTER button.
2. Press the UP or DOWN button to select “Pressure Filtering” and press the ENTER button.
3. Press the UP or DOWN button to select “Response Delay” or “LPF” (Low-Pass Filter).
4. Press the ENTER button to open the selection.

Response Delay

1. The indicated unit will show in reverse video. Press the UP or DOWN button to select the desired delay time.
2. Press the ENTER button to save the time selection.
3. Press the BACK button a few times or wait one minute to return to pressure display.

LPF (Low-Pass Filter)

1. The indicated unit will show in reverse video. Press the UP or DOWN button to select Enable or Disable.
2. Press the ENTER button to save the selection.
3. Press the BACK button a few times or wait one minute to return to pressure display.

3.5.9 Restore Configuration

“Restore Configuration” allows the user to switch to any of the four saved configurations. Four different configurations (one factory default and three user-set configurations) can be programmed and saved. Each user setting will include unique setpoint parameters, unit of measure, analog output setting, computer interface parameters, atmosphere and vacuum calibrations, gas species setting, and display options. Initial user settings are programmed to the factory defaults.

1. Press the UP or DOWN button to select “Configure” and press the ENTER button.
2. Press the UP or DOWN button to select “Restore Config.” and press the ENTER button.
3. The indicated unit will show in reverse video. Press the UP or DOWN button to select 1, 2, 3, or Defaults.
4. Press the ENTER button to save the selection.
5. Press the BACK button a few times or wait one minute to return to pressure display.

3.5.10 Save Configuration

“Save Configuration” allows the user to save up to three configurations in addition to the factory default configuration. Three different user settings can be programmed and saved. Each user setting will include unique setpoint parameters, unit of measure, analog output setting, computer interface parameters, atmosphere and vacuum calibrations, gas species setting, and display options.

1. Press the UP or DOWN button to select “Configure” and press the ENTER button.
2. Press the UP or DOWN button to select “Save Config.” and press the ENTER button.
3. The indicated unit will show in reverse video. Press the UP or DOWN button to select 1, 2, or 3.
4. Press the ENTER button to save the selection.
5. Press the BACK button a few times or wait one minute to return to pressure display.

3.5.11 Gauge Sensor Type

“Sensor Type” allows the user to set the type of sensor in the Convector Gauge. The most common type of sensor used in the Convector Gauge is Gold-plated Tungsten. However, a Platinum sensor is used for some applications where chemically corrosive gases such as chlorine, fluorine, or mercury vapor are used. Check the list of Convector Gauge catalog numbers on page 4 of this manual to determine which type of sensor is in the Convector Gauge on your system.

1. Press the UP or DOWN button to select “Configure” and press the ENTER button.
2. Press the UP or DOWN button to select “Gauge Sensor Type” and press the ENTER button.
3. The indicated unit will show in reverse video. Press the UP or DOWN button to select Gold-Tungsten or Platinum.
4. Press the ENTER button to save the selection.
5. Press the BACK button a few times or wait one minute to return to pressure display.

3.5.12 Correction Factor Parameters

The Correction Factor is a scaling of a pressure reading to a new reading. The Correction Factor (CF) can be applied when a gas other than N_2 is a constant multiplication factor (rather than a curve) of N_2 . See the graphs in *Indicated vs. True Pressure for Gases Other Than N_2 or Air* on page 42. This is only accurate at low pressures and has a range of 0.1 to 5 in increments of .01.

1. Press the UP or DOWN button to select "Configure" and press the ENTER button.
2. Press the UP or DOWN button to select "Gas Species" and press the ENTER button.
3. Press the UP or DOWN button to select "Correction Factor" and press the ENTER button.
4. Press the ENTER button again to highlight the current CF setting.
5. Press the UP or DOWN button to select the desired Correction Factor (0.1 to 5) and press the ENTER button to save the new CF setting.
6. Press the BACK button a few times or wait one minute to return to pressure display.

Maximum Pressure

When a gas species is changed, a pressure high-limit must be entered so a warning is given of possible over-pressure conditions. If a correction factor is entered, you can enter an upper limit.

1. Press the UP or DOWN button to select "Configure" and press the ENTER button.
2. Press the UP or DOWN button to select "Gas Species" and press the ENTER button.
3. Press the UP or DOWN button to select "Correction Factor" and press the ENTER button.
4. Press the ENTER button again to highlight the current CF setting.
5. Press the UP or DOWN button to select "Max Pressure".
6. Press the ENTER button to open the "Max Pressure". Press the ENTER button to display the current Maximum Pressure setting.
7. Press the UP or DOWN button to select the desired Maximum Pressure Setting (1 mTorr to 999 Torr) and press the ENTER button to save the new setting.
8. Press the BACK button a few times or wait one minute to return to pressure display.

3.6 Error Codes

A known error produces an error code that is displayed to the user. More than one error results in a rotation of errors on the display. An error is also reported to the user through digital communications.

When there are errors, the pressure readout is readjusted to a smaller font.

Table 3-1 Series 475 Controller Error Codes

Error Code	Comm Error Code for "RD"	Error	Comments
ERR 01 CGBAD	OPN SNSR	The Convectron Gauge is either unplugged or defective	Reported pressure is 999T, relays OFF
ERR 09 NVRAM		Not able to retrieve information from EEPROM	
ERR 14 CABLE	SNSR UNP	The cable is either unplugged or defective	Reported pressure is 999T, relays OFF
ERR 15 ADBAD		The A/D Converter is reporting an erroneous value	Reported pressure is 999T, relays OFF
ERR 16 AOBAD		The Analog Output is reporting an erroneous value	
ERR 17 OVPRS	SNSR OVP	The maximum pressure limit has been reached	Reported pressure is max reported pressure for gas species (999 Torr for N ₂)
ERR 18 FAC		CRC-16 checksum verification of factory settings failed	Revert to the hardcoded values
ERR 19 FS		CRC-16 checksum verification of "FS" curve failed	Revert to the N ₂ curve

3.7 Preparing For Convectron Gauge Operation

Convectron Gauge pressure is indicated on the Controller front panel display.

Install pressure limiting devices calibrated to a level that the vacuum system can safely withstand. In addition, install pressure relief valves or rupture disks that will release pressure at a level considerably below the maximum safe pressure level of the system. Confirm that these safety devices are properly installed before installing the Controller.

In addition, make sure:

- The proper gas cylinders are installed,
- Gas cylinder valve positions are correct on manual systems, and
- The automation settings are correct on automated gas delivery systems.

Vacuum gauges with compression fittings may be forcefully ejected if the vacuum system is pressurized.

3.8 Convectron Gauge Theory of Operation

The Convectron Gauge transducer is represented in Figure 3-4 as R1, R2, R3, and R4. These four resistances form the legs of a bridge circuit, with R1 designating the sensor wire of the transducer. R2 is a resistive network in the gauge tube that compensates for changes in the ambient temperature. At bridge null, $R1 = R2 \times R3 / R4$. If there are no changes in ambient temperature, the value of R1 is a constant and the bridge is balanced.

Figure 3-4 Convectron Gauge Schematic

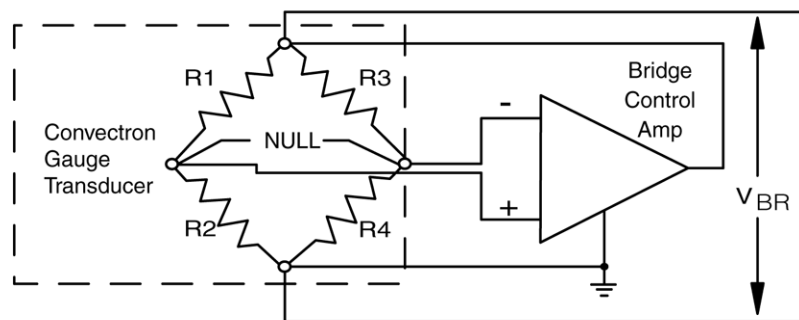

The Convectron Gauge operates like a standard Pirani gauge, which employs the principle of a Wheatstone bridge to convert pressure to voltage, but uses convection cooling to enable accurate pressure measurement, when properly calibrated, from 10^{-4} to 1000 Torr. The sensing wire is an ultra-fine strand of gold-plated tungsten or solid platinum.

As the vacuum system pressure is decreased, there are fewer molecules in the system to conduct the heat away from the sensor wire causing the temperature and resistance of R1 to increase. The increased resistance of R1 causes the bridge to unbalance and a voltage is developed across the null terminals. The bridge control circuit senses the null voltage and decreases the voltage across the bridge until the null voltage is again zero. When the bridge voltage is decreased, the power dissipated in the sensor wire is decreased causing the resistance of R1 to decrease to its previous value. The opposite events happen for a pressure increase. The bridge voltage is a nonlinear function of pressure.

3.9 Convectron Gauge Sensors

Using Sensors other than Gold-Plated Tungsten

Another factor that affects the bridge voltage vs. pressure relationship is the type of sensor wire used in the 275 Convectron Gauge, which is either a gold-plated tungsten (common) or a platinum sensor wire. The platinum sensor is used only in some applications that are corrosive to the gold-plated tungsten sensor.

Like the gas species, the 475 Controller is also able to change the bridge voltage vs. pressure relationship for different sensor types. And, like the gas species, the Controller also has different user calibrations for each sensor type. Switching the sensor type also switches the user calibration. See *Gauge Sensor Type* on page 37 to change the setting in the Controller.

3.10 Using Gases Other than N₂ or Air

The 475 Convectron Gauge Controller calculates pressure by:

- balancing the Convectron bridge,
- measuring the bridge voltage,
- applying any "user calibration" settings, and
- looking up the corresponding pressure in a bridge voltage vs. pressure table.

Among other factors, the bridge voltage vs. pressure relationship is dependent on the gas species in the system. The gas species, and therefore the bridge voltage vs. pressure relationship, can be changed through the front panel of the Controller, or through the RS-232 or RS-485 interface.

See *Gas Species* on page 35 to select and use correction parameters when using Ar, He, CO₂, or O₂.

3.10.1 Effects on User Calibration

The 475 Controller has a different user calibration for each gas species (Ar, He, CO₂, or O₂) except "CF" (which uses N₂ calibration) and "FS" (where the calibration is built into the lookup-table). Switching the gas species automatically switches the user calibration. Resetting the calibration to factory defaults only affects the gas species currently in use.

Calibrating for each gas species provides more accurate pressure readings.

Correction Factor (CF)

The correction factor (CF function) can be used at low pressures on the Convectron Gauge when most gases are proportional to N₂ and the proportion is known. The Controller uses the N₂ bridge voltage vs. pressure relationship (and user calibration) and multiplies it by the correction factor -

$$(P_{new}) = (P_{N_2})(CF)$$

Factory Specified (FS)

The factory specified function can be used when the factory, at the request of the customer, has loaded a bridge voltage vs. pressure relationship that is specific to the Controller - cable - gauge combination. Contact MKS for more details.

3.10.2 Indicated vs. True Pressure for Gases Other Than N₂ or Air

NOTE: Use the information in this section only if you are NOT using the Calibrated Gas Species function of the 475 Controller. The 475 Controller uses lookup tables of bridge voltages and pressures to convert the voltage given from the Analog-to-Digital converter (A/D) to a pressure reading. Factory-programmed lookup tables exist for N₂ (default), Ar, He, CO₂, and O₂.

WARNING

If accurate conversion data is not used, or is improperly used, a potential overpressure explosion hazard can be created under certain conditions. Using the N₂ calibration to pressurize a vacuum system above about 1 Torr with certain other gases can cause dangerously high pressures which may cause explosion of the system.

Convectron Gauges are Pirani type thermal conductivity gauges. These gauges measure the heat loss from a heated sensor wire maintained at constant temperature. The Controller converts this measurement into gas pressure readings. For gases other than nitrogen or air the heat loss varies at any given true pressure and can result in inaccurate pressure readings.

It is important to understand that the pressure indicated by a Convectron Gauge depends on the type of gas, the orientation of the gauge axis, and the gas density in the gauge. Convectron Gauges are normally factory calibrated for N₂ (air has approximately the same calibration). With proper precautions, the Convectron Gauge may be used for pressure measurement of certain other gases.

At pressures below a few Torr, there is no danger in measuring pressure of gases other than N₂ and air, merely inaccurate readings. A danger arises if the N₂ calibration is used without correction to measure higher pressure levels of some other gases. For example, N₂ at 24 Torr causes the same heat loss from the Convectron sensor as argon will at atmospheric pressure. If the pressure indication of the Convectron Gauge is not properly corrected for argon, an operator attempting to fill a vacuum system with 1/2 atmosphere of argon would observe a pressure reading of only 12 Torr when the actual pressure had risen to the desired 380 Torr. Continuing to fill the system with argon to 760 Torr would result in a 24 Torr pressure reading.

Depending on the pressure of the argon gas source, the chamber could be dangerously pressurized while the display continued to read about 30 Torr of N₂ equivalent pressure. This type of danger is not unique to the Convectron Gauge and likely exists with other thermal conductivity gauges using convection to extend the range to high pressures.

To measure the pressure of gases other than air, or N₂ with a Convectron Gauge calibrated for N₂, you must use the conversion curves listed specifically for Convectron Gauges to translate between indicated N₂ pressure and true pressure, or use the correct gas species setting. The gas species settings can be selected by using the Menu buttons on the front of the Controller. **Do not use other data. Never use the conversion curves designed for Convectron Gauges to translate pressure readings for gauges made by other manufacturers.** Their geometry is very likely different and dangerously high pressures may be produced even at relatively low pressure indications.

You must ensure that the atmosphere adjustments for the Convector Gauge are correctly set. (See *Atmosphere Calibration* on page 51.)

Figure 3-5 through Figure 3-10 show the true pressure vs. indicated pressure for 11 commonly used gases. Table 3-2 will help to locate the proper graph.

Table 3-2 Pressure vs. Indicated N₂ Pressure Curve

Figure Number	Pressure Range and Units	Gases
Figure 3-5	10 ⁻⁴ to 10 ⁻¹ Torr	All
Figure 3-6	10 ⁻¹ to 1000 Torr	Ar, CO ₂ , CH ₄ , Freon 12, He
Figure 3-7	10 ⁻¹ to 1000 Torr	D ₂ , Freon 22, Kr, Ne, O ₂
Figure 3-8	10 ⁻⁴ to 10 ⁻¹ mbar	All
Figure 3-9	10 ⁻¹ to 1000 mbar	Ar, CO ₂ , CH ₄ , Freon 12, He
Figure 3-10	10 ⁻¹ to 1000 mbar	D ₂ , Freon 22, Kr, He, O ₂

Note that 1 mbar = 100 Pa, so the mbar charts may be used for Pascal units by multiplying the values on the axes by 100.

A useful interpretation of these curves is, for example, that at a true pressure of 2×10^{-2} Torr for CH₄ the heat loss from the sensor is the same as at a true pressure of 3×10^{-2} for N₂ (see Figure 3-5). The curves at higher pressure vary widely from gas to gas because thermal losses at higher pressures are greatly different for different gases.

If you must measure the pressure of gases other than N₂ or air use Figure 3-5 through Figure 3-10 to determine the maximum safe indicated pressure for the other gas as explained in the examples that follow.

3.10.3 Examples

Example 1: Maximum safe indicated pressure

Assume a given vacuum system will withstand an internal pressure of 2000 Torr or 38.7 psia. For safety, you want to limit the maximum internal pressure to 760 Torr during the backfilling process. Assume you want to measure the pressure of Freon 22. On Figure 3-6, locate 760 Torr on the left hand scale, travel to the right to the intersection with the Freon 22 curve, then down to an indicated pressure of 11 Torr (N₂ equivalent). In this hypothetical situation, the maximum safe indicated pressure for Freon 22 is 11 Torr.

For the sake of safety, it is prudent to place a warning label on the instrument face stating "DO NOT EXCEED 11 TORR FOR FREON 22" for this example.

Example 2: Indicated to true pressure conversion

Assume you want to determine the true pressure of helium in a system when the Convector is indicating 10 Torr. On Figure 3-6, follow the vertical graph line up from the 10 Torr (N₂ equivalent) indicated pressure to the Helium curve, then move horizontally to the left to reveal a true pressure of 4.5 Torr. Thus 4.5 Torr Helium pressure produces an indication of 10 Torr (N₂ equivalent).

Example 3: True to indicated pressure conversion

Assume you want to set a process control setpoint at a true pressure of 20 Torr of CO₂. On Figure 3-6, locate 20 Torr on the true pressure scale, travel horizontally to the right to the CO₂ curve, then down to an indicated pressure of 6.4 Torr (N₂ equivalent). The correct process control setting for 20 Torr of CO₂ is 6.4 Torr (N₂ equivalent).

Example 4: True to indicated pressure conversion

Assume you want to obtain a helium pressure of 100 Torr in the system. On Figure 3-6, locate 100 Torr on the left hand scale, travel horizontally to the right to attempt to intersect the He curve. Because the intersection is off scale, it is apparent that this true pressure measurement requirement for helium exceeds the capability of the instrument.

For gases other than those listed, the user must provide accurate conversion data for safe operation. The Convectron Gauge is not intended for use above approximately 1000 Torr true pressure.

Figure 3-5 Convectron Gauge Indicated vs. True Pressure Curve; 10^{-4} to 10^{-1} Torr

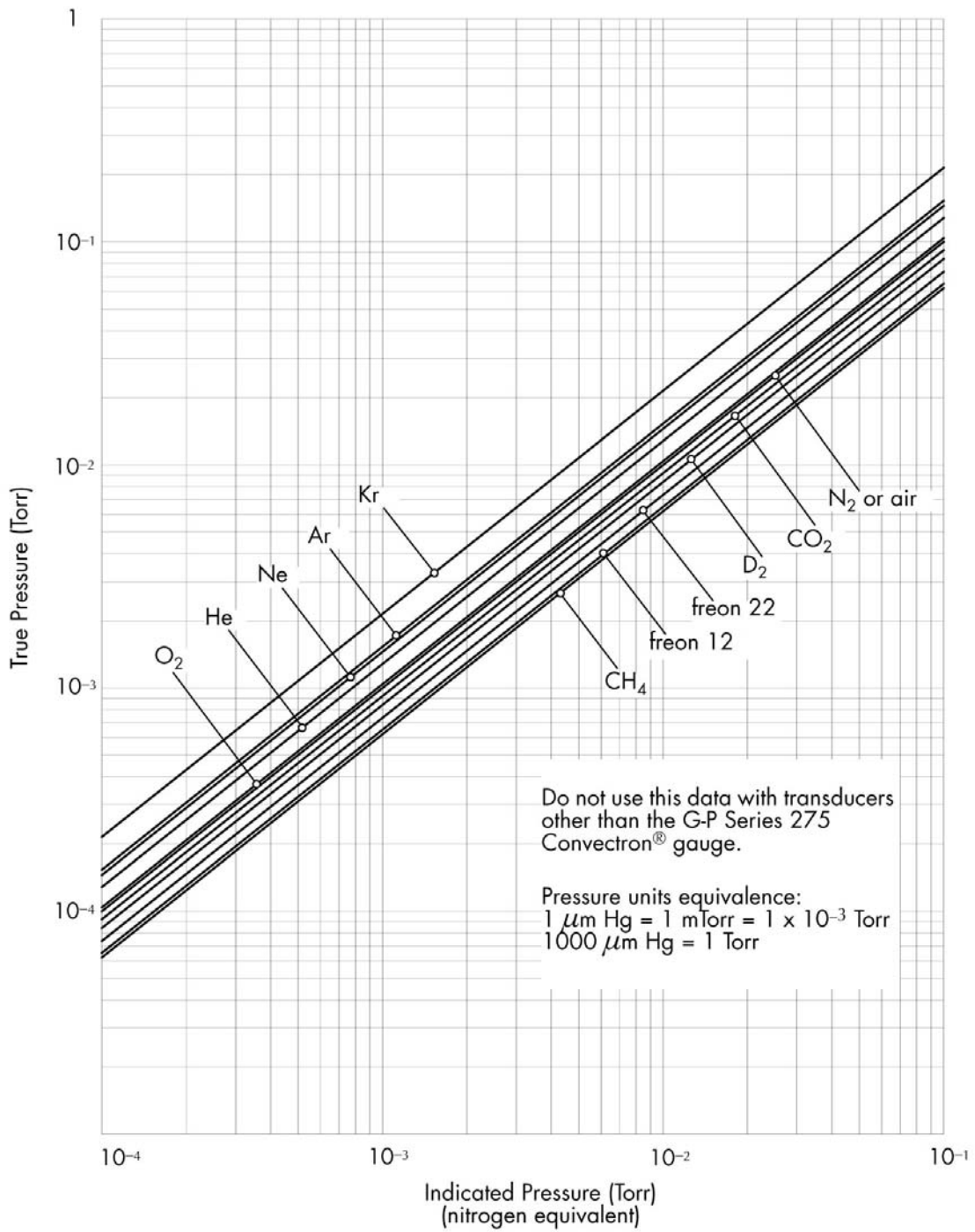

Figure 3-6 Convectron Gauge Indicated vs. True Pressure Curve; .01 to 1000 Torr

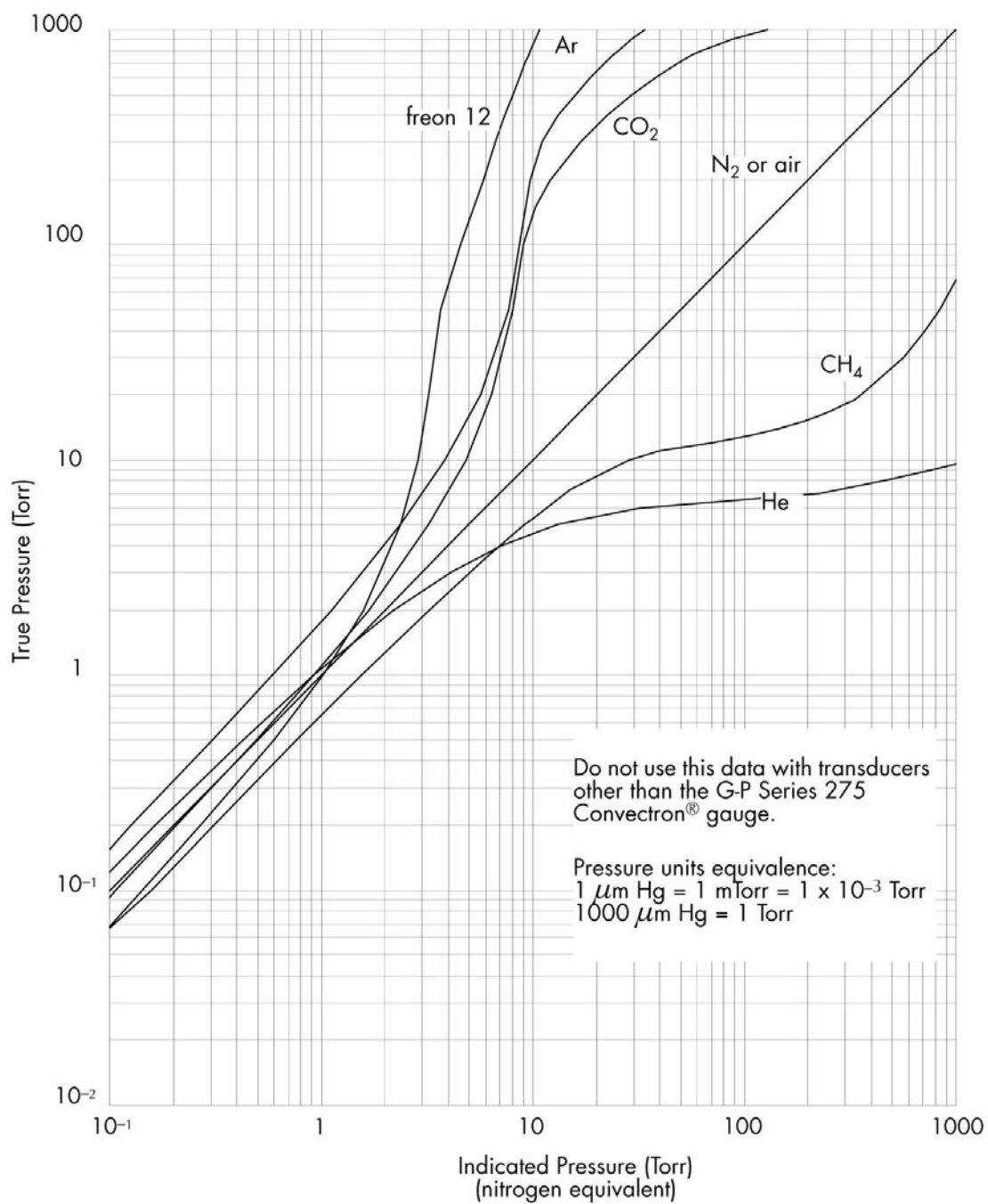

Figure 3-7 Convectron Gauge Indicated vs. True Pressure Curve; .01 to 1000 Torr

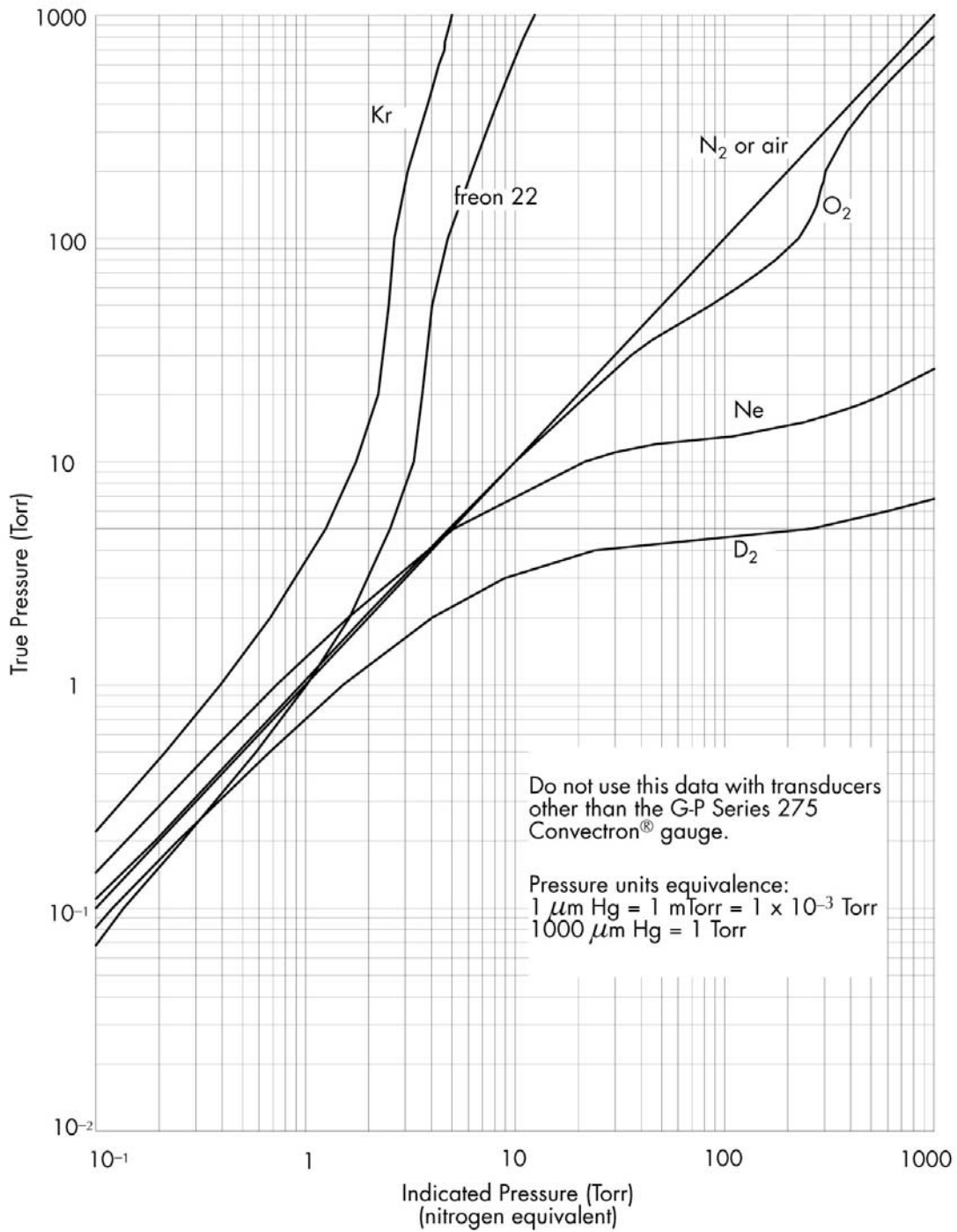

Figure 3-8 Convectron Gauge Indicated vs. True Pressure Curve; 10^{-4} to 10^{-1} mbar

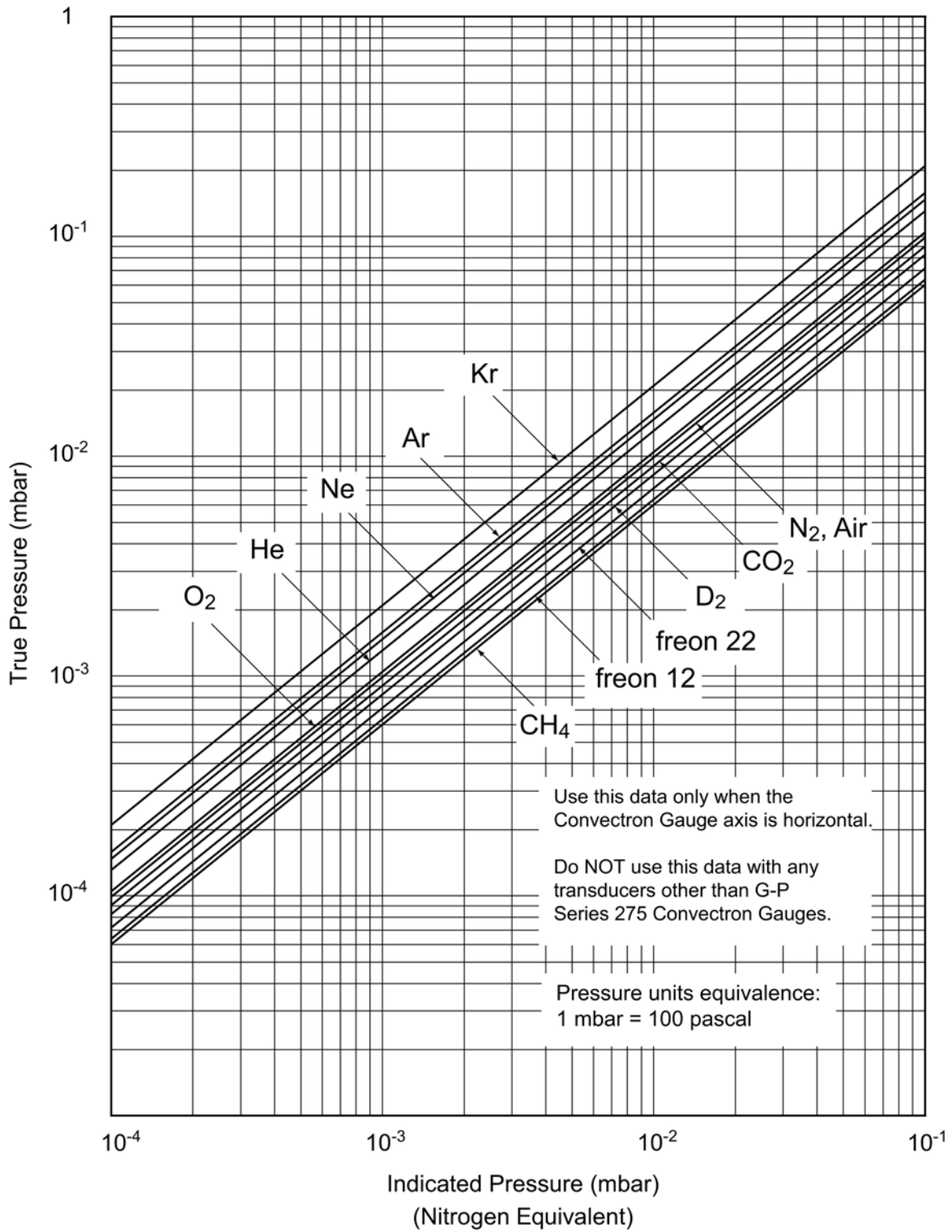

Figure 3-9 Convectron Gauge Indicated vs. True Pressure Curve; .01 to 1000 mbar

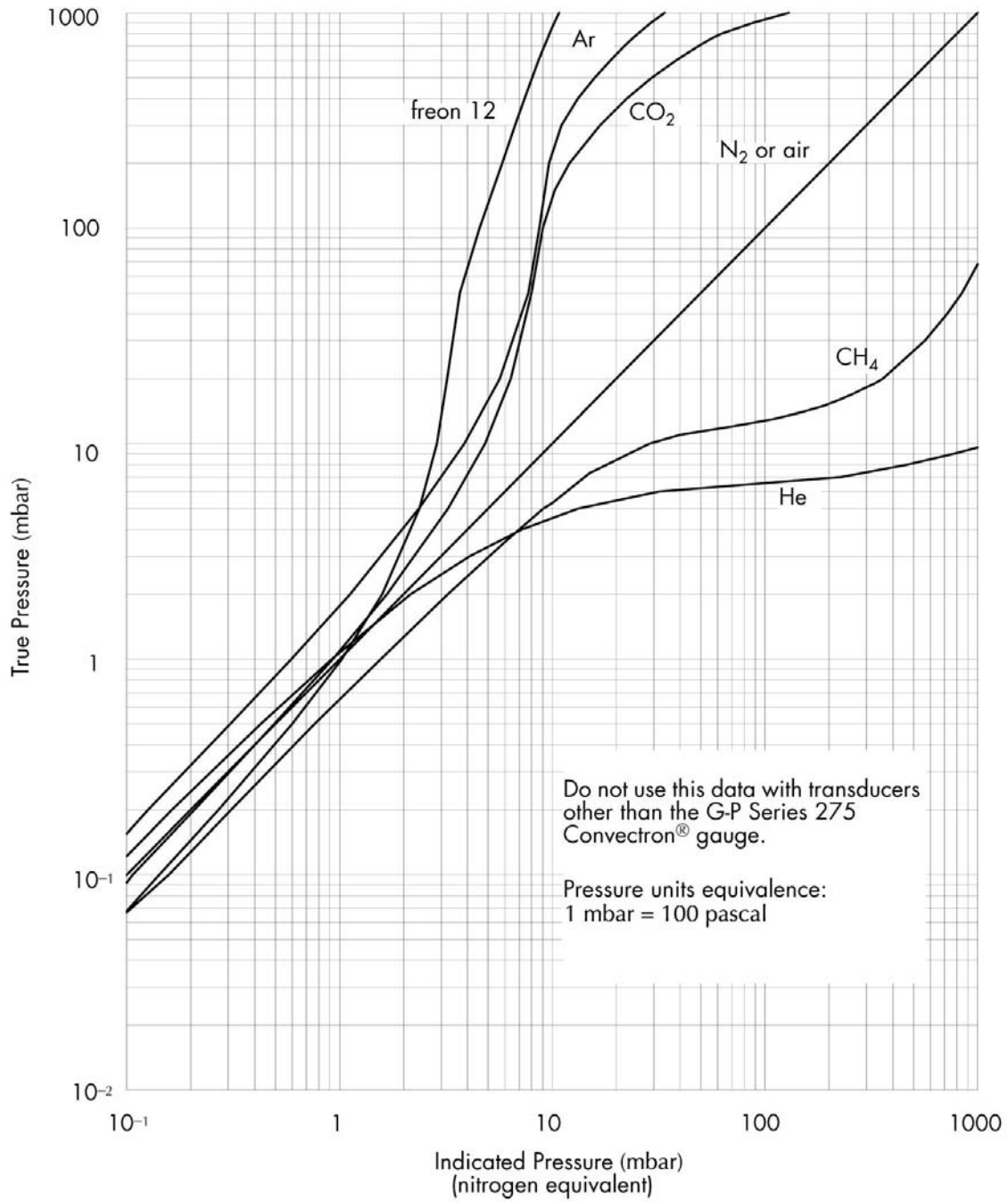
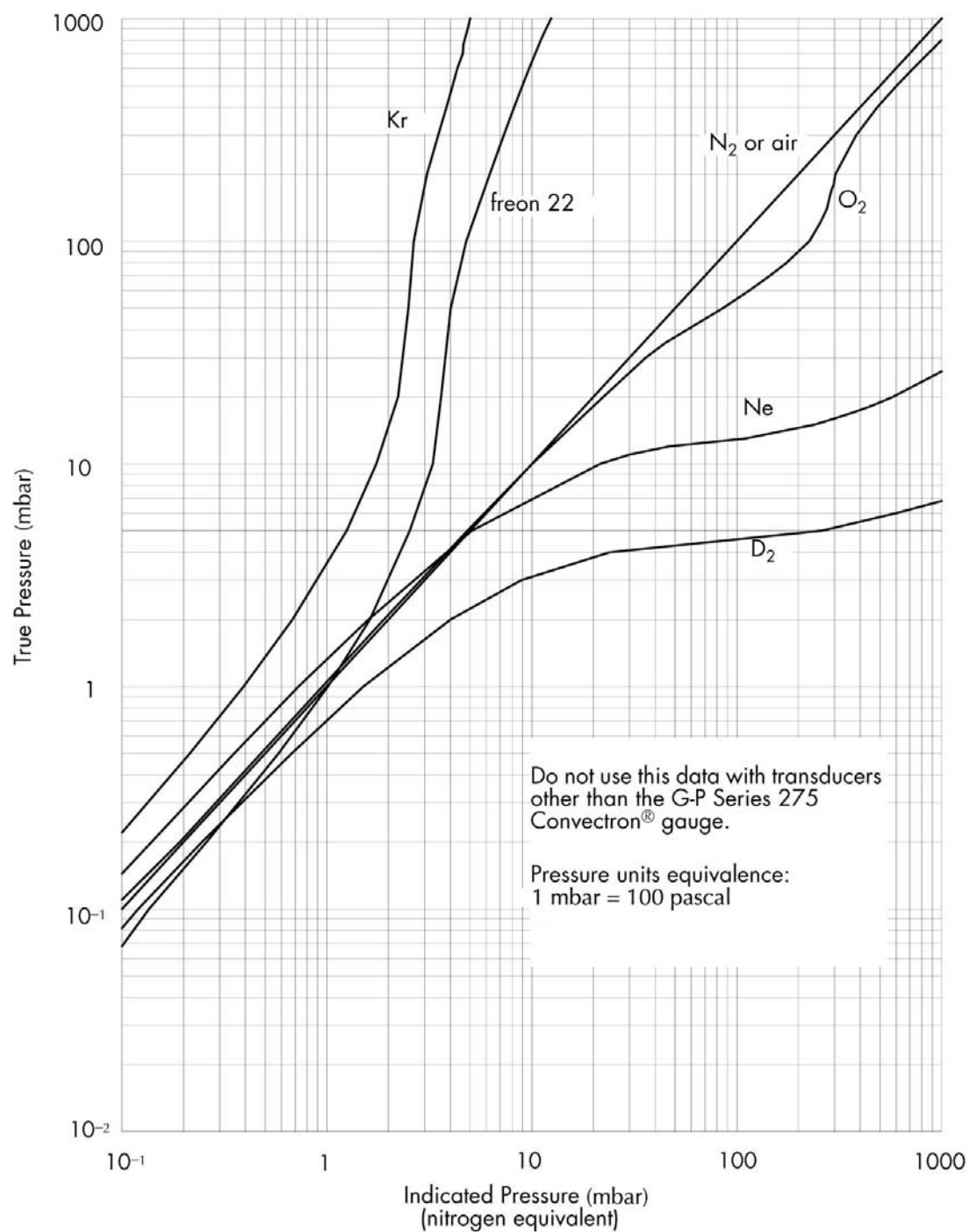

Figure 3-10 Convectron Gauge Indicated vs. True Pressure Curve; .01 to 1000 mbar



3.11 Calibration

Each Convector Gauge is individually calibrated for N₂. “Zero” adjustment of the gauge should not be necessary unless readout accuracy is required below 1×10^{-3} Torr or the gauge has been contaminated. Adjustment of the atmospheric indication should not be necessary unless compensating for long cables, variations in mounting orientation, or contamination.

The Convector Gauge has a stable, temperature compensated design. Each Controller is also calibrated to provide accurate readout of N₂ pressure with any Convector Gauge when the gauge is properly installed with the gauge axis horizontal.

3.11.1 Calibration Ranges for Different Gas Species

Calibration is possible only within certain pressure ranges. The ranges are gas specific as listed below.

Table 3-3 Calibration Limits

Gas Species	Sensor Type	Calibration Limit at Atmosphere (Torr)	Calibration Limit at Vacuum (Torr)
Nitrogen (N ₂)	Gold-Tungsten or Platinum	400 to 999	0 to 0.1
Argon (Ar)	Gold-Tungsten or Platinum	400 to 999	0 to 0.1
Helium (He)	Gold-Tungsten	1 to 8	0 to 0.1
Helium (He)	Platinum	1 to 6	0 to 0.1
Carbon Dioxide (CO ₂)	Gold-Tungsten or Platinum	400 to 999	0 to 0.1
Oxygen (O ₂)	Gold-Tungsten or Platinum	400 to 999	0 to 0.1

3.11.2 Vacuum Calibration

Evacuate the Convector Gauge to a pressure less than 100 mTorr. If the calibration is for 0.0, evacuate to less than 1×10^{-5} Torr and allow system to stabilize for 15 minutes,

1. Press the UP or DOWN button until “Calibrate” is displayed and press the ENTER button. “Calibrate VAC 0.0” is displayed.
2. If “Invalid Pressure for CAL” or “Invalid Function NIST CAL” is displayed, calibration will not be possible.
3. Press the ENTER button to calibrate at vacuum or press the UP or DOWN button to calibrate at any pressure between 0.0 and 100 mTorr, then press the ENTER button to calibrate.

3.11.3 Atmosphere Calibration

Allow the pressure in the Convector Gauge to rise above the Calibration Limit shown in Table 3-3. Read the local atmospheric pressure on an accurate barometer.

1. Press the UP or DOWN button until “Calibrate” is displayed and press the ENTER button. “Calibrate ATM 760” (actual reading) is displayed.
2. If “Invalid Pressure for CAL” or “Invalid Function NIST CAL” is displayed, calibration will not be possible.
3. Press the UP or DOWN button to calibrate at any pressure between 400 and 999 Torr, then press the ENTER button to calibrate.

To reset VAC and ATM back to their original factory settings, turn OFF the Controller and hold the ENTER button while turning ON power to the Controller. "Factory CAL" is displayed for approximately three seconds. The Controller will then resume normal power-on operation.

3.11.4 Convectron Gauge Use Below 10^{-3} Torr

During a fast pumpdown from atmosphere, thermal effects will prevent the Convectron Gauge from tracking pressure accurately below 10^{-3} Torr. After waiting about 15 minutes, indications in the 10^{-4} range will be valid and response will be rapid. Zero adjustment at vacuum may be performed at this time (or sooner if readings in the 10^{-4} range are not needed). In the 10^{-4} Torr range, the indication is resolved to about 0.1 mTorr provided the instrument has been carefully zeroed at vacuum. For accurate use in the 10^{-4} range, zeroing should be repeated frequently.

3.11.5 NIST Traceable System Calibration

Brooks Automation offers a calibration service for the Series 475 Convectron Gauge Controller. A Controller and Convectron Gauge tube are calibrated as a system, the built-in calibration functions of the Controller are locked, and a calibration certificate is provided to the customer.

NOTE: When using a 475 Controller that is NIST calibrated for a specific gas, selecting any function to change the gas species or calibration will cause the display panel to indicate INVALID.

Controller Function After NIST Calibration

The "Product Info" menu will display "NIST Calibration Yes". The Controller cannot be calibrated: the "Calibrate VAC or ATM" menu indicates "INVALID", and the TS, TZ and FAC commands of the computer interface respond with "INVALID."

Voiding the NIST Calibration

To set VAC or ATM, thereby voiding the NIST traceable calibration, you must first unlock the calibration functions. Hold down the BACK and UP buttons during power up, or send the VC (Void Calibration) command through the computer interface. The "Product Info" menu will display "NIST Calibration NO" to indicate that the Controller can now be calibrated. The Controller can then be calibrated at vacuum or atmosphere as described in *Vacuum Calibration* and *Atmosphere Calibration* on page 51.

NOTE: Once the NIST calibration has been voided, the settings cannot be restored. The Controller and Convectron Gauge must be returned to the factory for NIST calibration.

Hold down the ENTER button during power up to restore the factory calibration settings, but not the NIST calibration settings.

**3.12 Convectron Gauge
Analog Output Signal**

A voltage output signal proportional to the common logarithm of the pressure indication is provided on the rear panel of the Controller via a standard 1/8 inch miniature phone jack.

If graphed on loglinear axes, the output voltage is linear in proportion to the log of pressure (see Figure 3-11). The analog output is 1 volt per decade of pressure with a factory adjusted output of 0 volts at 1.0×10^{-4} Torr. An alternate analog output format that has a built-in 1 Volt offset, which has 1 V to 8 V range, can be selected.

The voltage signal is smooth and continuous throughout all the decades of pressure measurement. This format is useful for computerized data acquisition because a simple equation (finding the common antilogarithm) may be programmed to calculate pressure from the voltage output.

An output voltage of 10 V indicates the gauge is unplugged or faulty.

Also, a selectable non-linear (S-curve) signal (0 to 9 V) that is backwards compatible with older Convectron Gauge Controllers is available.

In addition, a programmable offset of 0.1 V to 0.5V can be entered for the analog output signal. The offset voltage signal can be selected and programmed by using the Menu buttons on the front of the Controller.

Figure 3-11 Convectron Gauge Analog Output vs. Pressure

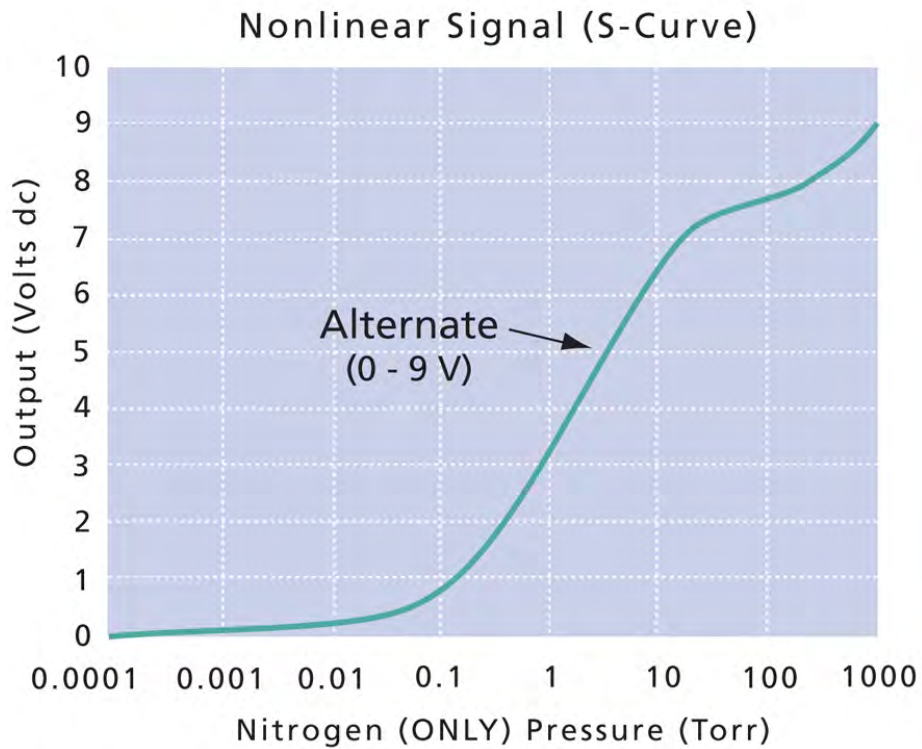
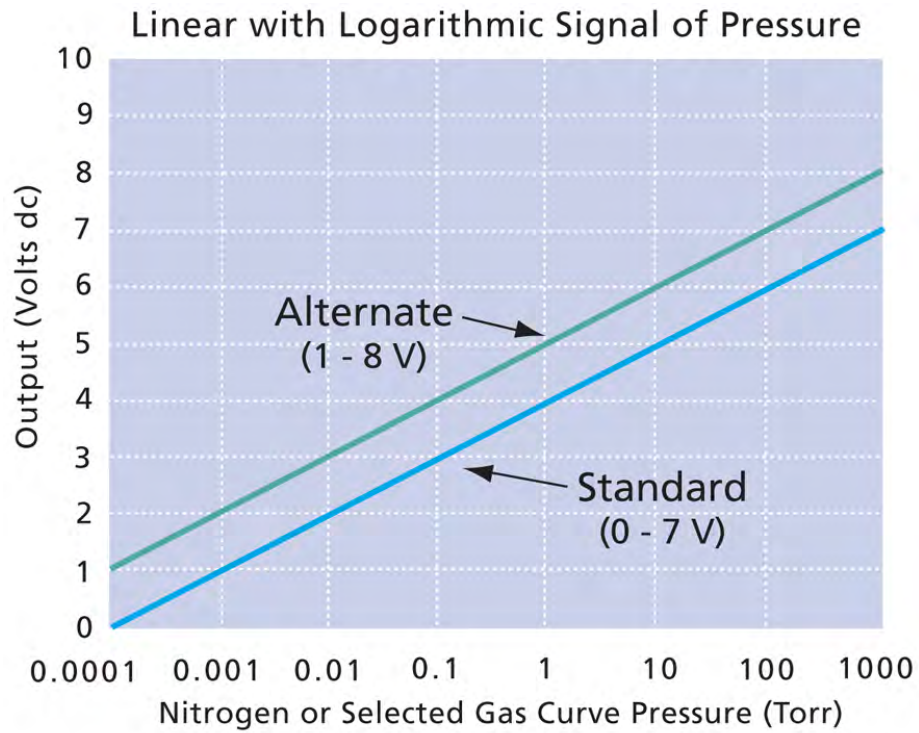

3.12.1 Default Analog Output of 0 to 7 V

The output equations for 0 to 7 V are:

$$P = 10^{V-4} \text{ Torr} \quad (P = \text{Pressure})$$

$$P = 10^{V-4} \text{ mbar} \quad (V = \text{Analog Output Voltage})$$

$$P = 10^{V-2} \text{ Pa}$$

3.12.2 Optional Analog Output of 1 to 8 V

In some applications a 0 V output is used to indicate that the Controller is OFF. To accommodate these situations a one volt offset is available as an alternative.

For this Alternate output format, a -0.0 indication produces 0.5 V output. A 10 V output means the gauge is unplugged or faulty.

If the output is adjusted to 1V at 10^{-4} Torr (10^{-2} Pa), the output equation for 1 to 8 V is:

$$P = 10^{V-5} \text{ Torr}$$

$$P = 10^{V-5} \text{ mbar}$$

$$P = 10^{V-3} \text{ Pa}$$

3.12.3 Optional Nonlinear Analog Output "S Curve"

In some applications a 0 to 9 V output similar to the Convectron Series 275 Controller output is desirable. To accommodate these situations, a third analog output option is available.

Note: A 10 Volt or greater output means the gauge cable is unplugged.

Use these equations with the coefficients listed in Table 3-4 to calculate pressure.

$$V_1 = V_0(454.67) \quad (V_0 = \text{Analog Output Voltage})$$

$$P = K_0 + K_1V_1 + K_2V_1^2 + K_3V_1^3 \text{ (Torr)}$$

Table 3-4 Converting Measured Voltage to Pressure

Segment #	Coefficients	Voltage Range
1	K ₀ = +0.000000E+00 K ₁ = +1.428571E-04 K ₂ = +2.551020E-07 K ₃ = +9.110787E-11	0 to 1.8457
2	K ₀ = -2.681040E-01 K ₁ = +9.758000E-04 K ₂ = -5.950000E-07 K ₃ = +3.750000E-10	1.8457 to 3.1641
3	K ₀ = +1.100000E+00 K ₁ = -1.675000E-03 K ₂ = +1.125000E-06 K ₃ = +7.414069E-21	3.1641 to 4.3945
4	K ₀ = -3.777930E+01 K ₁ = +5.495931E-02 K ₂ = -2.652588E-05 K ₃ = +4.526774E-09	4.3945 to 6.54785

Table 3-4 Converting Measured Voltage to Pressure

Segment #	Coefficients	Voltage Range
5	$K_0 = -7.184400E+03$ $K_1 = +7.117083E+00$ $K_2 = -2.354167E-03$ $K_3 = +2.604167E-07$	6.54785 to 7.3828
6	$K_0 = -5.439800E+04$ $K_1 = +4.990375E+01$ $K_2 = -1.528125E-02$ $K_3 = +1.562500E-06$	7.3828 to 7.6465
7	$K_0 = +1.811462E+06$ $K_1 = -1.511014E+03$ $K_2 = +4.196562E-01$ $K_3 = -3.880208E-05$	7.6465 to 7.9102
8	$K_0 = -2.417225E+05$ $K_1 = +1.919958E+02$ $K_2 = -5.106048E-02$ $K_3 = +4.554342E-06$	7.9102 to 9.

3.13 Analog Output Mode Programming

1. Press the UP or DOWN button and select "Setup Parameters" with the ENTER button.
2. Press the UP or DOWN button and select "Analog Out Mode" with the ENTER button.
3. The current mode will show in reverse video. Press the UP or DOWN button to select "I V/Decade, I-8V" or "I V/Decade, 0-7V" or "S Curve, 0-9V".
4. Press the ENTER button to save the mode.
5. Press the BACK button a few times or wait one minute to return to pressure display.

3.14 Process Control Setpoints & RS-232 or RS-485 Interface

Programming the process control setpoints is explained in *Chapter 4*.
Configuration of the RS-232 interface is explained in *Chapter 5*.
Configuration of the RS-485 interface is explained in *Chapter 6*.

Chapter 4 Process Control

The process control option provides a convenient method of organizing and establishing automatic control of vacuum system operations. Control is based on configuring pressure setpoints to activate relays in the Controller.

Two process control setpoints are available to provide control of other vacuum system equipment such as valves, pumps, heaters, alarms, and safety interlocking.

4.1 Process Control Setup

Before putting the Controller into operation, you must perform the following procedures:

1. Use the "Product Info" menu item to identify the process control options installed in your unit. (See *Product Information* on page 29.)
2. Install the Controller in accordance with the instructions in *Chapter 2*.
3. Use Table 4-1 to record the proposed activation and deactivation setpoints for each relay.

Table 4-1 Relay Setpoints

Relay	Activation setpoint (Pressure)	Deactivation setpoint (Pressure)
Relay 1		
Relay 2		

4. Develop a circuit schematic that specifies exactly how each piece of system hardware will connect to the Controller relays.
5. Attach a copy of the process control circuit diagram to this manual for future reference and troubleshooting.
6. Do not exceed the relay ratings listed below:
Relay Configuration: Normally Closed, Normally Open, Common (NC, NO, C).
Relay Contact Rating: 5 A, 250 VAC, or 30 Vdc, resistive load.
7. If you desire application assistance, contact a Granville-Phillips application engineer. See *Service Guidelines* on page 11 or *Customer Service* on page 99 for contact information.

Figure 4-1 Convectron Gauge, Output, and Power Connections

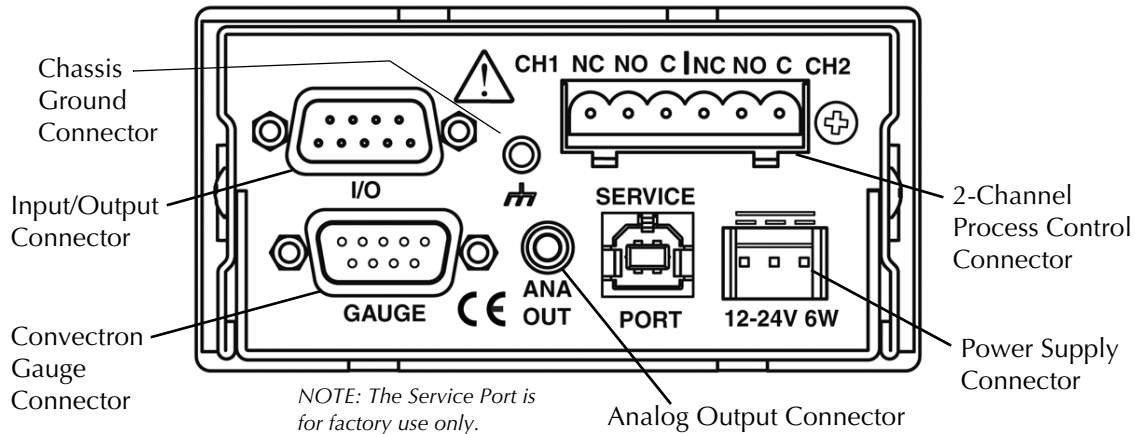

4.2 Connecting Process Control Relays

The process control connector, located on the rear panel of the Controller, is marked with letters identifying each pin. See *Connectors* on page 25.

A mating connector (Granville-Phillips part number 0167820) is supplied in the hardware kit.

1. Using a drawing of the process control output connector and the circuit schematics you have prepared, make a cable to connect the various system components to be controlled. Clearly label each lead to help prevent costly mistakes.
2. Connect the component end of the cable to the system component to be controlled. This is done with a small screwdriver and screw-post connections.
3. Plug the connector into the back of the 475 Controller.

4.3 Setpoint Display and Adjustment

1. On the front panel of the 475 Controller, press the UP or DOWN button to scroll to "Configure" and press the ENTER button.
2. Press the UP or DOWN button to select "Setpoint 1" or "Setpoint 2" and press the ENTER button.
3. Press the UP or DOWN button to select "Value", "Hysteresis", "Polarity", or "Relay" and press the ENTER button.

Value

1. The indicated setting will show in reverse video. Press the UP or DOWN button to select the desired setpoint.
2. Press the ENTER button to save the selection.
3. Press the BACK button a few times or wait one minute to return to pressure display.

Hysteresis

1. The indicated setting will show in reverse video. Press the UP or DOWN button to select the desired "Hysteresis" percentage.
2. Press the ENTER button to save the selection.
3. Press the BACK button a few times or wait one minute to return to pressure display.

Polarity

1. The indicated setpoint polarity setting will show in reverse video. Press the UP or DOWN button to select “Normal” or “Reverse”.
2. Press the ENTER button to save the selection.
3. Press the BACK button a few times or wait one minute to return to pressure display.

Relay

1. The indicated setpoint relay setting will show in reverse video. Press the UP or DOWN button to select “Enabled” or “Disabled”.
2. Press the ENTER button to save the selection.
3. Press the BACK button a few times or wait one minute to return to pressure display.

4.4 Process Control Tips

Relay actuation occurs when the pressure reading is greater than the setpoint for reverse polarity or less than the setpoint for normal polarity. A default 10% hysteresis is programmed into each setpoint for returning pressures.

Table 4-2 exemplifies this function using an assumed setpoint pressure. The example also assumes that the polarity is set to activate the relay when pressure falls below the setpoint.

Table 4-2 Setpoint Normal Polarity (– minus)

Setpoint Pressure	Pressure Change	Relay Transition Pressure
6.30×10^{-2}	Falling	$< 6.30 \times 10^{-2}$
6.30×10^{-2}	Rising	Releases at $6.30 \times 10^{-2} + 10\% = 6.93 \times 10^{-2}$

Table 4-3 Setpoint Reverse Polarity (+ plus)

Setpoint Pressure	Pressure Change	Relay Transition Pressure
6.30×10^{-2}	Rising	$> 6.30 \times 10^{-2}$
6.30×10^{-2}	Falling	Releases at $6.30 \times 10^{-2} - 10\% = 5.67 \times 10^{-2}$

4.5 Process Control Factory Default Settings

Table 4-4 lists the factory default the settings for the process control relays.

Table 4-4 Process Control Relay Default Settings

Feature	Default Setting
Setpoint	1E-4
Relay Polarity	Activation below pressure setpoint Normal Polarity / minus (–)
Returning Pressure Hysteresis	10%

4.6 Process Control Relay Trip Points

The 475 Controller is shipped from the factory with the trip point relays set to a pressure of 1.00E-4 Torr. The relays need to be adjusted for your application.

The trip point may be set from 1×10^{-4} Torr to 999 Torr. The pressure measurement unit restricts the trip points at the extremes of the measurement range. A built-in default hysteresis of 10% prevents oscillation around the trip point.

In the default mode, relays activate with decreasing pressure and deactivate at a 10% higher pressure than the activation pressure, as illustrated in Figure 4-2.

You can reverse relay polarity, so relays activate with increasing pressure and deactivate at a lower pressure than the activation pressure.

Figure 4-2 Process Control Relay Behavior

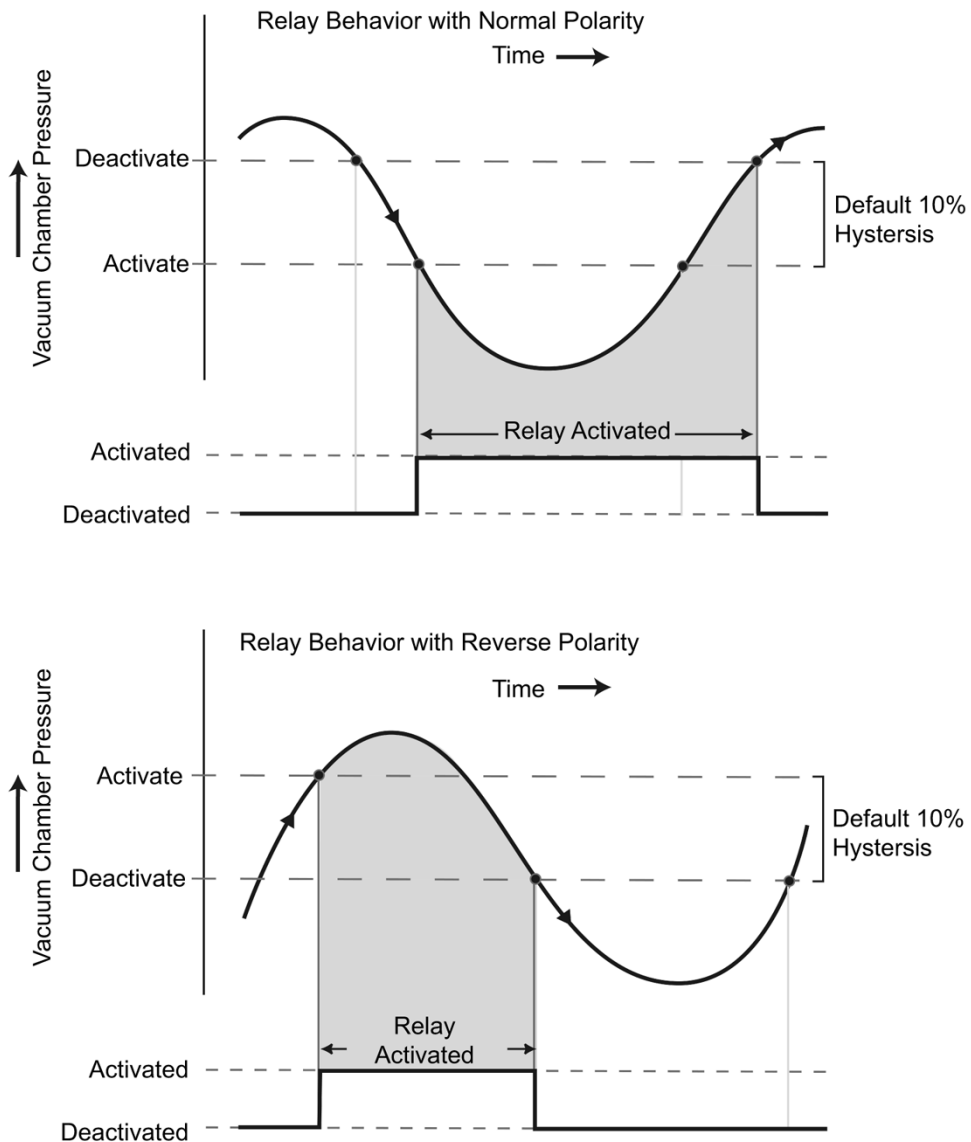

Chapter 5 RS-232 Interface

5.1 RS-232 Theory of Operation for the 475 Controller

The RS-232 interface option permits data output to, and Convectron Gauge control by, a host computer. Output control is by a command-response mechanism and a hardwire control line between RTS (Request To Send) and CTS (Clear To Send). If you have this Controller option, configure it to your system requirements as directed in this chapter.

NOTE: CTS and RTS are used only if handshaking is enabled.

The DSR (Data Set Ready) line is set 'true' upon power up to indicate it is on-line and is ready to receive data. When the Controller receives a start bit on the received data line, it will input and buffer a character. The Controller will continue to receive and buffer characters until the terminator (carriage return) is received.

Upon receiving the terminator, the Controller will assert the RTS line as a holdoff to prevent the host computer from attempting to transmit further data until the message just received has been decoded and a reply has been output.

During output of the reply, the incoming handshake line CTS is tested prior to beginning transmission of each character. The Controller will wait until CTS is true before beginning transmission of a character, and will not test them again until ready to begin transmitting the next character.

After transmitting the terminator, the Controller will negate RTS and wait for the next incoming message.

5.2 Connecting the RS-232 Computer Interface

Figure 5-1 Control Unit Rear Panel Showing RS-232 (I/O Output) Connector

See I/O (RS-232) 9-Pin Connector (pins) on page 25

NOTE: The Service Port is for factory use only.

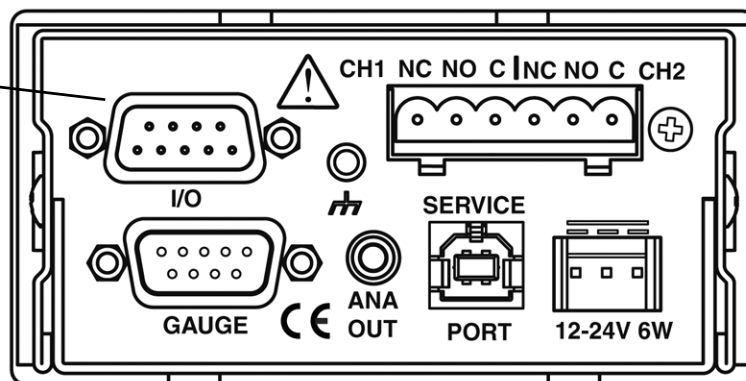

A mating 9-pin D type connector is supplied in the hardware kit. Use shielded cable to minimize electromagnetic radiation or susceptibility. Ground the shield to the metal connector shell or to Pin 5. Do not connect the shield to Pin 7.

Table 5-1 RS-232 Connector Pin Assignments

Signal	Pin Number	Direction
Signal Ground	5	–
Transmitted Data (TXD)	2	To Computer
Received Data (RXD)	3	To Controller
Data Set Ready (DSR)	6	To Computer
Clear To Send (CTS)	7	To Controller
Request To Send (RTS)	8	To Computer
Not Used	1 and 4	

Table 5-2 Computer Cable Pin Assignments for a 9 Pin Connector

Controller Connector	PC Connector	Cable Pinout	Signal at Computer	Signal at 475 Controller
DB9S	DE9P	DE9S (DB9P)		
2	2	2 (3)	RXD	TXD
3	3	3 (2)	TXD	RXD
5	5	5 (1)*	Signal Ground	Signal Ground
8	8	8 (5)	CTS	RTS
7	7	7 (4)	RTS	CTS
6	6	6 (6)	DSR	DSR

* Use metal connector shell to provide shield wire ground.

5.3 RS-232 Handshake

Normal handshake control can be accomplished using the command-response mechanism, and a hard-wired handshake by using the RTS/CTS connection as outlined in Table 5-3. This RTS/CTS connection has to be enabled via a separate function.

Table 5-3 Handshaking Outputs from Controller

Line	Pin	Description	Factory Setting
RTS	8	Output from Controller to be tied to the computer's CTS input for hardware handshake control	Always high
CTS (input)	7	Input to Controller. Used to sense the RTS line of the computer before sending data	No control of data output
DSR (output)	6	Set high when the Controller is turned ON	Not applicable

Table 5-4 RTS/CTS Handshake Display Readouts

Display Readout	Byte Format
"Handshake disabled"	Disable RTS/CTS handshake
"Handshake enabled"	Enable RTS/CTS handshake

When the handshake is enabled:

1. Upon receiving the terminator, the Controller will assert the RTS line as a holdoff to prevent the host computer from attempting to transmit further data until the message just received has been parsed and a reply has been sent.
2. During the transmission of the reply, the CTS incoming handshake line is tested prior to transmission of each character. The Controller will wait until CTS is true before beginning transmission of a character, and will not test it again until ready to begin transmitting the next character.
3. After transmitting the terminator, the Controller will negate RTS and wait for the next incoming message.

To summarize:

- **CTS (Clear To Send):** This is sent by the computer to indicate that the Controller may transmit the next byte in its message. As shipped from the factory, this line is disabled. The Controller will automatically assume the host is ready to receive.
- **RTS (Request to Send):** This is negated by the Controller at power-up. The RTS is asserted by the Controller upon receipt of a message terminator. RTS is negated after transmitting the terminator of the Controller's response to that message.

5.4 Command-Response Timing

The timing diagram illustrated in Figure 5-2 depicts the time it takes for a command to be transmitted to the 475 Controller, processed, a response sent back.

Figure 5-2 Command Response Timing Diagram

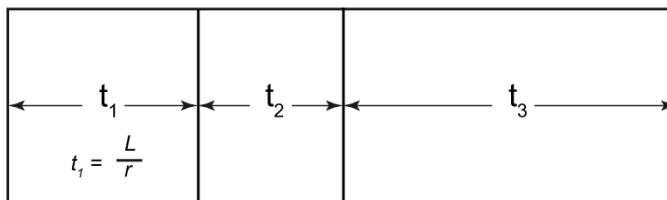

t_1 - Duration of the transmission of the command from the Host to the 475 Controller. This is dependent on the Length (L) of the command in bits and the baud rate (r).

$$t_1 = L/r$$

t_2 - Duration for the 475 Controller to process the command. This is dependent on the command but is typically less than 20 milliseconds. Commands to save/restore user profiles (UC) can take up to 75 milliseconds. Diagnostic commands (DT) can take up to 500 milliseconds.

t_3 - Duration of the transmission of the response from the 475 Controller to the Host. This is dependent on the length of the response in bits (L) and the baud rate (r).

$$t_3 = L/r$$

5.5 Preparing the RS-232 Computer Interface

Check the user's manual for the host computer to be sure the protocol used is compatible with that established via the configuration of the RS-232 Controller.

Communication with the control unit is via the transmission of ASCII strings. A message consists of a command and a command modifier, followed by a terminator. The message may contain leading spaces, and the command and modifier may optionally be separated by spaces or commas. No spaces may appear within the command or the modifier, only between them.

The terminator expected by the control unit is an ASCII carriage return, the $0D_{\text{hex}}$ character, denoted in this instruction manual by the \downarrow symbol. The line feed is optional, and messages terminated with only the carriage return will be accepted. Note that the LF (line feed) terminator ($0A_{\text{hex}}$) may be appended automatically by the host computer's interface software to the message string supplied by the user. This line feed will be ignored.

If extra characters are found in the message after it has been successfully interpreted but before the terminator, they will be ignored. Characters can be upper- or lower-case. All messages to the Controller will receive a reply consisting of an ASCII string of upper-case letters terminated with \downarrow . Pressures will be returned in the format X.XXE±XX.

5.6 RS-232 Command Syntax

A command from the host must include data and a terminator (data)(terminator). The terminator is an ASCII carriage return, the 0D_{hex} character, denoted here by the ↵ symbol.

The data field is explained in the command descriptions. All alpha characters can be upper or lower case.

All data fields responses will contain up to 9 upper case alphanumeric characters. A response of “SYNTAX ERR” is caused by an incorrect character string from the host. A response of “F P ERR” is displayed when a function is set via the front panel on the 475 Controller (See Chapter 3).

Table 5-5 List of RS-232 User Commands

Command	Description	Page	RST to Change
AO	Set analog output mode	66	
AOO	Get/Set analog output offset	66	
CA	Get calibration status	66	
DT	Perform diagnostic tests	67	
FAC	Set calibration to factory defaults	67	
GS	Modify gas species settings	68	
HA	Set handshaking	68	Yes
KP	Enable/Disable keypad	69	
LPF	Enable/Disable LPF (Low-Pass Filter)	69	
PC	Get or set process control setpoint value	69	
PCE	Enable/Disable relays	69	
PCH	Get or set process control setpoint hysteresis	70	
PCP	Get or set process control setpoint polarity	70	
PD	Modify programmable delay settings	70	
RD	Read the pressure	71	
RST	Reset the Controller	71	
RU	Read units of pressure	71	
SB	Set the baud rate	72	Yes
SN	Get the serial number	72	
SPE	Set parity and data bits (Even)	72	Yes
SPN	Set parity and data bits (None)	72	Yes
SPO	Set parity and data bits (Odd)	72	Yes
ST	Get/Set Convectron Gauge sensor type	72	
SU	Set the units of pressure	73	
TS	Set span	73	
TZ	Set zero	73	
UC	Restore/save user configuration.	74	
VC	Void NIST calibration	74	
VER	Read code version	74	
	RS-232 Troubleshooting	75	
	RS-232 Error Messages	75	

NOTE: See Section 5.7.1 for a list of common error messages.

AO	Analog Output	Definition:	Get/Set the analog output mode.
		Modifiers:	1, 2, or 3
		Response:	PROGM OK↵
		Example:	
		From host computer:	AO1↵ (or AO2, or AO3)
		From 475 Controller:	PROGM OK↵
			<ul style="list-style-type: none">• Command AO1 sets the analog output to log 0-7V.• Command AO2 sets the analog output to log 1-8V.• Command AO3 sets the analog output to log 0-9V S-curve.
			NOTE: The AO3 command applies ONLY when N2 is selected.
AOO	Analog Output Offset	Definition:	Get/Set analog output offset voltage.
		Modifiers:	0 to 0.5
		Response:	PROGM OK↵ Set analog output offset voltage.
		Example:	
		From host computer:	AOO 0.2↵
		From 475 Controller:	PROGM OK↵ Sets analog output offset voltage by 0.2V.
CA	Read NIST Traceability Calibration Status	Check status of NIST Traceable System Calibration:	
		Definition:	Calibration status.
		Modifiers:	None.
		Possible Responses:	CAL CERT↵ NIST traceable calibration is valid. CAL VOID↵ NIST traceable calibration is void.
			See the VC command to void the NIST calibration.

DT Diagnostics Test Definition: Perform diagnostics tests on A/D and analog out.
 Modifiers: C, CS, CE, CP, CV, CD
 A, A#, AD
 Response: See the examples, below.
 Examples:

Command Root	From Host Computer	From 475 Controller
DT	DT↵	PASS↵ Run auto test on A/D and analog output.
		FAIL↵ Both functions failed.
		AD FAIL↵ A/D failed.
		AO FAIL↵ Analog output failed.
DTC	DTC↵	PASS↵ Run auto test on A/D.
		FAIL↵ A/D failed.
	DTCS↵	1↵ Simulator enabled.
		0↵ Simulator disabled.
	DTCD↵	PROGM OK↵ Disable simulator.
	DTCE↵	PROGM OK↵ Enable simulator.
	DTCP1.00E-3↵	PROGM OK↵ Set simulator pressure.
	DTCV5.534↵	PROGM OK↵ Set simulator bridge voltage.
DTA	DTA↵	PASS↵ Run auto test on analog output.
		FAIL↵ Analog output test failed.
	DTA5.00↵	PROGM OK↵ Set analog output voltage.
	DTAD↵	PROGM OK↵ Resume pressure reporting to analog output.

FAC Reset User Calibration to Factory Defaults Definition: Set to factory defaults.
 Modifiers: None.
 Response: PROGM OK↵
 Example: From host computer: FAC↵
 From 475 Controller: PROGM OK↵
 FAC will cause default VAC and ATM parameters to be programmed to the factory default settings.

GS Gas Species

Definition: Get/Set gas species commands. See *Gas Species* on page 35 for a detailed explanation.

Modifiers: N₂ (Nitrogen), AR (Argon), HE (Helium), CO₂ (Carbon Dioxide), O₂ (Oxygen) FS (Factory Specified), CF (Correction Factor).

Response: See the examples, below.

Examples:

Command Root	From Host Computer	From 475 Controller
GS	GS↓	N ₂ ↓ AR↓ HE↓ CO ₂ ↓ O ₂ ↓ FS↓, or CF↓ (FS = Factory Specified curve / CF = Correction Factor)
	GSN2↓ (or AR, HE, CO ₂ , O ₂ , FS, CF)	PROGM OK↓ Set the gas species to the gas being used.
		INVALID↓ The system is NIST calibrated.
	GSFS↓	INVALID↓ The data in memory is not valid or the system is NIST calibrated.
	GSCF↓	1.5↓ The correction factor being used. (CF of 1.5 in this example)
	GSCF 1.0↓	PROGM OK↓ Set the gas species to a new correction factor (0.1 to 1.5 in 0.1 increments) (this example: 1.0 CF).
	GSCF 1.0, 200↓	PROGM OK↓ Set the gas species to a new correction factor, and maximum pressure (0.1 to 1.5 CF and 1mTorr to 999 Torr) (this example: 1.0 CF and 200 Torr).
	GSCFP↓	1.00E+2↓ Get current max pressure setting (this example: 100 Torr).
	GSCFP 150↓	PROGM OK↓ Set the gas species to the correction factor, and maximum pressure (1mTorr to 999 Torr) (this example: 150 Torr).

HA Enable/Disable RTS/CTS Handshake

Definition: Enables or disables RTS/CTS handshake.

Modifiers: 1 or 0 (1 = enable, 0 = disable).

Response: PROGM OK↓

Example: From host computer: HA1↓

From 475 Controller: PROGM OK↓

KP	Keypad	Definition:	Get the keypad status, or Enable/Disable the keypad on the 475 Controller.
		Modifiers:	1 or 0 (1 = enable, 0 = disable).
		Response:	PROGM OK↵
		Examples:	From host computer: KP↵ Get the Keypad status (Enabled or Disabled) From 475 Controller: 0↵ or 1↵ From host computer: KP1↵ Enable keypad (KP0↵ = Disable keypad) From 475 Controller: PROGM OK↵
LPF	Low-Pass Filter	Definition:	Enables another order of low-pass filtering for the pressure reading.
		Modifiers:	1 or 0 (1 = enable, 0 = disable).
		Response:	PROGM OK↵
		Example:	From host computer: LPF1↵ Enable Low-Pass Filter (or LPF0↵ Disable Low-Pass Filter) From 475 Controller: PROGM OK↵
PC	Set Setpoint Pressure	Definition:	Setpoint pressure setting
		Modifiers:	1 or 2; X.XXE±XX (pressure range is .1 mTorr to 999 Torr).
		Response:	X.XXE±XX↵ (pressure)
		Example:	From host computer: PC 1 4.35E-02↵ From 475 Controller: PROGM OK↵
PCE	Relays	Definition:	Enable/Disable relays.
		Modifiers:	1 or 0 (1 = enable, 0 = disable).
		Response:	PROGM OK↵
		Examples:	

Command Root	From Host Computer	From 475 Controller
PCE	PCE↵ Get relay status.	PROGM OK↵
	PCE01↵ Enable Relay 1, disable relay 2	PROGM OK↵
	PCE10↵ Enable Relay 2, disable relay 1	PROGM OK↵
	PCE11↵ Enable both relays.	PROGM OK↵
	PCE00↵ Disable both relays.	PROGM OK↵

If a relay is disabled, it must be re-enabled it to make it operable. The previous relay settings are still applicable and can be recalled.

Enabling or disabling a relay that doesn't exist results in a syntax error.

PCH Process Control Setpoint Hysteresis

Definition: Set the process control setpoint hysteresis.
 Modifiers: 1, or 2 (for setpoint 1 or 2).
 Possible Responses: PROGM OK↵
 RANGE ERR↵ The value entered is <5 or >1000.
 Examples: From computer: PCH1↵ Get setpoint 1 hysteresis.
 From 475 Controller: 200↵ Setpoint 1 hysteresis is 200%
 From host computer: PCH2 100↵ Set setpoint 2 hysteresis.
 From 475 Controller: PROGM OK↵ The setpoint hysteresis is 100%.

PCP Set Relay Polarity

Definition: Set the polarity of the relay activation.
 (-) relay activation = < the current pressure setting.
 (+) relay activation = > the current pressure setting.
 Modifiers: 1 or 2; + or -
 Possible Responses: PROGM OK↵
 INVALID↵ Invalid if the option is not installed.
 Examples: From host computer: PCP1 +↵
 From 475 Controller: PROGM OK↵

PD Set Delay

Definition: Pressure filtering response delay.
 Modifiers: 0 to 200 ms (Modifier values are rounded to the nearest 10 ms)
 Possible Responses: PROGM OK↵
 RANGE ER↵ Modifier value is out of range

Examples:

Command Root	From Host Computer	From 475 Controller
PD	PD↵ Get (show) the current delay setting.	150↵
	PD10↵ Set 10 ms delay.	PROGM OK↵
	PD150↵ Set 150 ms delay.	PROGM OK↵

Response Delay provides a delayed readout of the indicated pressure. The delay time can be set in 10 millisecond increments for the 475 Controller to display a pressure reading. Also, see LPF.

RD	Read Pressure	<p>Definition: Read Convectron Gauge pressure response.</p> <p>Modifiers: None.</p> <p>Possible Responses: 9.34E-02↵ Pressure value OPN SNSR↵ Defective transducer SNSR UNP↵ Sensor is unplugged SNSR UDP↵ Under pressure, limit related to TZ command SNSR OVP↵ Pressure higher than 999 Torr, or gases other than the selected gas type in the system are causing the indicated pressure to be above 999 Torr. (Atmosphere pressure of helium will cause this response.)</p> <p>Example: From host computer: RD↵ From 475 Controller: 9.34E-02↵</p> <p>ASCII string representing pressure in scientific notation. Three significant digits except in 10⁻³ Torr range with 2 significant digits and a zero filler, 10⁻⁴ Torr range with 1 significant digit with 2 zero fillers.</p> <p>While at vacuum, the output should be 0.00E-04 (= 0.0 mTorr displayed.) Output 0.00E+00 (= -0.0 mTorr displayed) occurs when the transducer voltage at vacuum has drifted lower than the Convectron Gauge can sense. The response to RD received at vacuum will fluctuate under normal operation, but if the SNSR UDP error appears consistently, calibration may be required. See <i>TZ Calibrate at Vacuum</i> on page 74 and Section 3.11.</p>
RST	Reset Controller	<p>Definition: Reset Controller.</p> <p>Modifiers: None.</p> <p>Response: None.</p> <p>Example: From host computer: RST↵ From 475 Controller: None</p> <p>The RST command will reset the Controller as if the power had been cycled. The RST command has no response but resets the Controller operation. Communication is re-enabled in approximately 2 seconds.</p>
RU	Read Pressure Unit	<p>Definition: Identifies the selected units of pressure.</p> <p>Modifiers: Torr, mbar, Pascal.</p> <p>Response: None.</p> <p>Example: From host computer: RU↵ From 475 Controller: TORR ↵</p> <p>See SU (Set Unit of Pressure) to change the displayed unit of measurement to another.</p>

SB	Set Baud Rate	Definition: Set the baud rate Modifiers: 1200, 2400, 4800, 9600, 14400, 19200, 28800, 38400. Response: PROGM OK↵ Example: From host computer: SB19200↵ From 475 Controller: PROGM OK↵
		The baud rate needs to be set at a valid rate, i.e., 1200, 2400, 4800, 9600, 19200, 38400. If the rate is set to an odd value, for example 2234, the Controller will stay at the present rate and respond with SYNTAX ERR. Cycle power or send RST after sending this command to enable changes See <i>Command-Response Timing</i> on page 64.
SN	Serial Number	Definition: Get the serial number of the 475 Controller. Modifiers: None. Response: 475A1234↵ Example: From host computer: SN↵ From 475 Controller: 475A1234↵
		The serial number can be up to 16 characters long.
SPE	Set Parity to 7 Bits/Even Parity Check	Definition: Set bits/parity to 7 bits/even, 1 stop bit. Modifiers: None. Response: PROGM OK↵ Example: From host computer: SPE↵ From 475 Controller: PROGM OK↵
		Cycle power or send RST after sending this command to enable changes.
SPN	Set Parity to 8 Bits/No Parity Check	Definition: Set bits/parity to 8 bits/none, 1 stop bit. (Factory default) Modifiers: None. Response: PROGM OK↵ Example: From host computer: SPN↵ From 475 Controller: PROGM OK↵
		Cycle power or send RST after sending this command to enable changes.
SPO	Set Parity to 7 Bits/Odd Parity Check	Definition: Set bits/parity to 7 bits/odd, 1 stop bit. Modifiers: None. Response: PROGM OK↵ Example: From host computer: SPO↵ From 475 Controller: PROGM OK↵
		Cycle power or send RST after sending this command to enable changes.
ST	Get/Set Convectron Gauge Sensor Type	Definition: Get/Set the gauge sensor type (Gold-plated tungsten or Platinum) Modifiers: Au, Pt

		Possible Responses:	AU↓ (or PT↓) or PROGM OK↓
		Examples:	From host computer: ST↓ get currently selected sensor type From 475 Controller: AU↓ current sensor type is gold-plated tungsten From host computer: ST PT↓ change sensor type to Platinum From 475 Controller: PROGM OK↓
SU	Set Unit of Pressure	Definition:	Selects and sets the units of pressure measurement.
		Modifiers:	T, M, or P (Torr, mbar, or pascal).
		Response:	PROGM OK↓
		Example:	From host computer: SUT↓ From 475 Controller: PROGM OK↓
TS	Set Span	Definition:	Set span (typically at atmospheric pressure).
		Modifiers:	Pressure value above 399 Torr (for N ₂).
		Possible Responses:	PROGM OK↓ GAIN LIM↓ Gain programmed at limit. Readout will be the pressure at maximum TS setting. OPN SNSR↓ Sensor defect, no change in programming. See Section 8.5. SNSR UNP↓ Sensor unplugged, no change in programming. RANGE ER↓ Command error. TS must be set above 399 Torr, and system pressure must be above 399 Torr. INVALID↓ System is calibrated and locked.
		Example:	From host computer: TS 7.60E+02↓ From 475 Controller: PROGM OK↓
			Do this only at pressures above 399 Torr; The Controller will respond with RANGE ER if done below 399 Torr or near vacuum. The change occurs as soon as the function is performed. If the Controller is NIST calibrated, the response for this command will be INVALID. See Section 3.11.5.
TZ	Set Zero	Definition:	Set zero.
		Modifiers:	0 or pressure below 1 x 10 ⁻¹ Torr in scientific notation.
		Possible Responses:	PROGM OK↓ OFST LIM↓ Offset programmed at limit. Readout will be the pressure at maximum TZ setting. OPN SNSR↓ Sensor defect. No change in programming. See Section 8.5. SNSR UNP↓ Sensor unplugged. No change in programming.

RANGE ER↓ Command error. TZ must be set below 1×10^{-1} Torr, and system pressure must be below 1×10^{-1} Torr.

INVALID↓ System is NIST calibrated and locked.

Examples:

From host computer: TZ0↓

From 475 Controller: PROGM OK↓

From host computer: TZ1 . 00E-02↓

From 475 Controller: PROGM OK↓

Do this only at pressures below 1×10^{-1} Torr. The response will be a RANGE ER if done near atmosphere. The change occurs as soon as the function is performed.

UC User Configurations

Definition: Save a program configuration or restore a previously saved configuration.

Modifiers: S (Save), R (Restore) or F (Factory) / 1, 2, or 3.

Response: PROGM OK↓

Examples:

From host computer: UCS1↓

From 475 Controller: PROGM OK↓ Save the settings to the specified slot (#1 in this example).

From host computer: UCR3↓

From 475 Controller: PROGM OK↓ Restore the settings from the specified slot (#3 in this example).

“Save Configuration” allows the user to save up to three configurations in addition to the factory default configuration. Three different user settings can be programmed and saved. Each user setting will include the unique setpoint parameters, unit of measurement, analog output setting, computer interface parameters, atmosphere and vacuum calibrations, gas species setting, and display options.

“Restore Configuration” allows the user to switch to any of the four saved configurations. Four different configurations (one factory default and three user-set configurations) can be programmed and saved. Each user setting will include unique setpoint parameters, unit of measure, analog output setting, computer interface parameters, atmosphere and vacuum calibrations, gas species setting, and display options. Initial user settings are programmed to the factory defaults.

VC Void NIST Traceability Calibration

For NIST Traceable System Calibration:

Definition: Void calibration.

Modifiers: None.

Response: PROGM OK↓ (Calibration functions and gas settings are now unlocked.) GS, ST, TS, TZ, and FAC commands will now work.

VER Read Version

Definition: Read code version.

Modifiers: None.

Response: Code version (alpha-numeric).

Example: From host computer: VER↓

From 475 Controller: 030409-C↵

5.7 RS-232 Troubleshooting

Because the RS-232 standard is found in various configurations, check the following configuration options.

1. Check the RS-232 setting via the front panel of the 475 Controller. Be sure the baud rate, character format and framing, and interface protocol are matched to the requirements of your host computer or terminal. There may be several mismatched parameters. Check the handshaking to verify that the host computer and the 475 Controller settings match.
2. Check the interface wiring. The pin designations for the RS-232 connector are shown in Section 5.2 on page 61. Note that the “received” and “transmitted” data lines are defined as seen by the Controller. Many companies supply “null modems” or switch boxes for the purpose of re-configuring the control lines for particular applications. A standard 9-pin extension cable with a gender changer will work for many applications.
3. Check the command syntax. Be sure the strings you send to the Controller are in accordance with the syntax defined in Section 5.6 on page 65.

5.7.1 RS-232 Error Messages

If an error is found in the incoming message, the following messages will be returned in place of the normal response.

No Response or garbled output

- Baud rate incorrect
- Character length incorrect or stop bit(s) incorrect
- Bad cable or connection
- Command does not include 0D_{hex} (↵) terminator character

OVERRUN ERROR

Returned if the incoming message overflows the Controller's buffer. This may indicate a flaw in the host software.

PARITY ERROR

Returned if the parity of a byte in the incoming message does not match that programmed by the RS-232 setting in the 475 Controller.

SYNTAX ERROR

Returned if the message fails to parse as a valid Controller command.

F P ERROR

Returned if a function is being controlled via the front panel inputs on the 475 Controller.

INVALID

Function is not valid or possible at this time.

Chapter 6 RS-485 Interface

6.1 RS-485/422 Computer Interface Setup

This option permits data output to, and operational control by, a host computer. Output control is by a command-response mechanism. If you have this module in your unit, configure it to your system requirements as directed in this chapter.

A variety of baud rates and byte framing options are available.

6.2 RS-485/422 Computer Interface Factory Default Settings

The following table lists the default settings for the RS-485/422 Computer Interface option.

Table 6-1 RS-485 Default Settings

Feature	Default Setting
RS-485/422	
Baud Rate	19200 baud
Byte Format	8N1 - 8 data bits, No parity; 1 stop bit
Bus Type	4-Wire mode
Transceiver Mode	Fast

6.3 RS-485/422 Computer Interface Settings

6.3.1 Baud Rate

The baud rate is the speed at which data is transmitted between the host and the slave. The host and the slave need to be configured for the same baud rate for messages to be interpreted correctly.

The 475 Controller offers standard rates from 1200 bps to 38400 bps. The baud rate can be changed through the SB Command or through the front panel (Configure > RS485 Parameters > Baud Rate).

Table 6-2 Baud Rates

Selectable Baud Rates
1200
2400
4800
9600
14400
19200
28800
38400

6.3.2 Data Format

The Data Format setting affects how a message is interpreted by the host and the slave. Using this setting, the user is able to choose the number of data bits and the parity. Parity checking can provide some protection from transmission errors. The host and the slave need to be configured for the same Data Format.

The 475 offers three different Data Formats -

- "8N1" - 8 Data Bits, No Parity, 1 Stop Bit
- "7E1" - 7 Data Bits, Even Parity, 1 Stop Bit

- ""7O1" - 7 Data Bits, Odd Parity, 1 Stop Bit

These formats can be selected through the "SPN", "SPE", "SPO" commands and the front panel (Configure > RS485 Parameters > Data Format).

6.3.3 Address

The 475 uses an addressing system since more than one 475 can be on the same bus. The address is an integer between zero and sixty-four represented as a two-digit hex string (Decimal address 10 is "0A"). The host uses this address to send a message to a particular 475. The address can be changed by the "SA" command or by the front panel (Configure > RS485 Parameters > Address).

6.3.4 Bus Type

The 475 is able to communicate on a physical bus configuration of two-wires or four-wires. See Section 6.4. The Bus Type setting allows the user to configure the 475 for each possibility. This can be changed through the "SC" command or through the front panel (Configure > RS485 Parameters > RS485 Bus Type).

6.3.5 Transceiver Mode

To support legacy transceivers, the user can choose between a "fast" and "slow" transceiver mode. This adjusts the delay between when the 475 finishes processing a command and when it starts to transmit a response.

Some legacy transceivers can take several milliseconds to switch the driver to high-impedance, allowing the driver in the 475 to properly transmit on the bus. For these transceivers, the user should choose the "slow" mode, which allows approximately fifteen milliseconds for the legacy transceiver on the bus to switch. In contrast, the "fast" mode allows approximately two milliseconds.

The transceiver mode setting can be changed through the "SXVR" command or through the front panel (Configure > RS485 Parameters > Xcvr mode).

6.4 RS-485/422 Physical Configurations

The RS-485 Computer Interface option supports the following balanced transmission line configurations:

- RS-422 4-wire (default), separate RX/TX lines
- RS-485 2-wire (optional), common RX/TX lines
- RS485 4-wire (default), separate RX/TX lines

First, some terms need to be defined: point-to-point, multi-drop, and multi-point. For this discussion, a point-to-point configuration is a signal transmitter and single receiver on a twisted pair wire. A multi-drop configuration is a single transmitter and multiple receivers sharing a twisted pair wire. A multi-point configuration has multiple transmitters and one or more receivers sharing a twisted pair wire.

1. RS-422 4-wire (default)

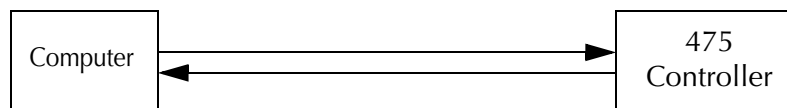

In this example, the 475 Controller is receiving over one pair of wires in a point-to-point configuration and transmitting over a second pair of wires in another point-to-point configuration.

2. RS-485 2-wire (optional)

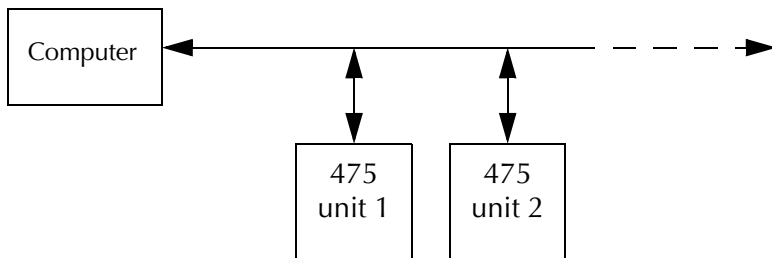

In this example, multiple 475 Controllers are transmitting and receiving over one pair of wires in a multi-point configuration.

3. RS-485 4-wire (default)

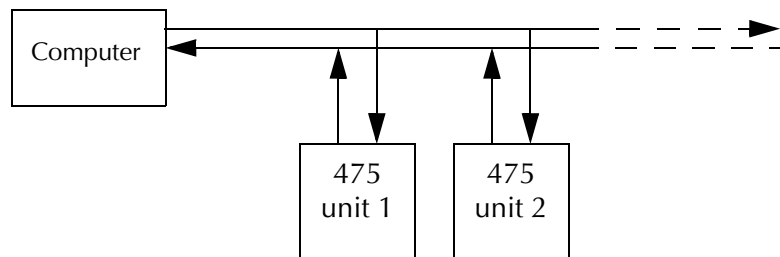

In this example, multiple 475 Controllers are transmitting over one pair of wires in a multi-point configuration and receiving over a second pair of wires in a multi-drop configuration.

Line Termination

For best signal quality, transmission line termination resistors should be used. The location of termination resistors depends on the configuration. Ideally, for point-to-point and multi-drop twisted pair wires, a single termination resistor should be added at the point on the communications line furthest from the driver sending the signal. For multi-point twisted pair wires, two termination resistors should be used - one at each of the farthest ends of the twisted pair cable. For example: one in parallel with the computer transmitter output and the other in parallel with the farthest 475 Controller's transmitter output. The value of the termination resistance should be close to the specified characteristic impedance of the cable.

No more than two terminations should be placed in any system that does not use repeaters. A daisy-chain topology has advantages for termination; the furthest ends of the network are relatively simple to determine. Complex network topologies, such as star and tree, make it difficult to determine where the extremities of the network are and, hence, the best location for termination.

6.4.1 Connecting the RS-485/422 Computer Interface

Figure 6-1 475 Controller Rear Panel Showing RS-485/422 Connector

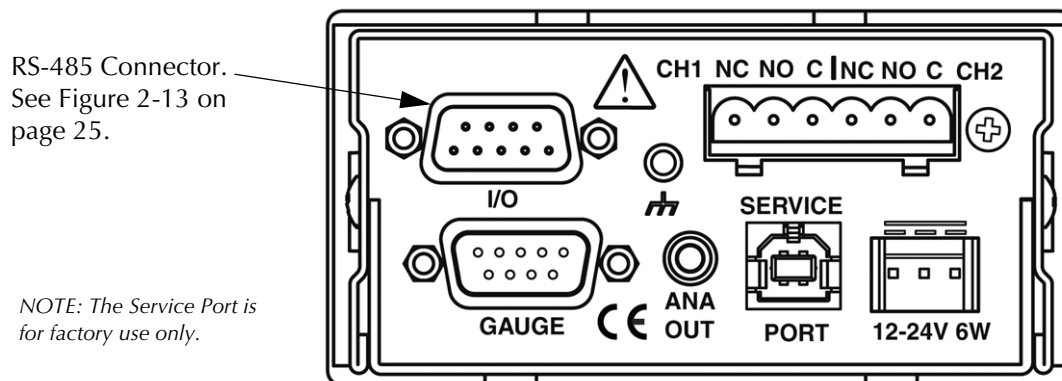

This factory or field installed option produces the signals shown in Table 6-3.

A mating 9-pin D type connector is supplied in the hardware kit. Use shielded cable to minimize electromagnetic radiation or susceptibility. Ground the shield to the metal connector shell.

Table 6-3 RS-485/422 Connector Pin Assignments, 4-wire

Signal	Pin Number	Direction
+ TX	4	To computer
Ground	3	N/A
- TX	5	To computer
+ RX	8	To 475
- RX	9	To 475

Table 6-4 RS-485/422 Connector Pin Assignments, 2-wire

Signal	Pin Number	Direction
Ground	3	N/A
+ RX and + TX	8	To 475 / To computer
- RX and - TX	9	To 475 / To computer

NOTE: See Section 2.8 in Chapter 2.

Long Cable Operation

Maximum cable length = 4,000 feet. Maximum number of devices = 32.

A common ground wire should be connected to all units for long cable runs.

Verify that the host computer's communication settings (baud rate, byte format, etc.) are the same as the 475 Controller. See Section 6.3 and Table 6-1.

6.5 Communications Protocol

The 475 Controller uses a command-response half-duplex protocol. If the 475 Controller recognizes received data as a valid command, it will check the command string address and compare with its own. If the addresses match, the 475 Controller will process the command and then respond. Half-duplex communications are supported. In all configurations, only one twisted pair will have data transmissions in one direction at any time.

Communication with the Control Unit is via ASCII strings. A message consists of a start character, an address, a command, a command modifier, and a terminator. The message may contain leading spaces, and the command and modifier may optionally be separated by spaces or commas. No spaces may appear within the command or the modifier, only between them.

The terminator expected by the Control Unit is an ASCII carriage-return, denoted here by CR (↵). The line-feed is optional, and messages terminated with only the carriage-return will be accepted. Note that the LF terminator is sometimes appended automatically by the host computer's interface software to the message string supplied by the user.

If extra characters are found in the message after it has been successfully interpreted but before the terminator has been received, they will be ignored. Characters can be upper- or lower-case. All messages to the 475 will receive a reply, consisting of an ASCII string of upper-case letters terminated with CR. Pressures will be returned in the format X.XXE±XX.

6.6 RS-485/422 Command Syntax

The message from the host must include a start character, address, command, and a terminator.

The start character is "#".

The terminator is "↵" (carriage return).

The address is two ASCII digits representing the Hex address of the module. This address will also be displayed on the front panel of the 475 Controller in a hex format. (See Table 3-2 and Section 3.5.3 to see the displayed address on the front panel of the 475 Controller.)

The command field is explained in the command descriptions. All alpha characters can be upper or lower case.

6.7 RS-485/422 Response Syntax

The response from the 475 includes a start character, address, data, and a terminator. The start character is "*" or "?", the terminator is "↵" (carriage return), and the address is a two ASCII digit hex representation of where the response is from. All data field responses contain up to 9 upper-case alphanumeric characters. A response of ?01 SYNTAX ER↵ is caused by an incorrect character string from the host.

A list of common error responses is given in Section 6.9.1.

6.7.1 Command Descriptions

Table 6-5 List of RS-485 User Commands

Command	Description	Page	RST to Change
AO	Set analog output mode	83	
AOO	Get/Set analog output offset	83	
CA	Get calibration status	83	
DT	Perform diagnostic tests	84	
FAC	Set calibration to factory defaults	84	
GS	Modify gas species settings	85	
KP	Enable/Disable keypad	86	
LPF	Enable/Disable LPF (Low-Pass Filter)	86	
PC	Get or set process control setpoint value	86	
PCE	Enable/Disable relays	87	
PCH	Get or set process control setpoint hysteresis	87	
PCP	Get or set process control setpoint polarity	87	
PD	Modify programmable delay settings	87	
RD	Read the pressure	88	
RST	Reset the Controller	88	
RU	Read units of pressure	89	
SA	Set Address	89	Yes
SB	Set the baud rate	89	Yes
SC	Set communication	89	Yes
SN	Get the serial number	90	
SPE	Set parity and data bits (Even)	90	Yes
SPN	Set parity and data bits (None)	90	Yes
SPO	Set parity and data bits (Odd)	90	Yes
ST	Get/Set Convectron Gauge sensor type	90	
SU	Set the units of pressure	91	
SXVR	Set transceiver mode	91	
TS	Set span	91	
TZ	Set zero	91	
UC	Restore/save user configuration.	92	
VC	Void NIST calibration	93	
VER	Read code version	93	

NOTES:

"#01" is appended to all "From host computer" examples.

"*01" is appended to all "From 475 Controller" examples.

All of the examples below assume an address of 0x01.

See Section 6.9.1 for a list of common error messages.

AO	Analog Output	<p>Definition: Get/Set the analog output mode.</p> <p>Modifiers: 1, 2, or 3</p> <p>Possible Responses: *01 PROGM OK↵ ?01 INVALID↵ Invalid mode for current gas type.</p> <p>Example: From host computer: #01 AO1↵ (or AO2, or AO3) From 475 Controller: *01 PROGM OK↵</p> <ul style="list-style-type: none"> • Command AO1 sets the analog output to log 0-7V. • Command AO2 sets the analog output to log 1-8V. • Command AO3 sets the analog output to log 0-9V S-curve. <p>NOTE: The AO3 command applies ONLY when N2 is selected.</p>
AOO	Analog Output Offset	<p>Definition: Get/Set analog output offset voltage.</p> <p>Modifiers: 0 to 0.5</p> <p>Response: *01 PROGM OK↵</p> <p>Example: From host computer: #01 AOO 0.2↵ From 475 Controller: *01 PROGM OK↵ Sets analog output offset voltage by 0.2V.</p>
CA	Read NIST Traceability Calibration Status	<p>For NIST Traceable System Calibration:</p> <p>Definition: Calibration status</p> <p>Modifiers: None</p> <p>Possible Responses: ?01 CAL VOID↵ NIST traceable calibration is void. Equivalent to both VAC and ATM LED's being OFF. ?01 CAL CERT↵ NIST traceable calibration is valid. Equivalent to both VAC and ATM LED's being illuminated.</p>

DT Diagnostics Test

Definition: Perform diagnostics tests on A/D and analog out.

Modifiers: C, CS, CE, CP, CV, CD, A, A#, AD

Responses: See the examples, below.

Examples:

Command Root	From Host Computer	From 475 Controller	
DT	#01 DT↵	*01 PASS↵ Run auto test on A/D and analog output.	
		*01 FAIL↵ Both functions failed.	
		*01 AD FAIL↵ A/D failed.	
		*01 AO FAIL↵ Analog output failed.	
DTC	#01 DTC↵	*01 PASS↵ Run auto test on A/D.	
		*01 FAIL↵ A/D failed.	
	#01 DTCS↵	*01 1↵ Simulator enabled.	
		*01 0↵ Simulator disabled.	
	#01 DTCD↵	*01 PROGM OK↵ Disable simulator.	
	#01 DTCE↵	*01 PROGM OK↵ Enable simulator.	
	#01 DTCP1.00E-3↵	*01 PROGM OK↵ Set simulator pressure.	
	#01 DTCV5.534↵	*01 PROGM OK↵ Set simulator bridge voltage.	
	DTA	#01 DTA↵	*01 PASS↵ Run auto test on analog output.
			*01 FAIL↵ Analog output test failed.
#01 DTA5.00↵		*01 PROGM OK↵ Set analog output voltage.	
#01 DTAD↵		*01 PROGM OK↵ Resume pressure reporting to analog output.	

FAC Set Calibration to Factory Defaults

Definition: Set factory default

Modifiers: None

Possible Responses: *01 PROGM OK↵
?01 INVALID↵ Invalid if the Controller is NIST calibrated. See Section 3.11.5.

Example: From host computer: #01 FAC↵
From 475 Controller: *01 PROGM OK↵

NOTES:

FAC will cause default VAC and ATM parameters to be programmed to the factory default settings.

GS Gas Species

Definition: Get/Set gas species commands. See *Gas Species* on page 35 for a detailed explanation.

Modifiers: N₂ (Nitrogen), AR (Argon), HE (Helium), CO₂ (Carbon Dioxide), O₂ (Oxygen) FS (Factory Specified), CF (Correction Factor).

Responses: See the examples, below.

Examples:

Command Root	From Host Computer	From 475 Controller
GS	#01 GS↵	*01 N ₂ ↵ (or AR↵, HE↵, CO ₂ ↵, O ₂ ↵, FS↵, or CF↵) (FS = Factory Specified curve / CF = Correction Factor)
	#01 GSN2↵(or AR, HE, CO2, O2, FS, CF)	*01 PROGM OK↵ Set the gas species to the gas being used.
		?01 INVALID↵ The system is NIST calibrated.
	#01 GSFS↵	?01 INVALID↵ The data in memory is not valid or the system is NIST calibrated.
	#01 GSCF↵	*01 1.5↵ The correction factor being used. (CF of 1.5 in this example)
	#01 GSCF 1.0↵	*01 PROGM OK↵ Set the gas species to a new correction factor (0.1 to 1.5 in 0.1 increments) (this example: 1.0 CF).
	#01 GSCF 1.0, 200↵	*01 PROGM OK↵ Set the gas species to a new correction factor, and maximum pressure (0.1 to 5 CF and 1mTorr to 999 Torr) (this example: 1.0 CF and 200 Torr).
	#01 GSCFP↵	*01 1.00E+2↵ Get current max pressure setting (this example: 100 Torr).
	#01 GSCFP 150↵	*01 PROGM OK↵ Set the gas species to the correction factor, and maximum pressure (1mTorr to 999 Torr) (this example: 150 Torr).

KP	Keypad	Definition:	Get the keypad status, or Enable/Disable the keypad on the 475 Controller.
		Modifiers:	1 or 0 (1 = enable, 0 = disable).
		Possible Responses:	*01 PROGM OK↵
		Examples:	From host computer: #01 KP↵ Get the Keypad status (Enabled or Disabled) From 475 Controller: *01 1↵ or *01 0↵ From host computer: #01 KP1↵ Enable keypad or #01 KP0↵ Disable keypad From 475 Controller: *01 PROGM OK↵
LPF	Low-Pass Filter	Definition:	Enables another order of low-pass filtering for the pressure reading.
		Modifiers:	1 or 0 (1 = enable, 0 = disable).
		Response:	*01 PROGM OK↵
		Example:	From host computer: #01 LPF1↵ Enable Low-Pass Filter, or #01 LPF0↵ Disable Low-Pass Filter From 475 Controller: *01 PROGM OK↵
PC	Set Setpoint Pressure	Definition:	Setpoint pressure setting.
		Modifiers:	1 or 2; x.xxEx±xx (pressure range is .1 mTorr to 999 Torr)
		Possible Responses:	*01 X.XXE±XX↵ ?01 INVALID↵ Invalid if the option is not installed.
		Example:	From host computer: #01 PC 1 From 475 Controller: *01 4.35E-02↵

PCE Relays

Definition: Enable/Disable relays.
 Modifiers: 1 or 0 (1 = enable, 0 = disable).
 Possible Responses: *01 PROGM OK↵
 Examples:

Command Root	From Host Computer	From 475 Controller
PCE	#01 PCE↵ Get relay status.	*01 PROGM OK↵
	#01 PCE01↵ Enable Relay 1, disable relay 2	*01 PROGM OK↵
	#01 PCE10↵ Enable Relay 2, disable relay 1	*01 PROGM OK↵
	#01 PCE11↵ Enable both relays.	*01 PROGM OK↵
	#01 PCE00↵ Disable both relays.	*01 PROGM OK↵

If a relay is disabled, it must be re-enabled it to make it operable. The previous relay settings are still applicable and can be recalled.

Enabling or disabling a relay that doesn't exist results in a syntax error.

PCH Process Control Setpoint Hysteresis

Definition: Set the process control setpoint hysteresis.
 Modifiers: 1, or 2 (for setpoint 1 or 2).
 Possible Responses: *01 PROGM OK↵
 ?01 RANGE ER↵ The value entered is <5 or >1000.
 Examples:
 From host computer: #01 PCH1↵ Get setpoint 1 hysteresis.
 From 475 Controller: *01 200↵ Setpoint 1 hysteresis is 200%
 From host computer: #01 PCH2 100↵ Set setpoint 2 hysteresis.
 From 475 Controller: *01 PROGM OK↵ The setpoint hysteresis is 100%.

PCP Set Process Control Setpoint Polarity

Definition: Set the polarity of the relay activation.
 Modifiers: 1 or 2; + or -
 Possible Responses: *01 PROGM OK↵
 ?01 INVALID↵ Invalid if the option is not installed.
 Example:
 From host computer: #01 PCP1 +↵
 From 475 Controller: *01 PROGM OK↵

PD Set Delay

Definition: Pressure filtering response delay.
 Modifiers: 0 to 200 ms (Modified values are rounded to the nearest 10 ms.)
 Possible Responses: *01 PROGM OK↵
 ?01 RANGE ER↵ Modifier value is out of range

Examples:

Command Root	From Host Computer	From 475 Controller
PD	#01 PD↓ Get (show) the current delay setting.	*01 150↓
	#01 PD10↓ Set 10 ms delay.	*01 PROGM OK↓
	#01 PD150↓ Set 150 ms delay.	*01 PROGM OK↓

Response Delay provides a delayed readout of the indicated pressure. The delay time can be set in 10 millisecond increments for the 475 Controller to display a pressure reading. Also, see LPF.

RD Read Pressure

Definition: Read Convectron Gauge pressure response

Modifiers: None

Possible Responses:

- *01 9.34E-02↓ Pressure value
- ?01 OPN SNSR↓ Defective transducer
- ?01 SNSR UNP↓ Sensor is unplugged
- ?01 SNSR UDP↓ Under pressure, limit related to TZ command
- ?01 SNSR OVP↓ Pressure higher than 999 Torr, or gases other than the selected gas type in the system are causing the indicated pressure to be above 999 Torr. (Atmosphere pressure of helium will cause this response.)

Example:

From host computer: #01 RD↓ (for address of 01)

From 475 Controller: *01 9.34E-02↓

ASCII string representing pressure in scientific notation. Three significant digits except in 10^{-3} Torr range with 2 significant digits and a zero filler, 10^{-4} Torr range with 1 significant digit with 2 zero fillers.

While at vacuum, the output should be 0.00E-04 (= 0.0 mTorr displayed.) An output of SNSR UDP (= -0.0 mTorr displayed) occurs when the transducer voltage at vacuum has drifted lower than that set by the TZ command. The response to RD received at vacuum may fluctuate under normal operation, but if the SNSR UDP error appears consistently, calibration may be required. See Section 3.11 and TZ Set Zero Command.

RST Reset Controller

Definition: Reset the 475 Controller

Modifiers: None

Response: None

Example: From host computer: #01 RST↓

NOTES:

The RST command will reset the Controller as if the power had been cycled. The RST command has no response but resets the Controller operation. Communication is re-enabled in approximately 2 seconds.

RU	Read Pressure Unit	<p>Definition: Identifies the currently selected units of pressure.</p> <p>Modifiers: Torr, mbar, Pascal.</p> <p>Possible Responses: *01 TORR or *01 MBAR or *01 PASCAL</p> <p>Example: From host computer: #01 RU↵ From 475 Controller: *01 TORR</p> <p>See SU (Set Unit of Pressure) to change the displayed unit of measurement to another.</p>
SA	Set Address	<p>Definition: Set the address</p> <p>Modifiers: Address in hex</p> <p>Response: *01 PROGM OK</p> <p>Example: From host computer: #01 SA20↵ (Sets address to 0x20.) From 475 Controller: *01 PROGM OK↵</p> <p>NOTES: The operating address will not change until the power is cycled or RST is sent. The value displayed and used is a 2 digit ASCII representation of the hex value. The value must be in the range of 0x00 to 0x40 inclusive.</p>
SB	Set Baud Rate	<p>Definition: Set the baud rate</p> <p>Modifiers: 1200, 2400, 4800, 9600, 14400, 19200, 28800, 38400</p> <p>Response: *01 PROGM OK↵</p> <p>Example: From host computer: #01 SB2400↵ From 475 Controller: *01 PROGM OK↵</p> <p>NOTES: The baud rate needs to be set at a valid rate, i.e., 1200, 2400, 4800, 9600, 14400, 19200, 28800, 38400. If the rate is set to an odd value, for example 2234, the Controller will stay at the present rate and respond with ?01 SYNTAX ERR. Cycle power or send RST after sending this command to enable changes.</p>
SC	Set Communication	<p>Definition: Set the communication wiring protocol</p> <p>Modifiers: 485 or 422</p> <p>Response: *01 PROGM OK↵</p> <p>Example: From host computer: #01 SC485↵ From 475 Controller: *01 PROGM OK↵</p> <p>NOTES: Send SC485 for 2-wire RS485 operation, SC422 for 4-wire RS-485/422 operation. Default configuration is RS485/422 4-wire communication. The Controller will continue to operate at the old configuration until power is cycled or RST command is sent. Cycle power or send RST after sending this command to enable changes.</p>

SN	Serial Number	Definition: Get the serial number of the 475 Controller. Modifiers: None. Response: *01 475A1234↓ Example: From host computer: #01 SN↓ From 475 Controller: *01 475A1234↓ The serial number can be up to 16 characters long.
SPE	Set Parity to 7 Bits/Even Parity Check	Definition: Set bits/parity to 7 bits/even, 1 stop bit Modifiers: None Response: *01 PROGM OK↓ Example: From host computer: #01 SPE↓ From 475 Controller: *01 PROGM OK↓ Cycle power or send RST after sending this command to enable changes.
SPN	Set Parity to 8 Bits/Even Parity Check	Definition: Set bits/parity to 8 bits/none, 1 stop bit Modifiers: None Response: *01 PROGM OK↓ Example: From host computer: #01 SPN↓ From 475 Controller: *01 PROGM OK↓ Cycle power or send RST after sending this command to enable changes.
SPO	Set Parity to 7 Bits/Odd Parity Check	Definition: Set bits/parity to 7 bits/odd, 1 stop bit Modifiers: None Response: *01 PROGM OK↓ Example: From host computer: #01 SPO↓ From 475 Controller: *01 PROGM OK↓ Cycle power or send RST after sending this command to enable changes.
ST	Get/Set Convectron Gauge Sensor Type	Definition: Get/Set the gauge sensor type (Gold-plated tungsten or Platinum) Modifiers: Au, Pt Possible Responses: *01 AU↓ or *01 PT↓ or *01 PROGM OK↓ Examples: From host computer: #01 ST↓ get currently selected sensor type From 475 Controller: *01 AU↓ current sensor type is gold-plated tungsten From host computer: #01 ST PT↓ change sensor type to Platinum From 475 Controller: *01 PROGM OK↓

SU	Set Unit of Pressure	Definition: Modifiers: Possible Responses: Example:	Selects and sets the units of pressure measurement. T, M, or P (Torr, mbar, or pascal). *01 PROGM OK↵ From host computer: #01 SUT↵ From 475 Controller: *01 PROGM OK↵
SXVR	Set Transceiver Mode	Definition: Modifiers: Response: Example:	Sets the transceiver switching time from receiver mode to transmit mode. This effectively adjusts the delay of the beginning of the response message. The default is FAST. F or S (Fast or Slow) *01 PROGM OK↵ #01 SXVRF↵
TS	Set Span	Definition: Modifiers: Possible Responses: Example:	Set span (typically at atmospheric pressure) Pressure Value (above 399 Torr) *01 PROGM OK↵ Other possible responses: ?01 GAIN LIM↵ Gain programmed at limit. Readout will be the pressure at max TS setting. ?01 OPN SNSR↵ Sensor defect, no change in calibration. See Section 8.5. ?01 SNSR UNP↵ Sensor unplugged, no change in calibration. ?01 RANGE ERR↵ Command error. TS must be set above 399 Torr, and system pressure must be above 399 Torr. ?01 INVALID↵ System is calibrated and locked. From host computer: #01 TS 7.60E+02↵ From 475 Controller: *01 PROGM OK↵
			Do this only at pressures above 399 Torr; The Controller will respond with RANGE ERR if done below 399 Torr or near vacuum. The change occurs as soon as the function is performed. If the Controller is NIST calibrated, the response for this command will be INVALID. See Section 3.11.5.
TZ	Set Zero	Definition: Modifiers: Possible Responses:	Set zero 0 or pressure below 1×10^{-1} Torr in scientific notation *01 PROGM OK↵ ?01 OFST LIM↵ Offset programmed at limit. Readout will be the pressure at max TZ setting. ?01 OPN SNSR↵ Sensor defect. No change in calibration. See Section 8.5.

?01 SNSR UNP↵ Sensor unplugged. No change in calibration.

?01 RANGE ER↵ Command error. TZ must be set below 1×10^{-1} Torr, and system pressure must be below 1×10^{-1} Torr.

?01 INVALID↵ System is NIST calibrated and locked. See Section 3.11.5.

Examples:

From host computer: #01 TZ0↵

From 475: *01 PROGM OK↵

From host computer: #01 TZ1.00E-02↵

From 475 Controller: *01 PROGM OK↵

NOTES:

Do this only at pressures below 1×10^{-1} Torr. The response will be an error message if done near atmosphere. The change occurs as soon as the function is performed.

UC User Configurations

Definition: Save a program configuration or restore a previously saved configuration.

Modifiers: S (Save), R (Restore) or F (Factory) / 1, 2, or 3.

Possible Responses: *01 PROGM OK↵

Examples:

From host computer: #01 UCS1↵

From 475 Controller: *01 PROGM OK↵ Save the settings to the specified slot (#1 in this example).

From host computer: #01 UCR3↵

From 475 Controller: *01 PROGM OK↵ Restore the settings from the specified slot (#3 in this example).

“Save Configuration” allows the user to save up to three configurations in addition to the factory default configuration. Three different user settings can be programmed and saved. Each user setting will include the unique setpoint parameters, unit of measurement, analog output setting, computer interface parameters, atmosphere and vacuum calibrations, gas species setting, and display options.

“Restore Configuration” allows the user to switch to any of the four saved configurations. Four different configurations (one factory default and three user-set configurations) can be programmed and saved. Each user setting will include unique setpoint parameters, unit of measure, analog output setting, computer interface parameters, atmosphere and vacuum calibrations, gas species setting, and display options. Initial user settings are programmed to the factory defaults.

VC	Void NIST Calibration	For NIST Traceable System Calibration: Definition: Void NIST calibration Modifiers: None Response: *01 PROGM OK.␣ Calibration functions are now unlocked. TS, TZ, and FAC commands will now work.
VER	Read Version	Definition: Read code version Modifiers: None Response: Code version number Example: From host computer: #01 VER.␣ From 475 Controller: *01 030409-C.␣
6.8	Command-Response Timing	The timing diagram illustrated in Figure 6-2 depicts the time it takes for a command to be transmitted to the 475 Controller, processed, a response sent back, and for the communication bus to be ready for another transmission.

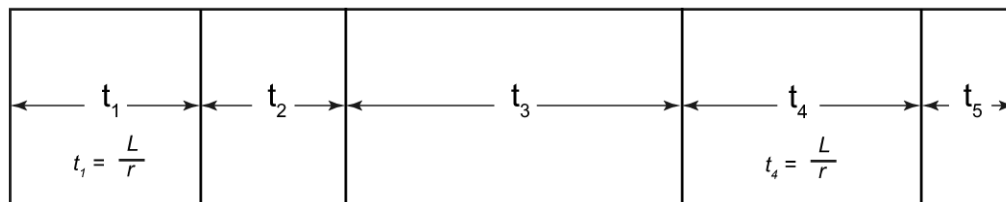
Figure 6-2 Command Response Timing Diagram

t_1 - Duration of the transmission of the command from the host to the 475 Controller. This is dependent on the Length (L) of the command in bits and the baud rate (r).

$$t_1 = L/r$$

t_2 - Duration for the 475 Controller to process the command. This is dependent on the command but is typically less than 20 milliseconds. Commands to save/restore user profiles (UC) can take up to 75 milliseconds. Diagnostic commands (DT) can take up to 500 milliseconds.

t_3 - Amount of time for the 475 Controller to wait before transmitting the response. This is dependent on the Transceiver Mode setting and is approximately 2 milliseconds for the "fast" setting and 15 milliseconds for the "slow" setting.

t_4 - Duration of the transmission of the response from the 475 Controller to the host. This is dependent on the Length (L) of the command in bits and the baud rate (r).

$$t_4 = L/r$$

t_5 - Amount of time for the transceiver in the 475 Controller to switch the driver into high-impedance, thereby releasing the bus. This is less than 4 microseconds.

6.9 RS-485 Troubleshooting

Because the RS-485 standard is found in various configurations, check the following configuration options:

1. Check the RS-485 settings via the front panel of the 475 Controller. If there is no response, check the address of the Controller. Be sure the baud rate, bus type, transceiver mode, and parity match the requirements of the host computer or terminal. There may be several mismatched parameters.
2. Check the interface wiring. The pin assignments for the RS-485/422 modes are shown in Section 6.4.1 on page 80. The "Received" or "Transmitted" data lines are defined as seen by the Controller.
3. Check the command syntax. Be sure the string sent to the Controller is entered correctly. See Section 6.6 on page 81.

6.9.1 RS-485 Error Messages

If an error is found in the incoming message, the following messages will be returned in place of the normal response.

No Response or garbled output

- Baud rate incorrect
- Character length, parity, or stop bit(s) incorrect
- Bad cable or connection
- Command does not include $0D_{\text{hex}}$ (\downarrow) terminator character

OVERRUN ERROR

Returned if the incoming message overflows the Controller's buffer. This may indicate a flaw in the host software.

PARITY ERROR

Returned if the parity of a byte in the incoming message does not match the setting in the 475 Controller.

SYNTAX ERROR

Returned if the message fails to parse as a valid Controller command.

F P ERROR

Returned if a function is being controlled via the front panel inputs on the 475 Controller.

INVALID

Function is not valid or possible at this time.

Chapter 7 Diagnostics

The 475 has diagnostic functions to help determine if critical areas are operating correctly. Some diagnostic functions are continuously running and some require user interaction.

The Analog/Digital Converter (A/D) and the Analog Output are monitored continuously for errors.

Figure 7-1 Diagnostics Flow Chart

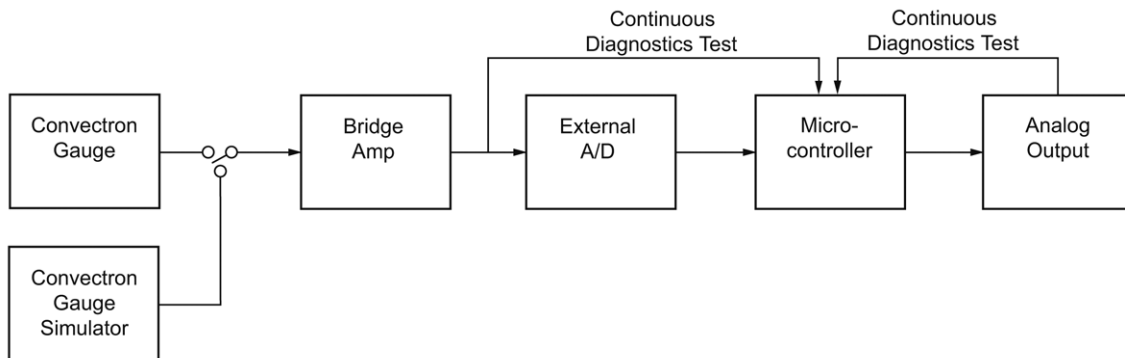
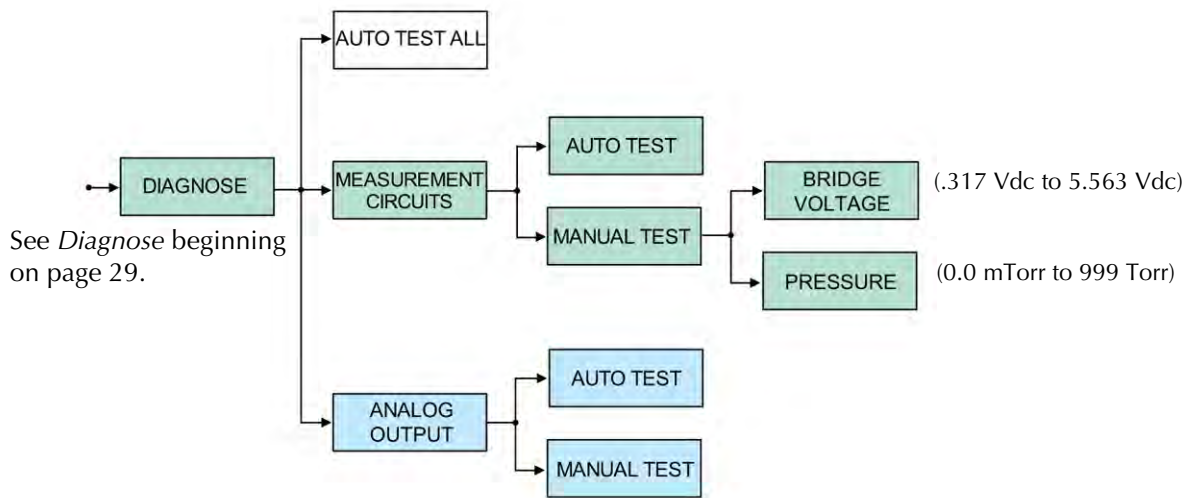

Figure 7-2 Diagnostics Menu



- 7.1 Continuous Diagnostics** The External A/D and the Analog Output are both monitored by the A/D onboard microcontroller automatically. Discrepancies are reported to the user through the errors "ADBAD" and "AOBAD".
- 7.2 Diagnostics Requiring User Interaction** User-interactive diagnostics can be accessed through the front panel, the RS-232 interface, or the RS-485 interface.

7.2.1 Analog Output

Auto

Runs the Analog Output through a voltage range and verifies the voltages are being met.

Example:

The pressure reported by the Analog Output is significantly different than the pressure reported by the display. With the Analog Output cable attached, the auto test reports a "FAIL". With the Analog Output cable disconnected, the auto test reports a "PASS". The problem is most likely external to the 475 Controller.

Manual

Allows the user to set the voltage to a specific voltage.

Example:

The Analog Output cable to a DMM is causing a small voltage drop because it is exceptionally long. Setting the manual test to 7V, the DMM reads 6.8V. A 0.2V offset can now be added to the Analog Output.

7.2.2 Measurement Circuits

Auto

Uses the Convector Simulator to check the External A/D and Bridge Amplifier through their ranges.

Example:

With the system at atmosphere, the Controller is showing a "CABLE" error. The auto test reports a "FAIL" - the problem is most likely with the Controller and not the cable or gauge.

Manual

Uses the Convector Simulator to set a bridge voltage or a pressure

Example:

When the Analog Output of the Controller gets below a certain voltage (corresponds to a pressure), an external process is started. The vacuum system is fairly large, requiring a long pump-down time.

The Convector Simulator is used to set (simulate) the pressure below the threshold to see if the Controller is working and to see if the external process is started. This can be done without waiting to pump-down the system.

7.3 Convectron Gauge Simulator

The 475 has an in-circuit Convectron Gauge Simulator that can be used for self-diagnostics or system setup. The simulator is controlled by a PWM-controlled voltage source similar to the Analog Output. It is calibrated in the same manner as the Analog Output. Changing the voltage of the simulator forces the Bridge Amplifier to change the voltage across a resistor network - effectively simulating a Series 275 gauge. The Convectron simulator can be operated from the front panel on the 475 Controller, or through the RS-232 interface. "Test Mode" is displayed across the bottom of the front panel display screen when the Convectron Simulator is enabled. Access to the Simulator via the Controller front panel is by entering the Diagnose functions. See the 475 Controller Menu Flowchart on page 28 in the Operation Chapter and the Diagnostics Menu on page 95.

Two relays and an analog switch are used to switch the simulator in and out of the Bridge Amplifier network.

NOTE: The Convectron Gauge Theory of Operation is explained in Section 3.8 on page 40.

Figure 7-3 Convectron Simulator Theory of Operation Schematic

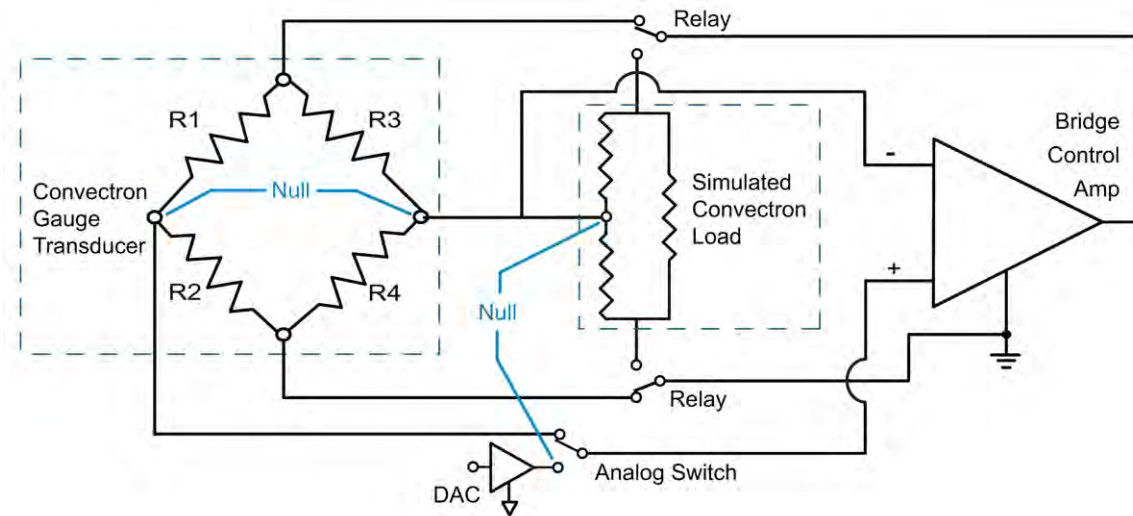

The 3 primary functions of the Convectron Gauge Simulator are:

1. Send an Analog Output signal and Setpoint signals to the system process Controller to simulate a system process operation.
2. Provide a self-diagnostics tool to check the 475 Controller to assure that it is operating properly.
3. Calibration of the analog inputs/outputs between the 475 Controller and the system process Controller.

7.3.1 Simulate a Process Operation Prior to Full System Integration

The Test and measurement circuit can be used to test and troubleshoot the 475 process control outputs prior to full vacuum chamber operation. The 475 Controller can be put in the manual mode and simulated pressures entered, causing the process control channels to change state.

During the initial setup of an Analog input channel for the System Process Controller for system process control, it may be helpful to calibrate the process voltage input to the pressure displayed on the 475 Controller. The

display and analog outputs can be set to a specific pressure, and the system process controller pressure input calibrated to match the pressure display of the 475 Controller.

The voltage displayed during the simulation mode is the bridge voltage of the Convector Gauge and not the analog output voltage from the 475 Controller. To set the 475 Controller output voltage to a specific value, see the section on Analog Output Test.

If, during normal operation of a process, a non-functioning valve or lockout has locked the system operation, the Convector Simulator can be used to override the non-functioning system component.

7.3.2 Analog Output Tests

The Analog output voltage of the 475 Controller can be set to a specific value for setting system calibration points. For instance, to calibrate the vacuum system process controller at 10 V, set the analog output voltage of the 475 Controller to 10V and calibrate the system process controller to display 10 V.

7.3.3 Controller Calibration Verification

The voltage measurement circuit of the 475 Controller can be verified on a yearly basis to assure the unit remains properly calibrated. The output of the Simulated Measurement Circuit can be measured using an external voltmeter on pins 1 and 9 of the Convector Gauge 9 pin D connector on the back of the Controller. (See Figure 2-15 on page 25.) Measurement of this simulated bridge voltage against the pressure displayed on the front panel is a check of the Controller's stability. This test verifies ONLY the factory calibration - Not a user applied calibration.

Vacuum calibration services are available through MKS for validating the accuracy of the Convector Gauge and measurement system. Contact Customer Service for additional details.

Chapter 8 Service and Maintenance

8.1 Customer Service

Some minor problems are readily corrected on site. If the product requires service, contact the MKS Technical Support Department at 1-303-652-4400 or 1-800-776-6543 for troubleshooting help over the phone.

If the product must be returned to the factory for service, request a Return Material Authorization (RMA) from MKS, which can be completed at <https://www.mksinst.com/service/servicehome.aspx>. Do not return products without first obtaining an RMA. In most cases a hazardous materials disclosure form is required. The MKS Customer Service Representative will advise you if the hazardous materials document is required.

When returning products to MKS, be sure to package the products to prevent shipping damage. Damaged returned products as a result of inadequate packaging is the Buyer's responsibility.

For Customer Service / Technical Support:

MKS Pressure and Vacuum Measurement Solutions

MKS Instruments, Inc.
6450 Dry Creek Parkway
Longmont, Colorado 80503 USA
Tel: 303-652-4400
Fax: 303-652-2844
Email: mks@mksinst.com

MKS Corporate Headquarters

MKS Instruments, Inc.
2 Tech Drive, Suite 201
Andover, MA 01810 USA
Tel: 978-645-5500
Fax: 978-557-5100
Email: mks@mksinst.com

8.2 Service Guidelines

Because the 475 Controller contains static-sensitive electronic parts, the following precautions must be followed when troubleshooting:

- Use a grounded, conductive work surface. Wear a high impedance ground strap for personal protection.
- Use conductive or static dissipative envelopes to store or ship static sensitive devices or printed circuit boards.
- Do not operate the Controller with static sensitive devices or other components removed from the Controller.
- Do not handle static sensitive devices more than absolutely necessary, and only when wearing a ground strap.
- Do not use an ohmmeter for troubleshooting MOS circuits. Rely on voltage measurements.
- Use a grounded, electrostatic discharge safe soldering iron.

This Controller is designed and tested to offer reasonably safe service provided it is installed, operated, and serviced in strict accordance with these safety instructions.

8.3 Damage Requiring Service

Turn OFF power to the Controller and refer servicing to qualified service personnel under the following conditions:

- If any liquid has been spilled onto, or objects have fallen into, the Controller.
- If a circuit board is faulty.
- If the Convectron Gauge sensing wire is open or the gauge is contaminated.
- If the Controller has been exposed to moisture.
- If the Controller does not operate normally even if you follow the operating instructions. Adjust only those controls that are explained in this instruction manual. Improper adjustment of other controls may result in damage and will often require extensive work by a qualified technician to restore the Controller to its normal operation.
- If the Controller has been dropped or the enclosure has been damaged.
- If the Controller exhibits a distinct change in performance.

8.4 Error Codes and Possible Solutions

Table 8-1 lists failure symptoms and error codes, possible causes, and possible solutions.

NOTE: Running the Controller diagnostics can possibly assist you in determining if the problem is with the 475 Controller or the Convector Gauge.

Table 8-1 Failure Symptoms or Error Codes, Possible Causes, and Possible Solutions

Symptom or Error Code	Possible Causes	Possible Solutions
The Controller will not power-up, no response to the power switch.	<ol style="list-style-type: none"> 1. Power interconnect cable improperly connected (see page 23). 2. Over voltage, under voltage, or over current to the Controller. 	<ol style="list-style-type: none"> 1. Check the power supply cable and power to the 475 Controller. 2. Check the power to the Controller, which must be 12 to 24 Vdc, 6 W continuous.
The displayed pressure reading is higher than expected.	<ol style="list-style-type: none"> 1. Poor gas conductance at the gauge-to-chamber vacuum connection or a gas source in the plumbing to the gauge, such as a leak or contamination. 2. The Convector Gauge is mounted too far from the area of desired measurement. For example, the gauge could be mounted on a long adapter tube or chamber fitting that prevents the gauge from reading the actual pressure in the chamber. 3. The Controller is out of calibration. 4. Unknown gas type in the vacuum chamber 5. The Convector Gauge is not mounted horizontally. 6. Extremes of temperatures or vibration of the Convector Gauge. 7. The sensor wire in the Convector Gauge is damaged or contaminated. 	<ol style="list-style-type: none"> 1. Check the system for leaks and repair as required. 2. Make sure the gauge is mounted close to the location where pressure measurement is desired. 3. Recalibrate the Controller. See <i>Calibration</i> on page 51. 4. Check the gas type being used and make sure the proper correction curves or settings are being used for that specific gas. 5. Remount the gauge if necessary. See <i>Install the Convector Gauge</i> on page 20. 6. Remount the gauge if necessary. See <i>Install the Convector Gauge</i> on page 20. 7. Check and clean or replace the gauge. See <i>Convector Gauge Test Procedure</i> on page 103 and <i>Cleaning Contaminated Convector Gauges</i> on page 103.
ERR 01 CGBAD	<ol style="list-style-type: none"> 1. The Convector Gauge is either unplugged or defective. The reported pressure is 999T, and the relays are OFF. 2. The Controller is out of Calibration. 	<ol style="list-style-type: none"> 1. Check the cable between the gauge and the Controller, and replace it if necessary. Check and clean or replace the gauge. See <i>Convector Gauge Test Procedure</i> on page 103 and <i>Cleaning Contaminated Convector Gauges</i> on page 103. 2. Check the calibration and reset if necessary, See <i>Calibration</i> on page 51.
ERR 09 NVRAM	<ol style="list-style-type: none"> 1. Not able to retrieve information from EEPROM. 	<ol style="list-style-type: none"> 1. Turn OFF, and turn ON power to the Controller.
ERR 14 CABLE	<ol style="list-style-type: none"> 1. The cable is either unplugged or defective. The reported pressure is 999T, and the relays are OFF. 	<ol style="list-style-type: none"> 1. Check the cable between the gauge and the Controller, and replace it if necessary.

Table 8-1 Failure Symptoms or Error Codes, Possible Causes, and Possible Solutions

Symptom or Error Code	Possible Causes	Possible Solutions
ERR 15 ADBAD	<ol style="list-style-type: none"> 1. The Analog/Digital Converter (A/D) is reporting an erroneous value. 2. The reported pressure is 999T, and the relays are OFF. 	<ol style="list-style-type: none"> 1. Turn OFF, and turn ON power to the Controller. 2. Check the calibration and reset if necessary, See <i>Calibration</i> on page 51.
ERR 16 AOBAD	<ol style="list-style-type: none"> 1. The Analog Output is reporting an erroneous value. 2. The microcontroller A/D is damaged. 	<ol style="list-style-type: none"> 1. Turn OFF, and turn ON power to the Controller. 2. Can still be used if the pressure reporting is still accurate.
ERR 17 OVPRS	<ol style="list-style-type: none"> 1. The maximum pressure limit has been reached. The reported pressure is the maximum reported pressure for the gas species (999 Torr for N₂). 2. The gauge is contaminated or damaged. 3. The Controller is out of calibration. 	<ol style="list-style-type: none"> 1. Check to be sure that the actual pressure is within the range of the Controller. If it is, recalibrate the Controller or replace the gauge. 2. Check and clean or replace the gauge. See <i>Convectron Gauge Test Procedure</i> on page 103 and <i>Cleaning Contaminated Convectron Gauges</i> on page 103. 3. Check the calibration and reset if necessary, See <i>Calibration</i> on page 51.
ERR 18 FAC	<ol style="list-style-type: none"> 1. CRC-16 checksum verification of factory settings has failed. 	<ol style="list-style-type: none"> 1. The Controller will automatically revert to the default values.
ERR 19 FS	<ol style="list-style-type: none"> 1. CRC-16 checksum verification of "FS" curve has failed. 	<ol style="list-style-type: none"> 1. Revert to the N₂ or other gas curve.

8.5 Convectron Gauge Test Procedure

The small diameter sensor wire can be damaged by even small voltages. Do not perform electrical continuity tests with instruments applying in excess of 0.1 V when the gauge is at vacuum, or 2 V when at atmospheric pressure.

The Convectron gauge should show the resistances listed in Figure 8-1 (pin numbers are embossed on the gauge cable connector).

Figure 8-1 Convectron Gauge Pins



- Pins 1 to 2: 18 to 23 ohms
- Pins 2 to 3: 50 to 60 ohms
- Pins 1 to 5: 180 to 185 ohms

If the resistance from pins 1 to 2 reads about 800 ohms, the sensor wire in the gauge is broken. Replace the Convectron Gauge.

Note: If the resistance values shown here are correct, but you still think the gauge is not reading correctly, the gold plating on the tungsten sensor wire may be eroded and the gauge will have to be replaced.

8.6 Cleaning Contaminated Convectron Gauges

When the small sensor wire in the Convectron Gauge is contaminated with oil or other films, its emissivity or its diameter may be appreciably altered and a change of calibration will result.

Baking to clean the gauge:

The Convectron Gauge may be baked to 150 °C nonoperating while under vacuum with the cable disconnected. All materials used in the Convectron Gauge are corrosion resistant, and bakeable to 150 °C.

Chemically cleaning the gauge:

Cleaning with trichloroethylene, perchloroethylene, toluene, or acetone is possible but it must be done very carefully to not damage the sensor wire.

! WARNING

Use of flammable solvents near an open flame or energized electrical equipment can cause an explosion or fire.

To avoid product damage or personal injury due to explosion or fire, use flammable solvents such as acetone and toluene only in a well-ventilated area that exhausts to the outdoors. Do not use such solvents near an open flame or energized electrical equipment.

Exposure to fumes from solvents in an improperly ventilated area can cause personal injury.

To avoid personal injury from inhaling fumes from solvents such as trichloroethylene, perchloroethylene, toluene, and acetone, use these solvents only in a well-ventilated area that exhausts to the outdoors.

Hold the gauge with the main body horizontal and the port projecting upward at an angle of 45 degrees. Slowly fill it with solvent using a standard wash bottle with the spout inserted in the port to the point where it touches the screen. Let the solvent stand in the gauge for at least ten minutes. **Do not shake the gauge.** Shaking the gauge with liquid inside can damage the sensor wire. To drain the gauge, position it horizontally with the port facing downward. Slightly warming the gauge will help dry the gauge. Allow the gauge to dry overnight with the port vertically downward and uncapped. Before re-installing the gauge on the system, be certain no solvent odor remains.

8.7 **Reset to Factory Defaults**

Follow the procedure below to return the Controller to its factory default settings:

To reset VAC and ATM back to their original factory settings, turn OFF the Controller and hold the ENTER button while turning ON power to the Controller. "Restore Factory Calibration" is displayed for approximately three seconds. The Controller will then resume normal power-on operation.

- A**
 Analog Output
 From Convectron Gauge **53**
 Scaling **56**
- B**
 Before You Begin
 Caution and Warning Statements **9**
 Damage Requiring Service **12**
 Reading and Following Instructions **9**
 Button Overview **27**
- C**
 Calibrate
 How To **30**
 Calibration
 Atmosphere **51**
 NIST Traceable **52**
 Preparing for Operation **51**
 Vacuum **51**
 Caution and Warning Statements **9**
 Chapters
 Installation **15**
 Preparing for Operation **27**
 Process Control **57**
 RS-232 Interface **61, 77**
 Service and Maintenance **95, 99**
 Command Syntax
 RS-232 **65**
 Connectors
 Controller **25**
 Controller
 Catalog Numbers **4**
 Connectors **25**
 Error Codes **39**
 Factory Defaults **16**
 Ordering Information **4**
 Convectron Gauge
 Analog Output Signal **53**
 Catalog Numbers **4**
 Cleaning **103**
 Grounding **22**
 Installation **20**
 Ordering Information **4**
 Preparing for Operation **40**
 Simulator **97**
 Test Procedure **103**
 Theory of Operation **40**
 Customer Service **99**
- D**
 Damage Requiring Service **12, 100**
 Default Settings **104**
 Diagnostics **95**
 How to **29**
 Display
 Setpoints **58**
- E**
 Error Codes
 Controller **39**
 Troubleshooting **101**
 Explosion/Implosion Danger **10**
 Explosive Gases **10**
- F**
 Factory Defaults
 Controller **16**
 RS-232 **16**
 RS-485 **17**
 Flowchart
 Menu **28**
- G**
 Gases
 Explosive **10**
 Other than N2 or Air **41**
 Selecting **35**
 Grounding
 Convectron Gauge **22**
 System **10**
- I**
 Implosion/Explosion Danger **10**
 Initial Power Up **27**
 Installation
 Configure the Relays **26**
 Connect the Wiring **23**
 Convectron Gauge **20**
 Mount the Controller **18**
 Pre-Installation Considerations **17**
 Pressure Relief Devices **18**
 Requirements for Process Control Option **26**
 System Components **15**
 Vacuum Chamber Fittings **21**
- M**
 Menu
 Flowchart **28**
 Overview **28**

O

- Overpressure Conditions **10**
- Overview
 - buttons **27**

P

- Power Up
 - Initial **27**
- Preparing for Operation
 - Analog Output Scale **56**
 - Button Overview **27**
 - Calibration **51**
 - Convectron Gauge **40**
 - Convectron Gauge Analog Output **53**
 - Pressure Measurement **27**
- Preparing RS-232 **64**
- Pressure Relief Devices **18**
- Process Control
 - Connecting Relays **58**
 - Requirements **26**
 - Setpoint Display and Adjustment **58**
 - Settings **59**
 - Setup **57**

R

- Reading and Following Instructions **9**
- Relays
 - Configuring for Application **26**
 - Connecting **58**
 - Setpoint Display and Adjustment **58**
- RS-232
 - Command Syntax **65**
 - Error Messages **75**
 - Handshake **62**
 - Preparing **64**
 - Reset to Factory Defaults **67**
 - Theory of Operation **61, 77**
 - Troubleshooting **75, 103**
 - User Commands, List of **65**
 - Wiring **61**
- RS-485
 - Address Settings **78**
 - Baud Rate Settings **77**
 - Byte Format **77**
 - Command Descriptions **82**
 - Command Response Timing **93**
 - Command Syntax **81**
 - Command-Response Timing **64, 93**
 - Communications Protocol **81**
 - Computer Interface **80**
 - Connecting the Interface **80**
 - Connector Pin Assignments **80**
 - Default Settings **77**
 - Error Messages **94**
 - Factory Default Settings **77**

- Interface Settings **77**
- Physical Configurations **78**
- Response Syntax **81**
- Troubleshooting **94**

S

- Service
 - Guidelines **11**
- Service and Maintenance
 - Convectron Gauge Test Procedure **103**
 - Customer Service **99**
 - Damage Requiring Service **100**
 - Factory Default Settings **104**
 - Service Guidelines **99**
- Service Guidelines **99**
- Setpoints
 - Indicators **35**
 - Process Control **31**
- Settings
 - Factory Default **104**
- Settings for Process Control **59**
- Simulator
 - Convectron Gauge **97**
- Specifications
 - Controller & Gauge **13**
 - Controller Dimensions **14**
- System Components
 - Installation **15**
- System Grounding **10**
- System Menu
 - Flowchart **28**

T

- Theory of Operation
 - Convectron Gauge **40**
 - Convectron Gauge Simulator **97**
 - RS-232 **61, 77**
- Tranceiver Mode **78**
- Troubleshooting
 - Error Codes **101**
 - RS-232 **75, 103**

U

- User Commands
 - RS-232 **65**

W

- Warranty **11**
- Wiring
 - RS-232 **61**
 - RS-485 **80**

Series 475

Series 475 Convectron® Vacuum Measurement Controller



Customer Service / Technical Support:

MKS Pressure and Vacuum Measurement Solutions

MKS Instruments, Inc.
6450 Dry Creek Parkway
Longmont, Colorado 80503 USA
Tel: 303-652-4400
Fax: 303-652-2844
Email: mks@mksinst.com

MKS Corporate Headquarters

MKS Instruments, Inc.
2 Tech Drive, Suite 201
Andover, MA 01810 USA
Tel: 978-645-5500
Fax: 978-557-5100
Email: mks@mksinst.com

Instruction Manual

Instruction manual part number 475101

Revision I - September 2017