

# MKS Series 946 Vacuum System Controller



## Operation and Maintenance Manual

# Table of Contents

Package Contents .....	5
1 Safety Information .....	6
1.1 Symbols Used in this Manual and their definitions .....	6
1.2 Safety Precautions .....	6
1.2.1 Safety Procedures and Precautions .....	6
2 Specifications .....	8
2.1 Controller .....	8
2.2 Sensors .....	10
2.3 Controller Display .....	14
2.3.1 Display Message .....	14
2.3.2 Display Resolutions.....	15
2.3.3 Serial Communication Response Format .....	16
3 Feature, Control Locations and Dimensions .....	17
4 Typical Applications for the Series 946 Controller .....	19
5 HPS® Products Series 946 Vacuum System Controller .....	20
6 Operating the Series 946 Controller .....	22
6.1 Power .....	22
6.2 Front Panel Control Lock.....	22
6.3 Front Panel Display .....	22
6.3.1 Standard Front Panel Display .....	22
6.3.2 Large Font Displays .....	24
6.3.3 LCD Screen Saver .....	24
6.4 System Setup .....	24
6.4.1 Overview of 946 System Setup .....	24
6.4.2 Display System Setup Parameters .....	25
6.4.3 Change and Save a Parameter Value .....	26
6.4.4 Description of the System Setup Parameters .....	26
6.5 Channel Setup for Pressure Measurement.....	30
6.5.1 Overview of 946 Channel Setup .....	30
6.5.2 Setup for a Capacitance Manometer .....	32
6.5.3 Setup for a PR (Pirani)/CP (Convection Pirani) Sensor.....	35
6.5.4 Setup a Cold Cathode Sensor .....	38
6.5.5 Setup a Hot Cathode Sensor .....	41
6.6 Power Control of a Pressure Sensor.....	44
6.6.1 Power (including degas) Control of a Sensor using Front Panel Control Button .....	44
6.6.2 Power (including degas) Control of a Sensor via 37 pin AIO D-Sub Connector .....	45
6.6.3 Power (including degas) Control of a Sensor using Serial Communication Commands.....	46
6.7 Channel Setup for Flow Measurement and MFC Based Pressure Control .....	47
6.7.1 Simple Operations of a Mass Flow Controller .....	47
6.7.2 Setup MFC Controlling Parameters for Flow Control .....	48
6.7.3 Set MFC(s) for Dynamically Controlling System Pressure .....	51
6.8 Pressure Control using a Control Valve .....	62
6.8.1 Valve Type Selection .....	63
6.8.2 Valve Control Recipe Setup .....	64
6.8.3 Activate a Pressure Control using a Valve .....	64
6.8.4 Terminate a PID Pressure Control using a Valve .....	66

7	Installing Vacuum Sensors .....	68
7.1	Installing Cold Cathode Sensors .....	68
7.1.1	Locating a Cold Cathode Sensor .....	68
7.1.2	Orienting a Cold Cathode Sensor .....	68
7.1.3	Managing Contamination in a Cold Cathode Sensor .....	68
7.1.4	Connecting the Series 431/422 Sensor .....	68
7.1.5	Connecting the 423 I-MAG Sensor .....	69
7.2	Installing Hot Cathode Sensors .....	69
7.2.1	Locating a Hot Cathode Sensor .....	69
7.2.2	Preventing Contamination in a Hot Cathode Sensor .....	69
7.2.3	Orienting a Hot Cathode Sensor .....	69
7.2.4	Connecting a Hot Cathode Sensor to the Vacuum System .....	69
7.2.5	Connecting a Hot Cathode Sensor to the 946 Controller .....	70
7.3	Installing Pirani Sensors .....	71
7.3.1	Locating a Pirani Sensor .....	71
7.3.2	Preventing Contamination in a Pirani Sensor .....	71
7.3.3	Orienting the Series 317 Pirani Sensor .....	72
7.3.4	Orienting the Series 345 Pirani Sensor .....	72
7.3.5	Connecting the Series 317/345 Sensors .....	72
7.3.6	Preparing the 317 Sensor for Bakeout .....	73
7.4	Installing Capacitance Manometers - MKS Baratron .....	73
7.4.1	Installing a Baratron Capacitance Manometer .....	74
7.4.2	Connecting a Baratron™ Capacitance Manometer .....	74
7.5	Installing Mass Flow Controllers .....	75
7.5.1	Environmental requirements .....	75
7.5.2	Interface Cables .....	75
7.5.3	Setup .....	76
7.5.4	<a href="#">Gas Line Connections</a> .....	<a href="#">78</a>
7.6	Installing Pressure Control Valve .....	76
7.6.1	Installing an Upstream Solenoid Valve .....	76
7.6.2	Installing a downstream MKS 153/T3B throttle valve .....	77
8	Connecting Relay and Analog Outputs .....	79
8.1	Connecting 946 Relay Outputs .....	79
8.1.1	Pin Out for the 946 Relay Output .....	79
8.1.2	Proper Setting of a Relay .....	80
8.1.3	Relay Inductive Loads and Arc Suppression .....	81
8.2	Connecting the 946 Analog Output .....	81
8.3	Buffered Analog Output .....	82
8.4	Logarithmic/Linear and Combination Analog Output .....	93
8.4.1	Logarithmic/Linear Analog Output .....	93
8.4.2	Combination Analog Output .....	93
8.4.3	Logarithmic/Linear Analog Output when the Gauge Power is Turned Off .....	95
9	946 RS232/485 Serial Communication Commands .....	96
9.1	Serial Communication Wiring Diagram .....	96
9.2	Communication Protocols .....	96
9.3	Pressure Reading Commands .....	97
9.4	Relay and Control Setting Commands .....	98
9.5	Capacitance Manometer Control Commands .....	99
9.6	Pirani and Convection Pirani Control Commands .....	99
9.7	Cold Cathode Control Commands .....	100
9.8	Hot Cathode Control Commands .....	101

9.9	MFC Control Commands.....	102
9.10	Pressure (Valve) Control Commands .....	102
9.11	PID Recipe Setting Commands .....	103
9.12	Ratio Recipe Setting Commands .....	104
9.13	PID/Ratio Control Activation Command .....	104
9.14	System Commands .....	105
9.15	Error Code .....	107
10	Maintenance of Series 946 Controller Modules .....	108
10.1	Removing and Installing a Sensor Module.....	108
10.2	Removing and Installing AIO Module.....	108
10.3	Communication Module.....	110
10.4	Power Supply .....	110
10.5	Mounting the 946 Controller.....	111
10.6	AC Power Cord .....	112
11	Maintenance and Service of HPS® Vacuum Sensors.....	113
11.1	431 Cold Cathode Sensor .....	113
11.1.1	Cold Cathode Theory.....	113
11.1.2	Maintenance of Series 431/422 Cold Cathode Sensor.....	114
11.2	Maintenance of Series 423 I-MAG® Cold Cathode Sensor.....	117
11.2.1	Connecting the I-MAG Sensor .....	117
11.2.2	Disassembling the I-MAG Sensor.....	117
11.2.3	Cleaning the I-MAG Sensor .....	118
11.2.4	Assembling the I-MAG Sensor.....	119
11.2.5	Preparing the Sensor for Bakeout.....	120
11.3	Maintenance of Low Power Nude and Mini BA Hot Cathode Sensors.....	120
11.3.1	Hot Cathode Theory.....	120
11.3.2	Cleaning the Hot Cathode Sensor .....	121
11.3.3	Testing the Hot Cathode Sensor.....	121
11.4	Maintenance of Pirani Sensors .....	122
11.4.1	Theory of a Pirani Pressure Sensor.....	122
11.4.2	Cleaning the Series 345 Sensor .....	123
11.4.3	Cleaning the Series 317 Sensor .....	124
11.5	Theory of a Capacitance Manometer.....	125
11.5.1	Repairing the Baratron™ Capacitance Manometer.....	125
12	Spare Parts and Accessories.....	126
13	APPENDIX.....	129
13.1	Hot Cathode Gauge Gas Correction Factors .....	129
13.2	MFC Gas Conversion Factors for Selected Gases.....	131
14	Product Warranty .....	134

# Package Contents

Before unpacking the 946 high vacuum, multi-sensor system controller, check all surfaces of the packing material for shipping damage.

Please be sure that the 946 system contains the following items:

- 1 Series 946 Controller (with selected modules installed)
- 1 female, 25-pin D-sub connector for relay output connection
- 1 male, 37pin D-sub connector for analog output connection
- 1 10-foot power cord



If any items are missing from the package, call HPS® Products Customer Service Department at 1-303-449-9861 or 1-800-345-1967.

Inspect the 946 system for visible evidence of damage. If it has been damaged in shipping, notify the carrier immediately. Keep all shipping materials and packaging for claim verification. Do **not** return the product to HPS® Products.

# 1 Safety Information

## 1.1 Symbols Used in this Manual and their definitions



**CAUTION:** Risk of electrical shock.



**CAUTION:** Refer to manual. Failure to read message could result in personal injury or serious damage to the equipment or both.



**CAUTION:** Hot surface.



Calls attention to important procedure, practice, or conditions.



Failure to read message could result in damage to the equipment.

## 1.2 Safety Precautions

### 1.2.1 Safety Procedures and Precautions

The following general safety precautions must be observed during all phases of operation of this instrument. Failure to comply with these precautions or with specific warnings elsewhere in this manual violates safety standards for the intended use of the instrument and may impair the protection provided by the equipment. MKS Instruments, Inc. assumes no liability for the customer's failure to comply with these requirements.



#### **Properly ground the Controller.**

This product is grounded through the grounding conductor of the power cord. To avoid electrical shock, plug the power cord into a properly wired receptacle before connecting it to the product input or output terminals. A protective ground connection through the grounding conductor in the power cord is essential for safe operation.

Upon loss of the protective-ground connection, all accessible conductive parts (including knobs and controls that may appear to be insulating) can render an electrical shock.



#### **Do not substitute parts or modify the instrument.**

Do not install substitute parts or perform any unauthorized modification to the instrument. Return the instrument to an MKS Calibration and Service Center for service and repair to ensure that all safety features are maintained.



**Use proper electrical fittings.**

Dangerous voltages are contained within this instrument. All electrical fittings and cables must be of the type specified, and in good condition. All electrical fittings must be properly connected and grounded.



**The Series 946 Controller contains lethal voltages when on.**

High voltage is present in the cable and a Cold Cathode sensor when the Controller is turned on.



**Use the proper power source.**

This product is intended to operate from a power source that applies a voltage between the supply conductors, or between either of the supply conductors and ground, not more than that specified in the manual.



**Use the proper fuse.**

Only use a fuse of the type, voltage rating, and current rating specified for your product.



**Do not operate in explosive environment.**

To avoid explosion, do not operate this product in an explosive environment unless it has been specially certified for such operation.



**Service by qualified personnel only.**

Operating personnel must not remove instrument covers. Component replacement and internal adjustments must only be made by qualified service personnel.



**Use proper power cord.**

Only use a power cord that is in good condition and that meets the input power requirements specified in the manual.

Only use a detachable cord set with conductors having a cross-sectional area equal to or greater than 0.75 mm<sup>2</sup>. The power cable should be approved by a qualified agency such as VDE, Semko, or SEV.

## 2 Specifications<sup>1</sup>

### 2.1 Controller

#### Pressure measuring range<sup>2</sup>

1 x 10<sup>-11</sup> to 2.0 x 10<sup>+5</sup> Torr  
1 x 10<sup>-11</sup> to 2.6 x 10<sup>+5</sup> mbar  
1 x 10<sup>-9</sup> to 2.6 x 10<sup>+7</sup> Pa

#### Relay set point range<sup>3</sup>

##### CC (Cold Cathode)

2.0 x 10<sup>-10</sup> to 5.0 x 10<sup>-3</sup> Torr  
2.7 x 10<sup>-10</sup> to 6.5 x 10<sup>-3</sup> mbar  
2.7 x 10<sup>-8</sup> to 6.5 x 10<sup>-1</sup> Pa

##### HC (Hot Cathode)

5.0 x 10<sup>-10</sup> to 5.0 x 10<sup>-3</sup> Torr  
6.5 x 10<sup>-10</sup> to 6.5 x 10<sup>-3</sup> mbar  
6.5 x 10<sup>-8</sup> to 6.5 x 10<sup>-1</sup> Pa

##### Pirani

2.0 x 10<sup>-3</sup> to 9.5 x 10<sup>+1</sup> Torr  
2.7 x 10<sup>-3</sup> to 1.2 x 10<sup>+2</sup> mbar  
2.7 x 10<sup>-1</sup> to 1.2 x 10<sup>+4</sup> Pa

##### CP (Convection Pirani)

2.0 x 10<sup>-3</sup> to 9.5 x 10<sup>+2</sup> Torr  
2.7 x 10<sup>-3</sup> to 1.2 x 10<sup>+3</sup> mbar  
2.7 x 10<sup>-1</sup> to 1.2 x 10<sup>+5</sup> Pa

##### CM (Absolute Manometer)

0.2% to 100% of the measurement range of the head (e.g. 1 Torr head is 2.0 x 10<sup>-3</sup> to 1.0 x 10<sup>+0</sup> Torr)

##### CM (Differential Manometer)

-100% to 100% of the measurement range

##### FC (Mass Flow Controller)

0.2% to 100% of the measurement range of the MFC (e.g. 1000 sccm MFC is 2.0 x 10<sup>+0</sup> to 1.0 x 10<sup>+3</sup> sccm)

#### Allowed range within which a control gauge may switch on a Cold or Hot Cathode

##### Pirani

5.0 x 10<sup>-4</sup> to 9.5 x 10<sup>-1</sup> Torr  
6.5 x 10<sup>-4</sup> to 1.3 x 10<sup>-1</sup> mbar  
6.5 x 10<sup>-2</sup> to 1.3 x 10<sup>1</sup> Pa

##### CP (Convection Pirani)

2.0 x 10<sup>-3</sup> to 9.5 x 10<sup>-1</sup> Torr  
2.7 x 10<sup>-3</sup> to 1.3 x 10<sup>-1</sup> mbar  
2.7 x 10<sup>-1</sup> to 1.3 x 10<sup>1</sup> Pa

##### CM (≤2T head)

1.0 x 10<sup>-1</sup> to 0.2% of FS Torr  
1.3 x 10<sup>-1</sup> to 0.2% of FS mbar  
1.3 x 10<sup>+1</sup> to 0.2% of FS Pa

#### Protection set point<sup>4</sup>

##### CC & HC

1.0x10<sup>-5</sup> to 1.0x10<sup>-2</sup> Torr, default setting: 5.0x10<sup>-3</sup> Torr

<sup>1</sup> Design and/or specifications are subject to change without notice.

<sup>2</sup> The measurement range depends upon the sensor options selected.

<sup>3</sup> Relay set point values are automatically adjusted when pressure unit is changed.

<sup>4</sup> The protection set point is always enabled in 946.



<b>Operating temperature range</b>	5° to 40°C (41° to 104°F)
<b>Storage temperature range</b>	-10° to 55°C (14° to 131°F)
<b>Relative humidity</b>	80% maximum for temperatures less than 31°C, decreasing linearly to 50% maximum at 40°C
<b>Altitude</b>	2000 m (6561 ft) maximum
<b>Insulation coordination</b>	Installation (Over-voltage) Category II, Pollution Degree 2
<b>Power requirement (nominal)</b>	100 - 240 VAC, 50/60 Hz
<b>Mains voltage</b>	Fluctuations not to exceed ±10% of nominal
<b>Power consumption</b>	150 W maximum
<b>Fuse rating, size</b>	2X2A, 250V, Ø 5 mm x 20 mm
<b>Process control relay</b>	12 nonvolatile relays, (4 for each sensor module)
<b>Relay rating</b>	SPDT, 2 A @ 30 V resistive
<b>Relay response</b>	150 msec maximum
<b>Analog outputs<sup>5</sup></b>	One Buffered and one Logarithmic ( $V = A \times \lg(p) + B$ ) or Linear ( $V = A \times p$ ) for each channel, up to two (2) wide-range combination logarithmic outputs. Output impedance = 100 ohms
<b>Number of channels</b>	Up to 6
<b>Front panel controls</b>	Power on-off switch, setup and operational commands can be accessed via the keypad.
<b>Display</b>	320x240 color QVGA TFT LCD with back lighting.
<b>Pressure units</b>	Torr, mbar, Pascal or microns
<b>Flow units</b>	sccm ( $\leq 10,000$ sccm) and slm ( $> 10$ slm)
<b>Update rate</b>	LCD display is updated 3 times per second. The pressure/flow signals are updated every 50 msec.
<b>Sensor module slots</b>	3
<b>Sensor modules</b>	<b>channels/module</b>
Cold Cathode	single
Hot Cathode	single
Pirani/Convection Pirani	dual
Capacitance Manometer	dual
MFC	dual
<b>COMM/Control modules</b>	
Pressure Control	

---

<sup>5</sup> Logarithmic/linear and combined logarithmic analog outputs can be customized using the system setup manual. There is no logarithmic/linear and combined analog output for differential Baratron.

<b>Computer interface</b>	<i>Serial</i> – RS-232 and RS-485 9600, 19200, 38400,57600,115200 baud rate selectable
<b>Electronic casing</b>	Aluminum
<b>Dimensions (W x D x H)</b>	9½" x 12¼" x 3½" (241 mm x 311 mm x 88 mm)
<b>Size</b>	½ rack, 2U high
<b>Typical weight</b>	8.0 lb (3.6 kg)
<b>CE certification</b>	EMC Directive: 2004/108/EEC Low Voltage Directive: 73/23/EEC

## 2.2 Sensors

### Sensor type

CC (Cold Cathode)	Series 431 and 422 inverted magnetron Series 423 I-MAG®
HC (Hot Cathode)	Bayard—Alpert (BA) type ionization gauges including HPS MIG (Miniature Ionization Gauge, or LPN (Low Power Nude), glass enveloped gauges and UHV nude type.
Pirani	Series 345 Pirani
CP (Convection Pirani)	Series 317 Convection Pirani
CM (Capacitance Manometer)	MKS unheated Baratron® (622A, 623A, 626A, 722A ); MKS 45 C heated Baratron® (624B,D24B, 627B,D27B); MKS differential Baratron® (226A)
FC (Mass Flow Controller)	MKS1179A, 179A, 1479A, 1559A, 2179A, P4B, M100B, M100MB

### Pressure measurement range

CC (Cold Cathode)	1.0 x 10 <sup>-11</sup> to 1.0 x 10 <sup>-2</sup> Torr 1.3 x 10 <sup>-11</sup> to 1.3 x 10 <sup>-2</sup> mbar 1.3 x 10 <sup>-9</sup> to 1.3 x 10 <sup>+0</sup> Pa
HC (Hot Cathode)	1.0x 10 <sup>-10</sup> to 1.0 x 10 <sup>-2</sup> Torr 1.3 x 10 <sup>-10</sup> to 1.3 x 10 <sup>-2</sup> mbar 1.3 x 10 <sup>-8</sup> to 1.3 x 10 <sup>+0</sup> Pa
Pirani	5.0 x 10 <sup>-4</sup> to 4.0 x 10 <sup>+2</sup> Torr 6.5 x 10 <sup>-4</sup> to 5.2 x 10 <sup>+2</sup> mbar 6.5 x 10 <sup>-2</sup> to 5.2 x 10 <sup>+4</sup> Pa
CP (Convection Pirani)	1.0 x 10 <sup>-3</sup> to 1.0 x 10 <sup>+3</sup> Torr 1.3 x 10 <sup>-3</sup> to 1.3 x 10 <sup>+3</sup> mbar 1.3 x 10 <sup>-1</sup> to 1.3 x 10 <sup>+5</sup> Pa
CM (Capacitance Manometer)	Three decades below full scale of head, (e.g., 10 Torr head is 1.0 x 10 <sup>-2</sup> to 1.0 x 10 <sup>+1</sup> Torr)
Flow Range (MFC)	1 sccm to 1,000 slm     1

### Response time (Buffered analog output)

CC	<40 msec <sup>6</sup>
HC	<50 msec
Pirani, CP	<80 msec
CM	<40 msec

### Response time (Log/Lin analog output)

CC	<50 msec
HC	<50 msec
Pirani, CP	<80 msec
CM	<80 msec

### Resolution<sup>7</sup>

CC	2 significant digits between 10 <sup>-10</sup> and 10 <sup>-2</sup> Torr, 1 significant digit in 10 <sup>-11</sup> Torr decades
HC	2 significant digits between 10 <sup>-10</sup> and 10 <sup>-2</sup> Torr
Pirani	1 significant digit from 450 to 100 Torr; 2 significant digits between 10 <sup>-4</sup> and 100 Torr
CP	2 significant digits over the entire range.
CM & FC	4 significant digits from 10 to 100% FS, 3 significant digits from 1 to 10% FS, 2 significant digits from 0.1 to 1% FS, 1 significant digit from 0.01 to 0.1% FS.

### Repeatability

CC, HC, Pirani, CP	5% of indicated pressure at constant temperature
CM	0.25% of indicated pressure at constant temperature
FC	0.2% of full scale

### Calibration gas

CC, HC	Nitrogen, Argon
Pirani, CP	Air/nitrogen, Argon, Helium
CM	Any (gas independent)
FC	Nitrogen

### Installation orientation

CC, HC, CM, Pirani, FC	Any (port down suggested for pressure sensor)
CP	Body horizontal only

<sup>6</sup>A fast response (<3 msec) Cold Cathode board is also available. Please consult the factory for details.

<sup>7</sup> Trailing zeros displayed on LCD screen do not reflect the resolution of the pressure reading.

### Materials exposed to vacuum may include

CC	Series 431 and 422 – SS 304, Al 6061, silver-copper brazing alloy, alumina ceramic, Elgiloy®, OFHC® copper  Series 423 – SS 302, SS 304, glass, Al, Inconel X-750®, alumina ceramic
HC	304 SS, Inconel® X750, glass, tungsten, platinum clad molybdenum, tantalum, nickel, braze alloy, either yttria coated iridium or tungsten filament
Pirani	300 series stainless, platinum, glass, alumina ceramic, silver brazing alloy, nickel 200
CP	300 series stainless, nickel, glass, platinum
CM	Inconel®
FC	316 series stainless, nickel, Elgiloy®, Elastomer seal.

### Internal volume<sup>8</sup>

CC	Series 431 and 422 - 1.8 in <sup>3</sup> (30 cm <sup>3</sup> ) Series 423 - 0.9 in <sup>3</sup> (15 cm <sup>3</sup> )
HC	Low power nude tube - zero Mini BA - 1.4 in <sup>3</sup> (23 cm <sup>3</sup> )
Pirani	0.5 in <sup>3</sup> (8 cm <sup>3</sup> )
CP	2.0 in <sup>3</sup> (33 cm <sup>3</sup> )
CM	Type 622A/623A/626A - 0.38 in. <sup>3</sup> (6.3 cm <sup>3</sup> ) Type 722A - 0.3 in. <sup>3</sup> (4.9 cm <sup>3</sup> )
FC	0.27 in <sup>3</sup> (4.43 cm <sup>3</sup> )

### Operating temperature range

CC	Series 431 - 0° to 70°C (32° to 158°F) Series 422--Versions available that operate up to 250°C. Series 423 - 0° to 70°C (32° to 158°F)
Pirani & HC	0° to 50°C (32° to 122°F)
CP	10° to 50°C (50° to 122°F)
CM & FC	0° to 50°C (32° to 122°F)

### Maximum bakeout temperature (Without controller or cables)

CC	Series 431 – 250°C (482°F) when backshell subassembly removed, 125°C (257°F) otherwise Series 423 – 400°C (752°F) CF flange version only with magnet removed  Series 422- 250°C, cable removed. 250°C optional with bankable cable.
----	--

<sup>8</sup> Volume will vary with the type of vacuum connection selected

HC	60°C with cable attached 300°C max, with CF, cable removed 150°C, with KF and Viton® seal, cable removed
Pirani	50°C (122°F)
CP	100°C (212°F) RF shielded with coated plastic shell installed 150°C (302°F) Partial shell disassembly required 250°C RF shield via aluminum housing
CM & FC	N/A
<b>Hot cathode sensitivity</b>	
LPN	9 Torr <sup>-1</sup> (±20%)
Mini BA	12 Torr <sup>-1</sup> (±20%)
<b>Hot Cathode filament type</b>	
LPN	<i>Tungsten (W)</i> or <i>Yttria (Y<sub>2</sub>O<sub>3</sub>)</i> coated iridium
Mini BA	<i>Yttria (Y<sub>2</sub>O<sub>3</sub>)</i> coated iridium
<b>Hot Cathode degas power (E-beam, at grid)</b>	
LPN	20 W max
Mini BA	5 W max
<b>Ion gauge operating voltages</b>	
HC	Grid: 180 VDC (normal operation); up to 600 V during degas Filament bias: 30 VDC Filament: 1.8 VDC @ 2A
CC	4.0 kVDC
<b>Hot Cathode X-ray limit</b>	
LPN & Mini BA	3x10 <sup>-10</sup> Torr <sup>9</sup>
<b>Dimensions</b>	
CC	Series 431 and 422 – Ø2.2x6.3 in (Ø56x160 mm) Series 423 – Ø2.6x3.4 in (Ø66x86 mm)
Mini BA	Ø1.12X2.37 in (Ø28x60 mm) with 2-3/4" CF flange
LPN	Ø3.3X1.0 in (Ø83 mmx25) with 2-3/4 CF flange, can insert into NW40 tube.
Pirani	Ø1.3X4.4 in (Ø34x112 mm)
CP	Ø1.6X4.4 in (Ø41x112 mm)
CM	Types 622A, 623A and 626A - Ø2.6x4.8 in. (Ø66x121 mm) Type 722A- Ø1.5x3.9 in (Ø38x99 mm)
FC (HxWxL)	1179A -<5.5x<1.5x3 in (<14.0x<3.8x7.6 mm)

<sup>9</sup> The Hot Cathode X-ray limit can be corrected by using a serial command. See section 9.6 for details.

## Typical Weight (with 2<sup>3</sup>/<sub>4</sub>" CF Flange)

CC	431 and 422 - 2.4 lb (1.1 kg) 423 - 1.8 lb (0.8 kg)
LPN	0.9 lb (0.40 kg) with CF flange
Mini BA	0.816 lb (0.36 kg) with CF flange
Pirani	0.5 lb (0.2 kg)
CP (w/ KF Flange)	0.5 lb (0.2 kg)
FC	<1.9 lb (0.86 kg)

## Vacuum Connection

CC	431, 422, KF25, KF40, 2-3/4" CF, 8 VCR <sup>®</sup> -F (1/2"), 1" tubing 423, KF25, KF40, 2-3/4" CF, 1" tubing
LPN	2-3/4" CF (non-rotatable), KF 40
Mini BA	KF16, KF25, KF40, 2-3/4" CF, 1-1/3" mini CF, 3/4", 1" OD tubing
Pirani, CP	KF16, KF25, 1/8" NPT-M with 1/2" compression seal, 8 VCR <sup>®</sup> -F, 4 VCR <sup>®</sup> -F, 1-1/3" CF (non-rotatable), 2-3/4" CF (non-rotatable)
CM	KF16, 8 VCR <sup>®</sup> -F (1/2"), 8 VCO <sup>®</sup> -F (1/2"), 1-1/3" CF (non-rotatable), 1/2" tube

## 2.3 Controller Display

### 2.3.1 Display Message

X.X0E±ee	Normal pressure for the Pirani, CP, CC, and HC
X.XXXE±e	Normal pressure for the Baratron, flow rate for MFC
OVER	The pressure is over upper limit (for CC and HC when $p > 1 \times 10^{-2}$ Torr)
ATM	Atmospheric pressure for the Pirani sensor
>1.100E±e	CM pressure is over 10% of the full scale
LO<E-11	The CC pressure is below its lower limit, or no CC gauge is connected
LO<E-10	The HC pressure is below its lower limit
LO<E-04	The Pirani pressure is below its lower limit
LO<E-03	The CP pressure is below its lower limit
OFF	Power is off to HC/CC/CP/PR sensor.
WAIT	CC and HC startup delay
Low EMIS	The HC off due to low emission current
CTRL OFF	The HC or CC are turned off by the control channel

PROT OFF	The HC or CC are in a protected state
RP OFF	The sensor power is turned off remotely
REDETECT	Detecting the sensor type for PR/CP
----	No Pirani/CP/HC/MFC sensor is detected on the inserted Pirani/CP board
NOBOARD	No board is detected in the slot, display only last 5 secs
N2, AR, He	Gas type
U	User calibration
SPn	Activated relay channel (n=1 to 12)
--	A relay is enabled, but not activated.
Ctrl	The CC/HC is controlled by another gauge (PR/CP)
AZ	PR/CP/BR may be auto-zeroed by its control gauge
F1, F2	Active filament
DG	The HC is degassing
An, Bn, Cn	The channel where the control gauge is installed (n=1, 2)

### 2.3.2 Display Resolutions

The pressure values displayed on a 946 Vacuum System Controller front panel varies with the type of gauge being connected, and range of measured pressure. In addition, three display formats are available: Default, HighR<sup>10</sup> (high resolution), and PatchZ (patch zero) and can be selected based on customer's preference.

	PatchZ	Default/HighR
Percentage of Full-Scale	Displayed Resolution	Displayed Resolution
>110% FS	>(110%*FS value)	>(110%*FS value)
110% to 10%	X.XXXE+X	X.XXXE+X
10% to 1%	X.XX0E+X	X.XXE+X
1% to 0.1%	X.X00E+X	X.XE+X
<0.1%	X.000E+X	XE+X

**Table 2-1<sup>11</sup> Capacitance Manometer with Exponential Display Format**

Table 2-1<sup>11</sup> shows the exponential display format for Capacitance Manometer. If the Capacitance Manometer measurement range is between 10<sup>4</sup> and 10 (regardless of pressure unit), one can toggle the

decimal and exponential display format by pressing the  button on the CM channel highlighted by the LED indicator on the 946 front panel.

<sup>10</sup> When HighR mode is selected, the controller displays extra digit for ion gauge pressure to assist the monitoring of pressure changes.

<sup>11</sup> One less digit will be displayed when a differential Capacitance Manometer reports a negative differential pressure reading as a negative sign will be displayed.

Pressure Range	Convection Pirani		Pirani		Hot Cathode			Cold Cathode			
	Torr	PatchZ	Default HighR	PatchZ	Default HighR	PatchZ	Default	HighR	PatchZ	Default	HighR
10 <sup>3</sup>	X.X0E+03	X.XE+03	ATM	ATM							
10 <sup>2</sup>	X.X0E+02	X.XE+02	X.00E+02 (X=1,2,3,4)	X.XE+02							
10	X.X0E+01	X.XE+01	X.X0E+01	X.XE+01							
1	X.X0E+00	X.XE+00	X.X0E+00	X.XE+00							
10 <sup>-1</sup>	X.X0E-01	X.XE-01	X.X0E-01	X.XE-01							
10 <sup>-2</sup>	X.X0E-02	X.XE-02	X.X0E-02	X.XE-02	X.X0E-02	XE-02	X.XE-02	X.X0E-02	XE-02	X.XE-02	
10 <sup>-3</sup>	X.X0E-03	X.XE-03	X.X0E-03	X.XE-03	X.X0E-03	X.XE-03	X.XE-03	X.X0E-03	X.XE-03	X.XE-03	X.XE-03
10 <sup>-4</sup>	LO<E-03	LO<E-03	X.X0E-04 (X.X down to 1.3)	X.XE-04 (>5.0E-04)	X.X0E-04	X.XE-04	X.XE-04	X.X0E-04	X.XE-04	X.XE-04	X.XE-04
10 <sup>-5</sup>			LO<E-04	LO<E-04	X.X0E-05	X.XE-05	X.XE-05	X.X0E-05	X.XE-05	X.XE-05	X.XE-05
10 <sup>-6</sup>					X.X0E-06	X.XE-06	X.XE-06	X.X0E-06	X.XE-06	X.XE-06	X.XE-06
10 <sup>-7</sup>					X.X0E-07	X.XE-07	X.XE-07	X.X0E-07	X.XE-07	X.XE-07	X.XE-07
10 <sup>-8</sup>					X.X0E-08	X.XE-08	X.XE-08	X.X0E-08	X.XE-08	X.XE-08	X.XE-08
10 <sup>-9</sup>					X.X0E-09	X.XE-09	X.XE-09	X.X0E-09	X.XE-09	X.XE-09	X.XE-09
10 <sup>-10</sup>					X.00E-10	XE-10	XE-10	X.X0E-10	X.XE-10	X.XE-10	X.XE-10
10 <sup>-11</sup>								X.00E-11	XE-11	XE-11	XE-11

**Table 2-2 946 Pressure Display Format for Indirect Gauges including CP, PR, CC and HC**

Table 2-2 shows that display format for indirect gauge including Pirani, Convectional Pirani, Cold Cathode and Hot Cathode gauges. Please refer §6.4 for setting up the display format properly.

### 2.3.3 Serial Communication Response Format

CM and Piezo	Diff Baratron	Pirani	Convection	Hot Cathode	Cold Cathode
X.XXXE+X	X.XXXE+X	X.XXE-XX	X.XXE-XX	X.XXE-XX	X.XXE-XX
	-X.XXE+X				

**Table 2-3 946 Serial Communication Response Format**

Table 2-3 shows the serial communication (RS232/485) response format. In order to keep the communication response string length consistent, 0 will be patched if needed.



### 3 Feature, Control Locations and Dimensions

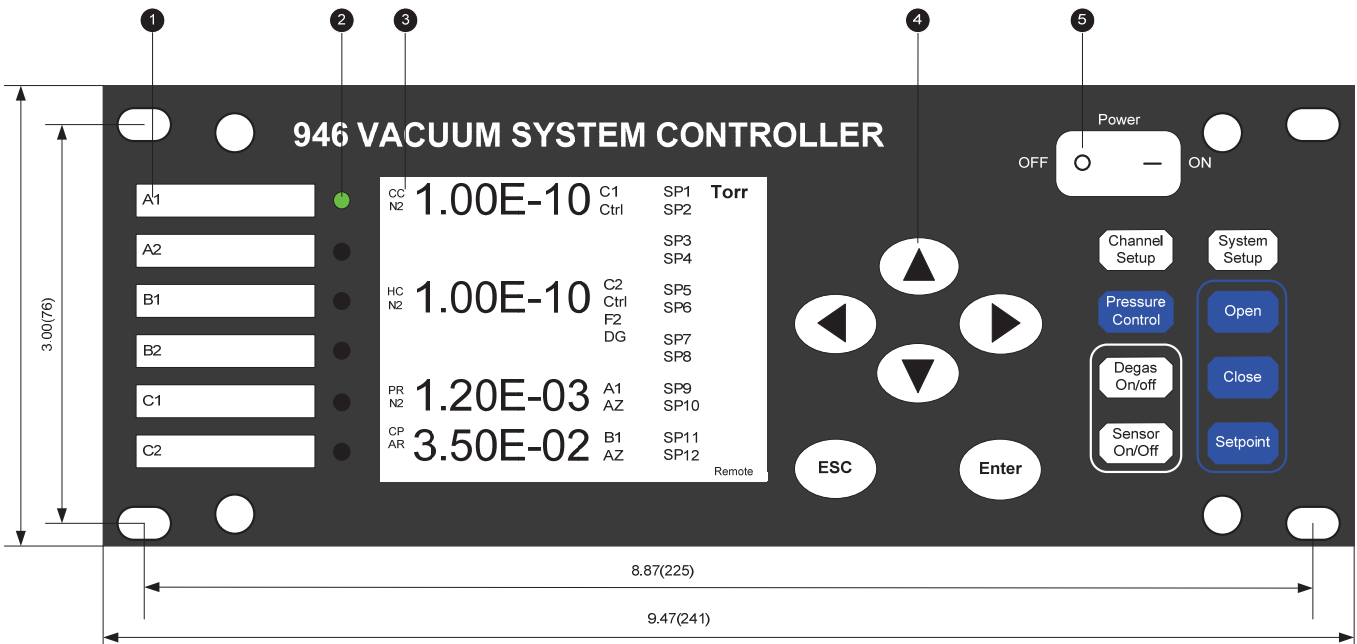

Figure 3-1 946 Front Panel

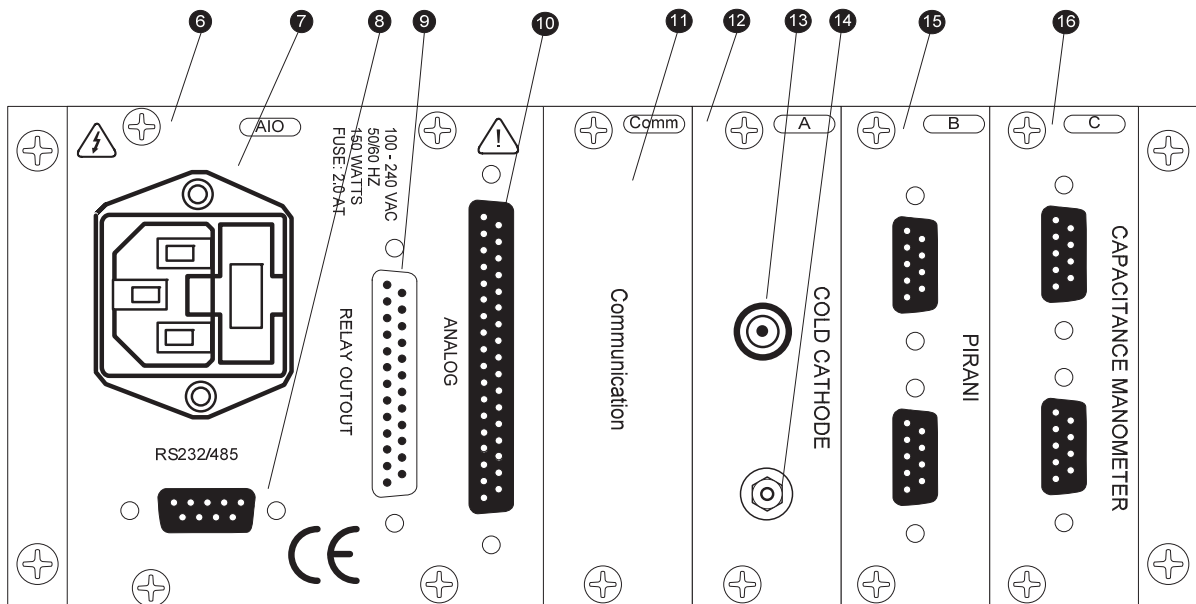

Figure 3-2 946 Rear Panel

- ① Channel Label
- ② LED, Indicating Active Channel
- ③ Liquid Crystal Display
- ④ Push Buttons for Menu Navigation
- ⑤ Power Switch
- ⑥ AIO Module
- ⑦ AC Power Inlet
- ⑧ RS232/485 Communication Port
- ⑨ Relay Output Port
- ⑩ Analog Output Port
- ⑪ Communication/Valve Control Module
- ⑫ Cold Cathode Module
- ⑬ High Voltage BNC Connector
- ⑭ Current BNC Connector
- ⑮ Pirani Module, MFC Module
- ⑯ Capacitance Manometer Module

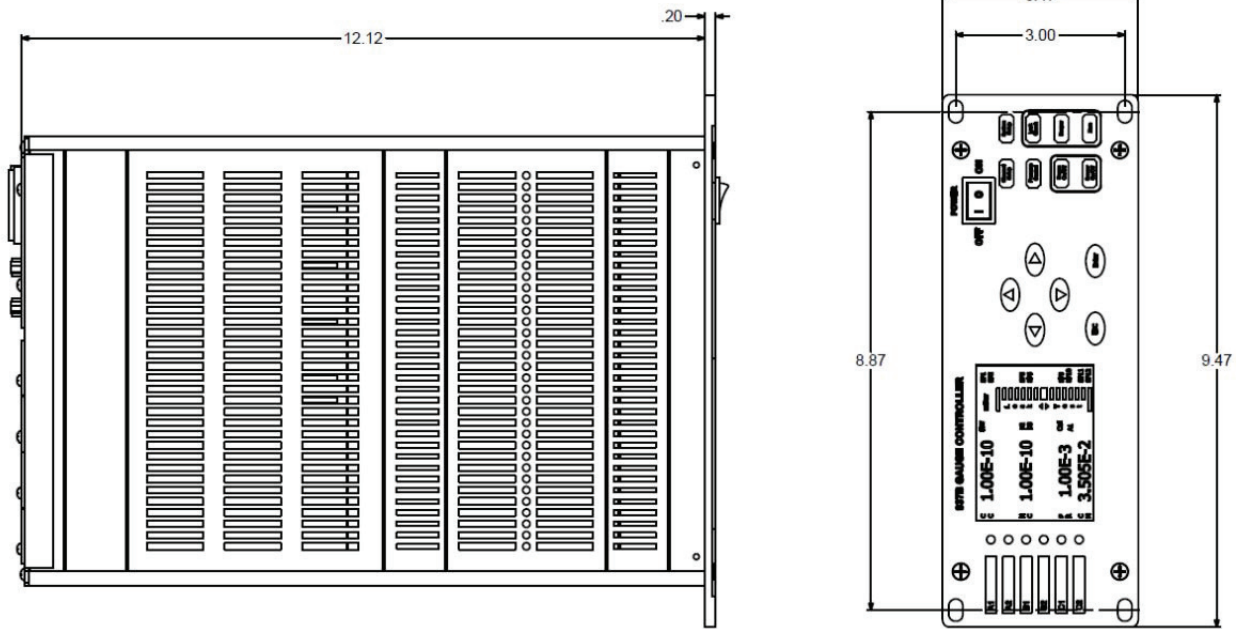

Figure 3-3 946 External Dimensions (inches)

## 4 Typical Applications for the Series 946 Controller

- The measurement of wide pressure range in vacuum chambers.
- Pressure control in vacuum systems and process sequencing using relay set points.
- Sensing abnormal pressure events and initiating and controlling appropriate security measures using the relay set points.
- Controlling system pressure by using the analog output as the input to an automatic pressure controller.
- Starting or stopping system processes using relay set points.
- Measuring backfill pressures.
- Controlling acceleration and light source vacuum systems.
- Displaying the flow rates from MFCs, and providing an interface for controlling the MFCs.
- Control of gas flow into vacuum/process chamber.
- Maintaining accurate system pressure by controlling an upstream solenoid valve .
- Maintaining accurate system pressure by controlling a downstream throttle valve.
- Maintaining accurate system pressure by regulating a single MFC flow rate (single MFC PID control), or multiple MFC flow rates with fixed ratio (ratio control).
- Maintaining smooth control of a wide range of pressures through the use of the combined analog outputs of up to 3 vacuum gauges.
- Using averaged analog output from multiple Capacitance Manometers (up to 3) with same ranges for critical process control.
- Using fast relay control signal associated with Cold Cathode gauge for high vacuum protection.
- Integrated vacuum process control with simultaneous flow, pressure, and valve control.

## 5 HPS® Products Series 946 Vacuum System Controller

THE HPS® PRODUCTS SERIES 946 Vacuum System Controller provides accurate and reliable pressure measurement between  $1 \times 10^{-11}$  Torr to  $2 \times 10^{+5}$  Torr, measurement and control of mass flow rate, and control of system pressure in different ways (single channel MFC PID control, multiple MFC ratio control, upstream solenoid valve control, or downstream Throttle Valve control). A number of different MKS pressure sensors, mass flow controller/meters and control valves, listed below can be connected to the 946:

- MKS Baratron Capacitance Manometers with heads from 0.02 to 10,000 Torr (up to 6)
- MKS 423 I-MAG or Series 431/422 Cold Cathode Sensors (up to 3)
- MKS Lower Power Nude gauge or Mini BA Hot Cathode sensors (up to 3)
- MKS Series 345 Pirani sensors (up to 6)
- MKS Series 317 Convection Pirani sensors (up to 6)
- MKS1179A, 1479A, 1559A, 2179A, P4M, M100B Mass Flow Controllers (up to 6)
- MKS 179A, M100MB Mass Flow Meters (up to 6)
- MKS 148, 248, and 154 upstream Solenoid Control Valves (1)
- MKS 153/T3B downstream Throttle Valves (1)



Figure 5-1 946 Front View

With three sensor module slots available and the ability to configure a variety of sensor combinations, the Series 946 Vacuum System Controller can accommodate many unique requirements and applications. It is designed with versatility and ease-of-use in mind, with a large LCD screen that displays much useful information, including:

- Pressure measurements for all sensors connected to the controller (up to 6)
- Easy operation of MFC and valve via the front panel (Open, Close, and Set point)
- Units of the indicated pressures (Torr, mbar, Pa, microns) and flow rate (sccm, and slm, automatically selected by the controller)
- The type of pressure and flow sensor (CM, CC, PR, CP, HC, FC) (self-detecting)
- Mass flow rates for all MFCs connected to the controller (up to 6)
- Relay status (both enabled and activated relays are displayed)
- Pressure control status, including the control valve position
- The operating status of Hot Cathode gauge (active filament, degas)
- The control status of Ion gauges
- The auto zero channel for Pirani/CP/CM sensors
- Position of valve opening
- System self-checking information (board status, sensor status, pressure range, and etc.)
- Front panel locking status (when REMOTE is displayed, the front panel is locked remotely)

Controller operation is very simple. For example, to access the system setup screen, simply push the System Setup button. This permits single-screen access and adjustment for all of the control and display parameters for each sensor connected to the controller. An LED indicates the current active channel and all of the parameters associated with the sensors are displayed by pushing the Channel Setup button.

In addition to the pressure values displayed on the screen, three types of analog signals are also shown:

- Buffered analog outputs for each sensor (up to 6). These buffered analog signals respond immediately to sensor signal changes, therefore, can be used in critical fast control applications.
- Logarithmic/linear analog outputs for each pressure sensor (up to 6) ranging from 0 to 10 V. The scale for these analog outputs can be adjusted as desired. While these linear signals are somewhat simpler to deal with than the sensor-dependent buffered analog signals, there is a longer time delay (<100 msec) due to the signal processing required by the microprocessor.
- There are also combined logarithmic analog outputs (up to 2) available. By combining the sensors with different measurement ranges (such as Pirani and Cold Cathode sensors), analog signals with much wider range are available. This eliminates the requirement for switching/selecting the sensor. The time delay for these analog outputs is around 100 msec.

Twelve (12) mechanical relays with independently adjustable controller relay set points allow the 946 to control the operation of critical components in a vacuum system such as valve or a pump. The set point parameters are nonvolatile, remaining unchanged after powering down or during a power failure. They may be set or disabled from either the front panel or the optional communications module.

The Controller also has control set points to turn off Ion gauges at higher pressures, extending the operating lifetime before maintenance is required (for both Cold Cathode or Hot Cathode).

Direct computer communication is available to control front panel functions or read pressure and other information remotely. A RS232/485 serial port is available and the communication protocol can be selected from the System Setup panel.

## 6 Operating the Series 946 Controller

### 6.1 Power

946 Vacuum System Controller can be powered by universal AC voltage (100 to 240 V, 50/60 Hz). The power can be switched on and off using the *Power* switch on the front panel to *Off*. It is recommended to power off the controller when the Series 946 Controller is not in use.

### 6.2 Front Panel Control Lock

All front panel keys can be made inactive when the controller's front panel controls are locked. **REMOTE** is displayed at bottom right corner of the LCD display.

Simultaneously press ◀ and ▶ to lock or unlock the front panel controls or to display the lock status. This will toggle the lock and unlock function.

The front panel can also be locked or unlocked with optional serial communications commands. See *RS232/RS485 Communications Commands* for more information.

### 6.3 Front Panel Display

#### 6.3.1 Standard Front Panel Display

A 3.6 inch 320x240 pixel color LCD displays the pressure, control, relay, gauge type, and other critical information.

A label on the left-hand side of the front displays identifies the name of the channel (A1, A2, B1, B2, C1, C2). An illuminated green LED is used to show the active channel for channel setting purpose. The standard front panel display for the 946 is shown in Figure 6-1:

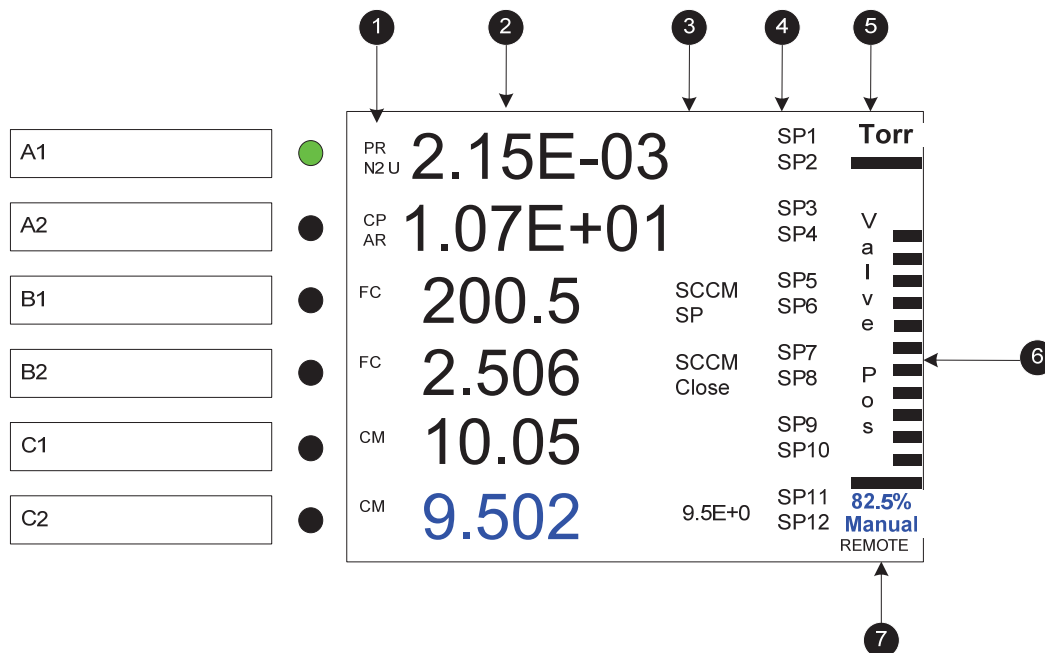

Figure 6-1-A

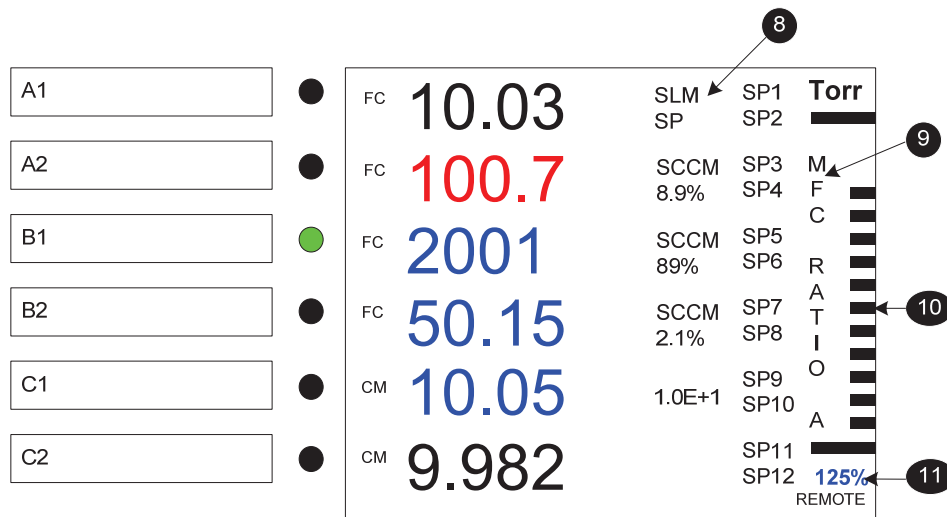

Figure 6-1-B

Figure 6-1 Standard 946 LCD Front Panel Display for Pressure Measurement (Figure 6-1-A) Valve Pressure Control Mode; (Figure 6-1-B) MFC Ratio Control Mode.

- 1 Type of sensor detected (CC = Cold Cathode, HC = Hot Cathode, PR = Pirani, CP = Convection Pirani, CM = Capacitance Manometer, FC = Mass Flow Controller, N2, AR, He = Gas type, U = User Calibrated)
- 2 Pressure/flow readings for all of the detected sensors.
- 3 Control information which includes:
  - For a Cold Cathode gauge, C1 Ctrl means the Cold Cathode gauge is controlled by channel C1.
  - For a Hot Cathode gauge, C2 Ctrl means the Hot Cathode gauge is controlled by channel C2. F2 means filament 2 is the active filament, DG means the gauge is degassing.
  - For PR/CP/CM, A1 AZ means the PR/CP/CM will be auto-zeroed by the gauge on Channel A1 (typically, an ion gauge).
  - For MFC, SCCM/SLM represents the flow units, Open/Close/SP is the valve status, 89% is the gas concentration under ratio control, 9.5E+0 is the pressure set point for valve control, and 1.0E+1 is the pressure set point for ratio control.
- 4 Relay status: displayed channel = activated relay; ---- = enabled, but, not activated relay; blank = relay is not yet set.
- 5 Pressure units (Torr, Pascal, mBar, Microns)
- 6 Valve position while using valve for pressure control.
- 7 Front screen is locked when REMOTE is displayed
- 8 Unit of flow rate, either SCCM or SLM. The unit switches to SLM automatically when the flow full scale is greater than 10SLM.
- 9 Control mode: MFC Ratio A, MFC Ratio M, Valve Position
- 10 Graphic indication of Ratio control status for ratio control using multiple MFCs.
- 11 Digital indication of control parameter

Under the Ratio control mode, the MFC flow rate will show in blue color when its value is within  $\pm 20\%$  of the set point value (corresponding to the ratio control parameter, also in blue, at right bottom corner of the display] and will show in red color when it is outside the  $\pm 20\%$  of the set point value.



**Capacitance Manometer pressure indication can be toggled between the decimal and scientific indication on the selected channel (highlighted by the green LED) by pressing**



**button.**

### 6.3.2 Large Font Displays

A special large font pressure display (only for one single channel) is also available to ensure the pressure readings can be seen in distance. To enter this mode:

1. While in the standard display mode, press either the  $\blacktriangle$  or the  $\blacktriangledown$  key to select the desired channel, as indicated by the green LED.
2. Enter the large font display mode by pressing the **Enter** key.
3. To exit the large font display mode, press the **ESC** key or the **Enter** key again.

Figure 6-2 shows a comparison between pressure measurements in the standard mode front panel display and in the large font display mode. When the large font display is selected, one channel is displayed as large font (B1 as shown in the figure) and the pressure readings for all the detected sensors are displayed in smaller font of the left side of the LCD.

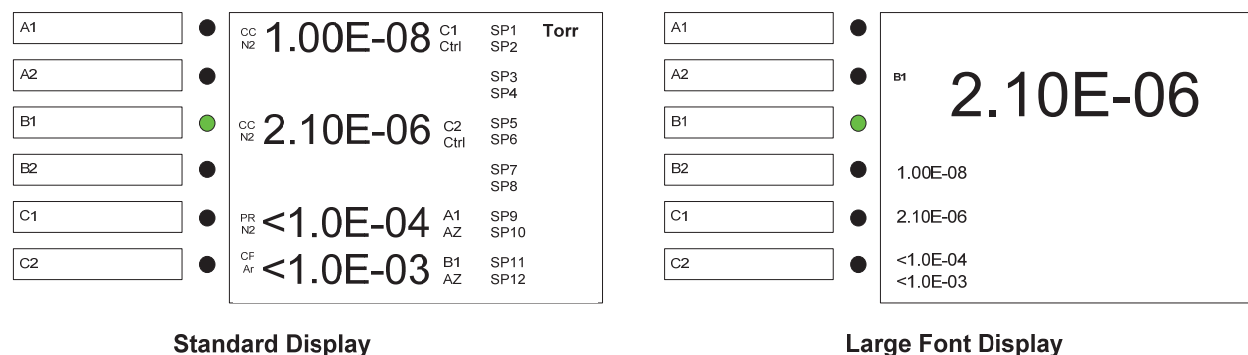

**Figure 6-2 A Comparison Between Standard Display Mode and Large Font Display Mode for the 946 LCD Display (a) During Pressure Measurement.**

### 6.3.3 LCD Screen Saver

The LCD display can be operated under sleep mode to extend the screen life when the Screen Saver mode is activated. The time delay for activating the sleep mode is from 1 to 240 minutes. The screen will be turned on when any of the key on front panel is pressed.

## 6.4 System Setup

### 6.4.1 Overview of 946 System Setup

An overview of the 946 system setup parameters is shown in Figure 6-3. The default values and the selection ranges for these parameters are also shown.

The system setup allows the user to set parameters such as pressure unit, communication protocol, communication address, baud rate, disable/enable set parameter, disable/enable user calibration, define PID control and MFC ratio control recipes, activate/deactivate screen saver, and check FW versions for the controller and boards in the controller box.



In addition, the logarithmic/linear analog output for individual channel and combined logarithmic analog output can be adjusted by setting the DAC parameters.

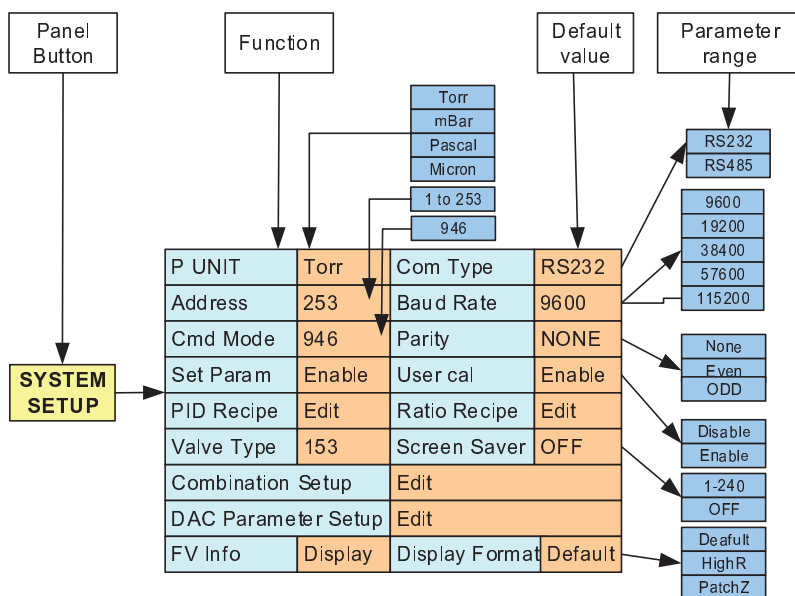



Figure 6-3 946 System Setup Parameters, their Default Values and Ranges

### 6.4.2 Display System Setup Parameters

To display the 946 system setup, press the  key; the LCD screen display will switch to the system setup mode, as shown in Figure 6-4. The shaded area in the figure shows the cursor position. The cursor position is controlled by the arrow keys on the front panel. A parameter indicated in red indicates that the value has been modified, but not yet saved.

System Setup			
P Unit	Torr	CommType	RS232
Address	253	Baud Rate	9600
Com Mode	946	Parity	None
Set Param	Enable	User Cal	Enable
PID Recipe	Edit	Ratio Recipe	Edit
Valve Type	148	Screen Saver	25
Combination Setup	Edit		
DAC Parameter Setup	Edit		
FV Info	Display	Display Format	Default













Figure 6-4 System Setup Information Displayed on 946 LCD Screen



When a parameter value is indicated in red, it means that this value has been changed, but not yet saved. Exiting the setup mode without performing a save will cause the previous, unchanged parameter value to be used.

### 6.4.3 Change and Save a Parameter Value

To change and save a system setup parameter value, use the following procedure:

1. Press any of the     keys to move the cursor to the parameter to be changed.
2. Press the  key to highlight this parameter value. For example, **Torr** will change to **Torr**.
3. Press either  or  key to change the parameter value (i.e. to change **Pascal** to **mBar**).
4. Pressing the  key at this point will restore the original parameter; pressing  or  will move the cursor away from this parameter, changing the color of the parameter value to red and it will not be saved.
5. To save an updated value, press the  key while the background of the parameter value is black (i.e. **Pascal** in this example). After  is pressed, the background of the selected parameter will turn gray (**Pascal** in this example). This indicates that the new pressure unit has been saved.
6. To return to the normal front panel display mode, press the  key once after the parameter values have been changed.



The above procedure for changing a pressure unit applies equally to changing all other parameters within the 946.

### 6.4.4 Description of the System Setup Parameters

#### 1. Pressure Unit

This determines the units used for the pressure displayed on the front panel, the pressure queried from serial communication, and the pressure set point. There are four choices: Torr, mBar, Pascal, and Microns. The default value is Torr.

#### 2. Communication Type

This sets the Serial communication protocol, either RS232 or RS485. Default value is RS232.

When the serial communication protocol is changed, the power of the 946 controller must be reset for the change to take effect.

#### 3. Address

This is the address for RS485 and RS232 communication. The valid range is from 1 to 253. The default value is 253. 254 is reserved for broadcasting only.

#### 4. Baud Rate

This sets the baud rate for serial communication. Valid values are 9600, 19200, 38400, 57600, 115200. The default value is 9600.

#### 5. Command Mode

Display the communication mode for the controller. Only 946 will be displayed.

#### 6. Parity

Define the parity for serial communication protocol. Valid values are NONE, EVEN and ODD. The default setting is NONE.



When the serial communication protocol is changed, the power of the 946 controller must be reset for the change to take effect.

#### 7. Set Parameter

When Set Parameter is disabled, none of the channel setup commands can be executed. However, these values can still be viewed from the display, or queried using serial communication:

CC	Gas Type User Calibration AO Delay Protect Set Point Relay Direction, Set Point and Hysteresis Control Set Point Channel, Set Point and Hysteresis
HC	Gas Type Degas Time Active Filament Emission Current Protect Set Point Relay Set Point, Direction and Hysteresis Control Set Point Channel, Set Point and Hysteresis
PR/CP	Gas Type Factory Default Auto Zero Manual Zero ATM Value and Calibration Relay Set Point, Direction and Hysteresis
CM & FC	Range Factory Default Auto Zero Manual Zero Relay Set Point, Direction and Hysteresis

#### 8. User Calibration

When User Calibration is disabled, the following commands cannot be executed through the keypad or through serial communications:

CC	User Calibration
HC	User Calibration and Sensitivity
PR/CP	Factory Default, Manual Zero, and Manual ATM

## 9. PID Recipe

This is used to define the recipe for PID pressure control, including pressure control in single MFC, ratio control using multiple MFCs, upstream pressure control using Solenoid Control Valve, and downstream pressure control using Throttle Valve. Up to 8 recipes can be defined for PID control. See section 6.7 and 6.8 for more detailed PID recipe setup.

## 10. Ratio Recipe

This is used to define the ratio recipe for ratio PID control of system pressure. Up to 4 ratio recipes can be defined for 946. See section 6.7 for more detailed ratio recipe setup.

## 11. Valve type

There several types of MKS valves (148, 248, 153/T3B, 154) that can be connected to 946 to control the system pressure. Valve type allows one to select the appropriate valve for vacuum system pressure control using either upstream Solenoid Valve, or downstream Throttle Valve.

## 12. Screen Saver

Screen saver allows to turn off the front panel display, therefore, to extend the service life of the LCD screen. The front panel display can be re-activated by pressing any button on the 946 front panel. The value of the screen saver means the time in minute (1 to 240 minutes) when the screen saver is activated. To disable this function, just set the value to zero.



## 13. Combination Setup

There are two combination channels available in the 946. Up to 3 vacuum pressure sensors can be assigned to each combination channel.

To view or change the combination channel settings, set the Set Combination Ch parameter to ON and press . Refer to section 8.4 for a more detailed discussion of the settings for the combination channels.

## 14. Set DAC Parameter

The Log/Linear analog output for each individual channel, as well as the combination analog output can be accessed by adjusting the DAC parameter. To view or modify the DAC parameter,

press  and move the cursor to Set DAC Parameter. Select ON and press  on the System Setup screen and the parameters used in determining the DAC logarithmic/linear analog output are displayed. These parameters can be modified, as shown in Figure 6-5.

Both slope A and offset B must be selected when a logarithmic linear equation is used. The slope A is the voltage per decade, and the offset B is the desired voltage when the measured pressure is equal to 1 Torr. The valid range for A is from 0.5 to 5, while the valid range for B is from -20 to 20 V. The default settings are 0.6 and 7.2 for A and B, respectively. If only one sensor is allowed to be connected to the board (such as HC of single channel CC), only one equation is displayed (i.e. A1, as shown in Figure 6.6).

Linearized analog output can be used when high analog output resolution is required over a narrow pressure range. When linear equation is used, the parameter B is always set to zero as it indicates zero voltage output at high vacuum. The A value can be calculated using the equation below:

$$A = \frac{10}{P_{max}}$$

Here,  $P_{max}$  is the maximum pressure (or the flow rate for an MFC) when 946 analog output voltage is at 10 V. For a Capacitance Manometer, the full range of the Manometer is normally selected for  $P_{max}$ . For example, if a 1000 Torr manometer is connected ( $P_{max}=1000$ ),  $1 \times 10^{-2}$  should be selected for A, while for a 20 sccm MFC ( $P_{max}=20$ ),  $5 \times 10^{-1}$  should be used. For other types of gauges (such as CC, HC, PR, CP), linear analog output can be used to magnify the analog out over a special range. For example, if one is interested in the pressure range from 10 to  $10^{-1}$  Torr range ( $P_{max}=10$ ), a value of 1 can be selected for A which results in 10 V analog output at 10 Torr.

Set DAC Parameter		(P unit is torr in Eq)	
	Equation	A	B
Channel A1	$V=A \log P+B$	6.00E-1	7.20E+0
Channel A2			
Channel B1	$V=AP$	1.00E+2	
Channel B2	$V=A \log P+B$	6.00E-1	7.20E+0
Channel C1	$V=A \log P+B$	6.00E-1	7.20E+0
Channel C2	$V=AP$	1.00E+3	
Combined	$V=A \log P+B$	6.00E-1	7.20E+0

Figure 6-5 Setting DAC Logarithmic and Linear Analog Output <sup>11</sup>

When select the A from the front panel of 946, only multiples of 1, 2, and 5 are allowed. Following is some examples for A corresponding to  $P_{max}$ .

$P_{max}$	$1 \times 10^{-3}$	$2 \times 10^{-3}$	$5 \times 10^{-3}$	$1 \times 10^{-2}$	$1 \times 10^2$	$2 \times 10^2$	$5 \times 10^2$	$1 \times 10^3$	$1.5 \times 10^3$
A	1E+4	5E+3	2E+3	1E+3	1E-1	5E-2	2E-2	1E-2	8.4E-3



If one expects 10V analog output at a pressure different from as stated above, it can be entered via serial communication. For example, 10V analog output is desired at 1000 mbar for Channel B1, the following serial command can be used: @254DLA3!1.33E-2;FF, here 3 after DLA is corresponding to the 3<sup>rd</sup> channel (B1) in the controller.



Since the measurement ranges for Baratron and MFC may vary significantly, please pay attention in selecting the DAC parameters to ensure proper Log/linear analog voltage output from the 946.

## 15. FV (firmware version) Information

<sup>11</sup> In order to keep the analog output unaffected by the pressure unit change, the pressure unit in these equations is fixed to Torr.

The system firmware information for all of the modules installed in the 946 is displayed when ON is selected. The serial numbers for all detected boards are also displayed, as shown in Figure 6-6.

Slot A	CC	1.00	1102114509
Slot B	CM	1.00	1103104503
Slot C	PR	1.00	1105083309
Analog IO	AIO	1.00	1101154102
Comm	Com	1.00	1102104501
Main	Main	1.00	1106031428

Detected board	Firmware Version	Serial Number
----------------	------------------	---------------

Figure 6-6 System Firmware and Serial Number Information Displayed on 946 LCD Screen

## 6.5 Channel Setup for Pressure Measurement

### 6.5.1 Overview of 946 Channel Setup

Simple and convenient setting of the parameters associated with the sensor connected to the 946 controller (such as calibration, gas selection, relay set point, control set point, and control channel selection) can be performed using Channel Setup.

Figure 6-7 shows the channel setup parameters for all of the sensors connected to a 946 controller. The default values are shown in the brown boxes while the ranges for setup are shown in the blue boxes.

To perform a Channel Setup:

- Select the desired channel by pressing either ▲ or ▼ on the front panel until the green LED on the left side of the front panel is aligned with the desired channel, as indicated on the LCD screen.
- Once the channel (sensor) is selected, the channel setup panel can be displayed by pressing . The ◀ ▶ ▲ ▼ keys are used to select the parameter to be changed.
- Press to highlight the parameter value, then press either ▲ or ▼ to change the parameter value.
- Press to save the setting.

An overview of the 946 Channel Setup options is shown in Figure 6-7. There are five types of sensor setup interfaces available. All of the variable parameters associated with the vacuum sensors, along with the ranges for these parameters are summarized in the Figure. The type of sensor is automatically detected when the key is pressed and the corresponding interface will be displayed; no manual selection is required.

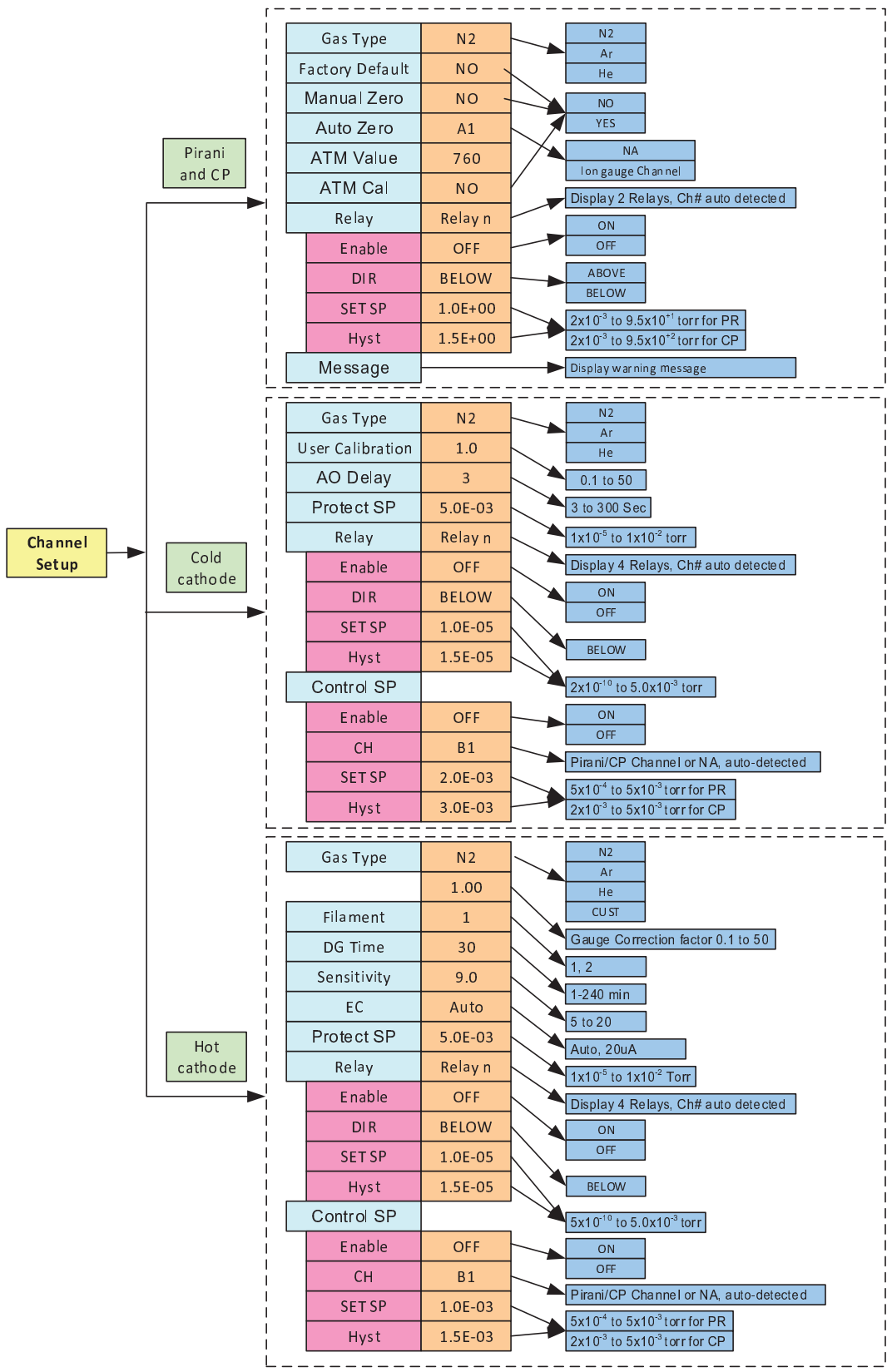

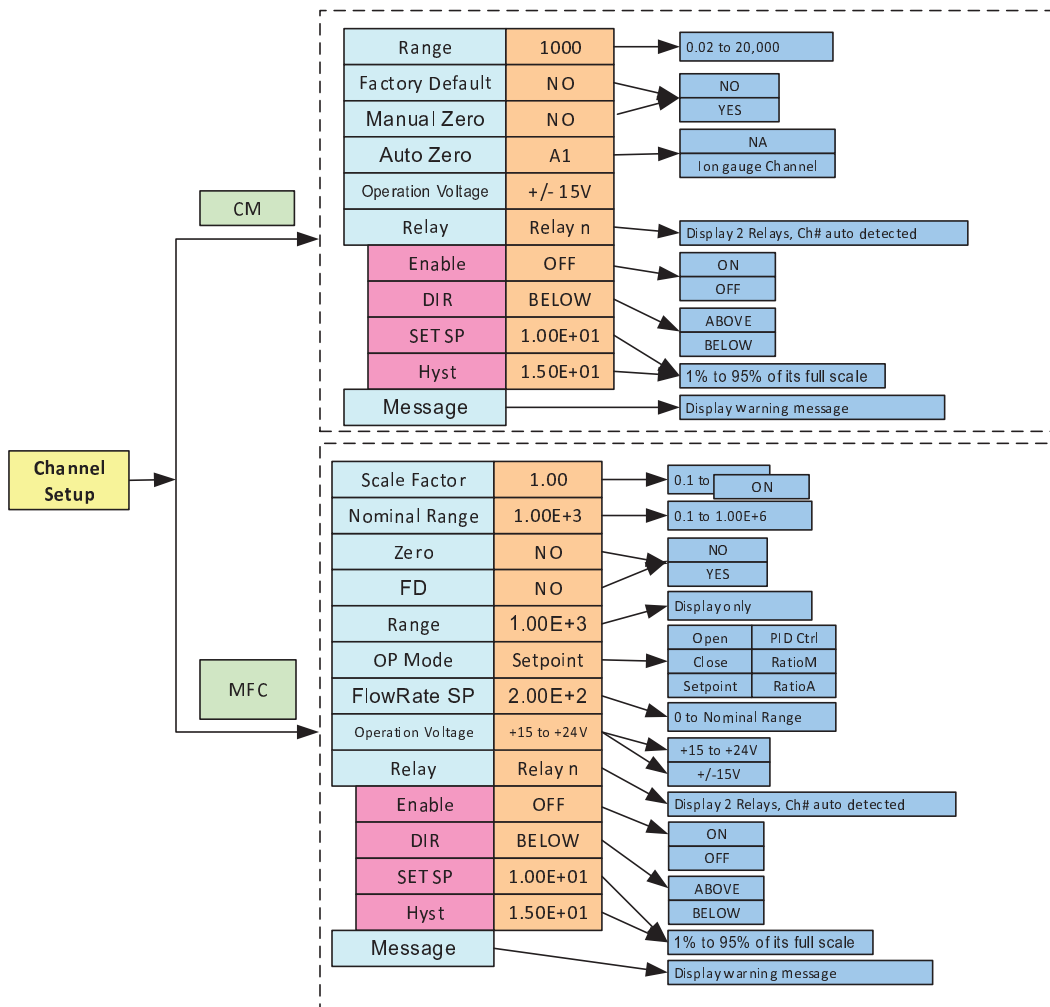

Figure 6-7 946 Channel Setup Setting Parameters, their Default Values and Ranges

## 6.5.2 Setup for a Capacitance Manometer

A Capacitance Manometer board present in the 946 controller will be automatically detected and displayed on power-up. At the same time, the connection of the Capacitance Manometer to the control board will be checked. If no Capacitance Manometer is connected, - - - will be displayed.

Refer to Figure 6-8 in setting up a Capacitance Manometer.

### 1. CM Type

ABS (absolute) and DIFF (differential) Capacitance Manometer can be selected.

### 2. Input Voltage

The Input Voltage (for the 946 controller) is same as the maximum analog output voltage of the capacitance manometer. To select the correct value, move the cursor to the Input Voltage box, press **Enter**, and this parameter will be highlighted. Use either **▲** or **▼** to select the correct voltage. Press **Enter** to save the correct setting. The valid input voltage ranges for an absolute Capacitance Manometer are 10 and 5 V. The default value is 10 V.



The valid input voltage ranges for a differential Capacitance Manometer are 1B V, 5B V, 1U V, 5U V, and 10U V. Here, B represents bi-directional (for example, 1B means  $\pm 1$  V input voltage, and the voltage at zero differential pressure is 0 V), and U represents uni-directional (for example, 10U means 0 to 10 V input voltage, and voltage at zero differential pressure is 5 V, exactly at the middle of the input range). For absolute Capacitance Manometer, valid parameters are 5 and 10V.

### 3. Range

This parameter is the full-scale pressure range of the Capacitance Manometer. Valid ranges are from  $1 \times 10^{-2}$  to  $1 \times 10^{+4}$  Torr; the default setting is 1000 Torr. Only 3 sections are available in each decade (1, 2, and 5), except between 1,000 to 10,000 Torr where 1500 Torr is allowed.

For Manometer with pressure unit other than Torr (such as 1000 mBar full scale), one needs to change the controller pressure unit to match the unit of the Manometer (such as mBar) before select the appropriate range value.

Setup CM Gauge **A1** ← Auto-detected

CM Type	DIFF	Input Voltage	5U V	
Range	1.00E+03	Factory Default	NO	
Auto Zero	NA	Manual Zero	NO	
Operation Voltage:		+/-15V		
← Message Box				
Relay	Enable	DIR	SET SP	Hyst
Relay <b>01</b>	SET	ABOVE	1.00E+01	9.35E+00
Relay <b>02</b>	ENABLE	BELOW	3.00E+01	5.35E+01

← Auto-detected

**Figure 6-8 Capacitance Manometer Setup Information Displayed on the 946 LCD Screen**

### 4. Factory Default

When YES is selected for Factory Default, the Manual Zero data is removed, and its value is reset to zero (factory default). The default setting is NO.

On the front panel LCD display, a small U under the gauge type indication (i.e CM) will disappear if the gauge was manually calibrated before (user calibrated).

### 5. Auto Zero

This allows the use of either ▲ or ▼ to select a valid gauge for autozeroing i.e. - the Baratron shown in the table below. The available channel is auto-detected. There is an option of NA which can be selected if Auto Zero is not required. The autozero will be executed only when

- (1) System pressure is less than  $10^{-5} \times P_{FS}$  (5 decades lower than the full scale)
- (2) The Baratron reading is between  $5 \times 10^{-4} \times P_{FS}$  and  $0.05 \times P_{FS}$  (0.05% to 5% of the full scale)

When a Capacitance Manometer is zeroed, a U will be displayed under the gauge type indicator (CM) to indicate that this Manometer has been user calibrated.

You cannot use another Capacitance Manometer to autozero a Capacitance Manometer since the range cannot be auto-detected. Table 6-1 shows the valid gauges that can be used for autozeroing Manometers that have different full-scale ranges.

Full scale of CM	CP	PR	CC	HC
$\geq 1000$ Torr	Yes	Yes	Yes	Yes
100 Torr	No	Yes	Yes	Yes
$\leq 20$ Torr	No	No	Yes	Yes

**Table 6-1 Valid Gauges for Autozeroing Capacitance Manometers of Different Ranges**



**The Capacitance Manometer and the reference auto-zero sensor must be connected to the same chamber at all times.**

#### 6. Manual Zero

The default setting for the Manual Zero function is NO. When it is set to YES the Manometer can be manually zeroed. To do so, the system pressure must be less than  $10^{-5} \times P_{FS}$  (5 decades less than the full scale). The Manual Zero function will abort if the overall offset is great than 5% of the full scale.

When a Capacitance Manometer has been manually zeroed, a U will be displayed under the gauge type indicator (CM) to indicate that this Manometer is user calibrated.

#### 7. Operation Voltage

The operation voltage on the 946, is fixed at +/- 15 Volts. This limits the selection of capacitance manometers to only those requiring +/- 15 Volts operation power.

#### 8. Relay

Relays for each Capacitance Manometer channel are preset (2 per channel), as shown below. These values are auto-detected.

Sensor location	A1	A2	B1	B2	C1	C2
Relay assigned	1 & 2	3 & 4	5 & 6	7 & 8	9 & 10	11 & 12

#### 9. Enable

There are three ways to enable a relay:

- a. SET: forces the relay to stay in the activated state (closed) regardless of pressure and set point values
- b. CLEAR: forces the relay to stay in the deactivated state (open) regardless of pressure and set point values.
- c. ENABLE: the relay status is determined by the pressure, set point value, and direction.

## 10. DIR

DIR determines when the relay is activated. If ABOVE is selected, the relay will be activated when the pressure is above the set point (higher than the set point pressure). If BELOW is selected, the relay will be activated when the pressure is below (less than) the set point. The default setting for DIR is BELOW.

Figure 8-1 provides a more detailed description of the DIR setting.

## 11. SET SP

The SET SP function allows input of the set point value. The unit will accept a range of 100% of the manometer full scale range. The speed of the value change can be increased by continuously pressing the ▲ or ▼ key during the setting change.

## 12. Hyst

When a set point value has been changed, the hysteresis value will be changed automatically. If DIR is set to ABOVE, the hysteresis is automatically set to 0.9xSet point; if DIR is set to BELOW, the hysteresis is automatically set to 1.1xSet point.

To modify the hysteresis, move the cursor to the hysteresis value and press **Enter**. Using the ▲ or ▼ key, change the value, then press **Enter** again to set the value. When DIR has been set to ABOVE, the maximum hysteresis value permitted for a Capacitance Manometer is 0.99xSet point; when DIR is set to BELOW, the minimum hysteresis value is 1.01xSet point.

### 6.5.3 Setup for a PR (Pirani)/CP (Convection Pirani) Sensor

Refer the Figure 6-9 for setting up a Pirani or Convection Pirani sensor.

Auto-detected

Setup Convection Pirani Gauge **C2**

Sensor	CP	Gas Type	N2	FD	NO
Auto Zero	NA		Manual Zero		
ATM Value	7.6E+02	ATM Cal		NO	
← Message Box					
Relay	Enable	DIR	SET SP	Hyst	
Relay 11	ENABLE	ABOVE	1.0E-02	9.0E-03	
Relay 12	CLEAR	BELOW	3.0E-01	3.3E-01	



Auto-detected

**Figure 6-9 Pirani/Convention Pirani Setup Information that is Displayed on the 946 LCD Screen**

1. Sensor

The Sensor Type is often auto-detected during the initial power up the Pirani or Convection Pirani sensor. If the sensor type is auto-detected, a user cannot change the sensor type from the front panel. However, when a dummy sensor is connected to the controller, it cannot detect the sensor automatically. Under this condition, the sensor type can be selected manually, and stored in the memory. This information will be used as the default sensor type if sensor power is cycled.

2. Gas Type



Select the gas type by moving the cursor to the Gas Type box and pressing  key. Use the  or the  keys to select the correct gas type for the sensor. Three gas types (N<sub>2</sub>, Ar and He) can be selected. The default setting is N<sub>2</sub>.

3. FD (Factory Default)

If YES is selected for Factory Default, the Manual Zero and ATM Cal data are restored to the factory default values. The default setting for the Factory Default function is NO.

A small U under the gauge type indication on the front panel LCD display (PR or CP) will disappear if the gauge was manually calibrated.

4. Auto Zero

Use the  or the  keys to select a valid gauge for autozeroing the Pirani (PR) or Convection Pirani (CP). An Ion gauge must be used as the zero reference.

The zero will be executed for Pirani only when:

- (1) The system pressure is less than  $1 \times 10^{-6}$  Torr ( $1 \times 10^{-5}$  Torr for Convection Pirani).
- (2) The Pirani reading is within the range  $5 \times 10^{-5}$  Torr ( $5 \times 10^{-4}$  Torr for Convection Pirani) and  $1 \times 10^{-2}$  Torr.

The default setting for the Auto Zero function is NO.



**Ensure that the Pirani/CP and the reference auto-zero Ion Gauge sensor are connected to the same chamber at all times.**

5. Manual Zero

The Pirani/CP sensor can be manually zeroed when YES is selected for this function. Ensure that the system pressure is less than  $1 \times 10^{-6}$  Torr ( $1 \times 10^{-5}$  Torr for CP) before executing a Manual Zero. The Manual Zero function will abort if the overall offset is over  $1 \times 10^{-2}$  Torr. The default setting for the Manual Zero function is NO.

On the front panel LCD display, a small U under the gauge type indication (i.e CP or PR) will appear when the gauge is manually zeroed.

6. ATM Value

This value is used to calibrate the Pirani/CP at atmospheric pressure. The default value is 760 Torr. Recall that elevation and weather will affect local atmospheric pressures.

On the front panel LCD display, a small U under the gauge type indication (i.e CP or PR) will appear when the gauge is manually calibrated.

7. ATM Cal

When YES is selected for the ATM Cal function, the ATM Value will be entered as the reference pressure for the ATM calibration of Pirani/CP. The default setting for the ATM Cal function is NO.

On the front panel LCD display, a small U under the gauge type indication (i.e CP or PR) will appear when the gauge is manually calibrated.

## 8. Relay

Relays for each PR/CP channel are preset (2 per channel) as shown below. These values are auto-detected.

Sensor location	A1	A2	B1	B2	C1	C2
Relay assigned	1 & 2	3 & 4	5 & 6	7 & 8	9 & 10	11 & 12

## 9. Enable

There are three ways to enable a relay:



- SET: forces the relay to stay in the activated state (closed) regardless of pressure and set point values
- CLEAR: forces the relay to stay in the deactivated state (open) regardless of pressure and set point values.
- ENABLE: the relay status is determined by the pressure, set point value, and direction.

## 10. DIR

DIR determines when the relay is activated. If ABOVE is selected, the relay will be activated when the pressure is above the set point (higher than the set point pressure). If BELOW is selected, the relay will be activated when the pressure is below (less than) the set point. The default setting for DIR is BELOW.





Refer to Figure 8-1 for more a detailed description of the direction setting.

## 11. SET SP

This function allows input of the desired set point value. The valid range is  $2 \times 10^{-3}$  to  $9.5 \times 10^{+1}$  Torr for Pirani gauges, and  $2 \times 10^{-3}$  to  $9.5 \times 10^{+2}$  Torr for Convection Pirani gauges. The speed of the value change can be increased by continuously pressing the  or  key during the setting change.

## 12. Hyst

When the set point value has been changed, the hysteresis value will be changed automatically. If DIR is set to ABOVE, the hysteresis will automatically be set to  $0.5 \times \text{Set point}$ ; if DIR is set to BELOW, the hysteresis is automatically set to  $1.5 \times \text{Set point}$ .

To modify the hysteresis, move the cursor to the hysteresis value, press  and use the  or  keys to change the value, then press  again to set the value. The maximum hysteresis value permitted for PR/CP gauges is  $0.9 \times \text{Setpoint}$  when DIR is set to ABOVE; the minimum hysteresis is  $1.1 \times \text{Set point}$  when DIR is set to BELOW.

## 13. Power Control of a Pirani or Convection Pirani Sensor

Power to the Pirani or Convection Pirani gauges can be turned on or off using the Power On/Off push button.

Note that when a pyrophoric gas is encountered (such as during the degeneration of cryo-trap), it is strongly recommended that the filament power of the Pirani or Convection Pirani sensor be turned off to avoid any potential for ignition of the gas.

The power to the Pirani sensor should also be turned off when sensors are “hot swapped” to avoid any potential for sensor damage.



If the power for a Pirani or Convection Pirani is turned off while it is controlling (either AUTO or SAFE) an ion gauge, the Ion gauge will be switched off immediately. To avoid the Ion gauge being turned off at high vacuum (especially, for a Cold Cathode gauge which may take long time to start at UHV), it is recommended to disable the control of the Ion gauge first before powering off a Pirani or Convection Pirani sensor.

When the power to the Pirani is turned on, a time delay is added to avoid having an Ion gauge being turned on at high pressure when a potential inaccurate transient pressure indication may occur while the power-up for PR/CP sensor is in progress.

### 6.5.4 Setup a Cold Cathode Sensor

Please refer the Figure 6-10 for setting a Cold Cathode Sensor.

1. Gas Type (GT)

To move the cursor to the Gas Type box, press , then use the  or  keys to select the correct gas type for the sensor. Three gas types (N<sub>2</sub>, Ar and He) can be selected. Default setting for Gas Type is N<sub>2</sub>.

2. User Input Calibration Gas Correction Factor (U Cal)

This allows the user to enter different correction factors for Cold Cathode sensors. This function is useful, when the calibration gas used is not one of these listed above (N<sub>2</sub>, Ar or He). The valid range is 0.1 to 50, and the default setting is 1.0.

Setup CC Gauge A1					
GT	N2	U Cal	1.0E+00	AO Delay	3
Fast Relay SP		1.0E-05		Prot SP	5.0E-03
Relay	Enable	Dir/Ch	SET SP	Hyst	
Relay 01	SET	BELOW	1.0E-06	9.0E-07	
Relay 02	CLEAR	BELOW	3.0E-05	3.3E-05	
Relay 03	ENABLE	BELOW	2.0E-08	1.8E-09	
Relay 04	CLEAR	BELOW	5.0E-07	5.5E-07	
Control SP	AUTO	B1	1.0E-03	1.2E-03	

Figure 6-10 Cold Cathode Setup Information as Displayed on 946 LCD Screen

3. AO Delay

The Analog Out Delay function prevents the activation of the Cold Cathode sensor's set point relays and maintains their outputs in the OFF state until the delay has expired. The range is from

3 to 300 seconds and the default value is 3 seconds. When the AO delay is active, WAIT will be displayed on the front panel rather than a pressure reading.

#### 4. Fast Relay SP<sup>12</sup>

To meet the requirement for fast control of vacuum system (such as to close a valve rapidly to protect an UHV system), a special Cold Cathode control module with a fast relay control is available. The response time is typically less than 15 msec, and the control set point for this fast relay is set via the Fast Relay SP described here. The hysteresis is approximately 15% of the set point value, that is, the relay will be re-energized when the system pressure is 15% below the set point. The default set point value is  $1 \times 10^{-5}$  Torr.



**The fast response relay is only available on the (CL) type cold cathode card. See 937B/946 cold cathode addendum.**

#### 5. Protect SP

The Protect Set Point function will turn the Cold Cathode high voltage off at the specified pressure readings. The valid Protect Set point range for a Cold Cathode is  $1.0 \times 10^{-5}$  Torr to  $1.0 \times 10^{-2}$  Torr. The default value is  $5.0 \times 10^{-3}$  Torr. It can be disabled if you continue to press  button when the set point value is over  $1.0 \times 10^{-2}$  Torr.



**When the Protect Set Point is triggered, the Auto control is disabled. The gauge can then be turned on only manually or by serial command. This is due to the fact that the gauge control set point should normally act first. When Protect Set Point is tripped, this indicates that the control set point is not function properly, probably due to an inappropriate system configuration (control gauge and ion gauges are not connected to a same volume), or to a control gauge malfunction.**

#### 6. Relay

Relays for each channel are preset as shown below. These values are auto-detected. When single sensor CC board is used, 4 relays are assigned to each Cold Cathode sensor.

Sensor location	A1	B1	C1
Relay assigned	1 & 2 & 3 & 4	5 & 6 & 7 & 8	9 & 10 & 11 & 12

#### 7. Enable

There are three ways to set a relay:

- SET: forces the relay to stay in the activated state (closed) regardless of pressure and set point values
- CLEAR: forces the relay to stay in the deactivated state (open) regardless of pressure and set point values.
- ENABLE: the relay status is determined by the pressure, set point value, and direction.



#### 8. DIR

To prevent the Cold Cathode from being turned on at high pressure, the DIR for a Cold Cathode is set to BELOW permanently.

Refer Figure 8-1 for more detailed description of the direction setting.





<sup>12</sup> FAST relay SP works only when the special Cold Cathode board with fast relay output is included.

## 9. SET SP

This function permits input of a desired set point value. The valid range is  $2 \times 10^{-10}$  to  $5 \times 10^{-3}$  Torr. To speed up the value change, hold the  or  key.

## 10. Hyst

Once a set point value has been changed, the hysteresis value will automatically be changed. Since the direction is set to BELOW for Cold Cathode sensor only, the hysteresis will be set to  $1.5 \times \text{Setpoint}$  automatically.

To modify the hysteresis, move the cursor to the hysteresis value and press . Use the  or  key to change the value, then press  again to set the value. The minimum hysteresis value for a Cold Cathode gauge is  $1.1 \times \text{Set point}$ ; DIR is set to BELOW at all times.

## 11. Control SP

The Control Set Point function is used to turn the Cold Cathode gauge on or off by using a reference gauge, typically a Pirani, Convection Pirani or a Capacitance Manometer ( $\leq 2$  Torr full scale). This function prevents the Cold Cathode Gauge from operating at high pressure, thereby extending the service life of the Cold Cathode sensor. Valid Control Set point values range from  $5 \times 10^{-4}$  to  $1 \times 10^{-2}$  Torr for a Pirani, from  $2 \times 10^{-3}$  to  $1 \times 10^{-2}$  Torr for a Convection Pirani gauge, and from 0.2% of full scale to  $2 \times 10^{-2}$  Torr for Capacitance Manometer ( $\leq 2$ T full scale). The upper limit can be extended to 0.95 Torr using a serial command. The default Control Set Point value is  $5 \times 10^{-3}$  Torr.



**If the controlling gauge (PR/CP/CM) and Cold Cathode gauge are connected to the same chamber, ensure that the control SP is less than  $5 \times 10^{-3}$  Torr; otherwise, the CC sensor life may be shortened due to high operating pressure. The CC sensor may be turned off by the Protect Set Point function.**



**The  $1 \times 10^{-2}$  Torr upper limit can be extended to  $9.5 \times 10^{-1}$  Torr by using a @254XCS!ON;FF serial command to cover the condition when the PR/CP/CM and CC are installed on different location. For example, when the PR/CP/CM is installed on the foreline between the mechanical and turbo pumps (being used to monitor the mechanical pump pressure), and the CC is installed on the high vacuum chamber downstream of the turbo pump.**



**When the power of PR/CP is turned off, or the cable is unplugged, the CC will be turned off if the control set point is enabled.**



**When a Capacitance Manometer ( $\leq 2$ T) is used to control a Cold Cathode gauge, it is strongly recommended to enable the AUTOZERO of Capacitance Manometer as a zero shift of the Manometer may cause damage of the Ion gauge.**

To set the Control SP, first select the control channel (Dir/Ch). Once a valid channel has been selected, the Control SP function can be enabled. There are three choices:

- AUTO: the high voltage for a Cold Cathode gauge is controlled solely and automatically by the controlling gauge (PR/CP). However, if the protection set point is triggered, the auto control will be disabled, and the CC sensor can only be turned on manually.
- SAFE: the high voltage for a Cold Cathode Gauge can be automatically turned off by the controlling gauge; however, it can only be turned on manually. This keeps the



Cold Cathode sensor from being turned on at high pressure, especially, when the controlling gauge is not properly set.

- OFF: Even if the control channel is selected, it will not be activated. The Cold Cathode must be turned on/off manually.



## 12. Cold Cathode Board with Fast Relay Output

When fast control using a Cold Cathode sensor is required (<15 msec), a Cold Cathode board with fast relay output control is available. This fast control is achieved by comparing the buffered analog output signal with an internal DAC output determined by a serial command (@254FRCn!d.dE-ee;FF, where *n* is the channel number (1, 3, 5), and *d.dE-ee* is the pressure set point value). The comparator controls an opto-isolated solid state relay, which enables the fast control of an external device.

### 6.5.5 Setup a Hot Cathode Sensor

Refer to Figure 6-11 for setting up a Hot Cathode sensor.

#### 1. Gas Type

Move the cursor to the Gas Type box, press , and use either  or  key to select the correct gas type for the sensor. Four gas types (N2, Ar, He and CUST) can be selected.

When N2, Ar, and He are selected, the corresponding gas correction factor is displayed on the right-hand side of the Gas Type box, and this value cannot be modified. However, when CUST is selected, a customized gas factor can be entered, and the valid range is from 0.1 to 50. Values shown in Table 6-2 may be used if the type of gas inside the vacuum chamber is known. More detailed correction factors are available in Appendix 14.1.

#### 2. Filament

Indicates the number of the filament being used. The valid values are 1 and 2. The default setting is 1.

Gas Type	N2	1.0	Filament	1
DG Time	30	Sensitivity		9.0
EC	20 uA	Protect Setpoint		5.0E-03
Relay	Enable	Dir/Ch	SET SP	Hyst
Relay 01	SET	BELOW	1.0E-06	9.0E-07
Relay 02	CLEAR	BELOW	3.0E-05	3.3E-05
Relay 03	ENABLE	BELOW	2.0E-08	1.8E-09
Relay 04	CLEAR	BELOW	5.0E-07	5.5E-07
Control SP	SAFE	B1	1.0E-03	1.2E-03

Figure 6-11 Hot Cathode Setup Information Displayed on 946 LCD Screen

Gas	Symbol	Relative correction factor to N <sub>2</sub>
Air		1.00
Argon	Ar	1.29
Carbon Dioxide	CO <sub>2</sub>	1.42
Deuterium	D <sub>2</sub>	0.35
Helium	He	0.18
Hydrogen	H <sub>2</sub>	0.46
Krypton	Kr	1.94
Neon	Ne	0.30
Nitrogen	N <sub>2</sub>	1.00
Nitrogen Oxide	NO	1.16
Oxygen	O <sub>2</sub>	1.01
Sulfur Hexafluoride	SF <sub>6</sub>	2.50
Water	H <sub>2</sub> O	1.12
Xenon	Xe	2.87

**Table 6-2 Relative Ionization Correction Factor to N<sub>2</sub> for Different Gases**

3. DG Time

Refers to the degas time set for a Hot Cathode gauge. The value can be set from 5 to 240 minutes with a minimum step of 1 minute. The default value is 30 min.

4. Sensitivity

Indicates sensitivity of the Hot Cathode gauge. Its typical value is 9 Torr<sup>-1</sup> for the MKS Low Power Nude sensor, and 12 Torr<sup>-1</sup> for the Mini BA gauges. These default values will be automatically selected based on the type of sensor being detected if no user-defined sensitivity value is stored.

A user can change the sensitivity, and its valid range is 1 to 50 Torr<sup>-1</sup>. Once a user-defined sensitivity is saved, this sensitivity value will be used as default value when powering up a same type of Hot Cathode gauge.

If a user changes the sensitivity without a Hot Cathode gauge being connected, this user-defined sensitivity value will be saved as the default sensitivity for all the HC sensor types.

5. EC

The Emission Current can be set to 20 uA, 100 uA, Auto20, or Auto100. When Auto is selected, the emission current is either 20 uA or 100 uA when pressure is higher than 1x10<sup>-4</sup> Torr, and automatically switches to 1 mA when pressure is below 1x10<sup>-4</sup> Torr. The default setting for the Emission Current is 20 uA.

6. Protect SP

The Protect Set Point is used to turn off the Hot Cathode high voltage based on its own pressure readings. The valid protect set point range for a Hot Cathode is  $1.0 \times 10^{-5}$  Torr to  $1.0 \times 10^{-2}$  Torr. The default value is  $5.0 \times 10^{-3}$  Torr. It is can be disabled if the you continue to press  button when the set point value is over  $1.0 \times 10^{-2}$  Torr.



**Once the Protect Set Point is triggered, the Auto Control will be disabled. The gauge can be turned on only manually (or by serial command) because the control set point should normally act first. The tripping of the Protect Set Point indicates that the control set point is not functioning properly, most likely caused by an inappropriate system configuration (control gauge and Ion gauges are not connected to the same volume), or a control gauge malfunction.**

## 7. Relay

Relays for each channel are preset (4 per channel) as shown below, and auto-detected.

Sensor location	A1	B1	C1
Relay assigned	1 & 2 & 3 & 4	5 & 6 & 7 & 8	9 & 10 & 11 & 12

## 8. Enable

There are three ways to enable a relay:



- SET: force the relay to activate (close) regardless of pressure and set point values
- CLEAR: force the relay to deactivate (open) regardless of pressure and set point values.
- ENABLE: relay status is determined by the pressure, set point value, and direction.

## 9. DIR

To prevent the hot cathode from being turned on at high pressure, the DIR for a **Hot Cathode** is permanently set to BELOW.





Refer to Figure 8-1 for a more detailed description of the direction setting.

## 10. SET SP

Enables setting of the desired set point value. The valid range is  $5 \times 10^{-10}$  to  $5 \times 10^{-3}$ . To speed up the value change, hold the  or  key.

## 11. Hyst

Once the set point value is changed, the hysteresis value will be changed automatically. Since the direction is set to BELOW for the Hot Cathode sensor only, the hysteresis will be set to  $1.5 \times \text{Set point}$  automatically.

To modify the hysteresis, move the cursor to the hysteresis value, press , use the  or  key to change the value, and press  to set the value. The minimum allowed hysteresis for the Hot Cathode is  $1.1 \times \text{Set point}$  when direction is set to BELOW.

## 12. Control SP

The Control set point is used to turn on or off the Hot Cathode gauge using a reference gauge, typically a Pirani or a Convention Pirani. This prevents the Hot Cathode gauge from operating at

high pressure, and therefore extends the service life of the Hot Cathode sensor. The valid control set point value is from  $5 \times 10^{-4}$  to  $1 \times 10^{-2}$  Torr for a Pirani, from  $2 \times 10^{-3}$  to  $1 \times 10^{-2}$  Torr for a Convection Pirani, or from 0.2% of full scale to  $2 \times 10^{-2}$  Torr for a Capacitance Manometer ( $\leq 2T$  full scale). This upper limit can be extended to 0.95 Torr by using a serial command. The default control set point value is  $5 \times 10^{-3}$  Torr.



**If the controlling gauge (PR/CP/CM) and Hot Cathode gauge are connected to the same chamber, make sure the control SP is less than  $5 \times 10^{-3}$  Torr, otherwise the HC sensor may be damaged due to high operating pressure. The HC sensor can be turned off by the protect set point setting.**



**The  $1 \times 10^{-2}$  Torr upper limit can be extended to  $9.5 \times 10^{-1}$  Torr by using a @254XCS!ON;FF serial command to cover the condition when the PR/CP and CC are installed on different location. For example, when the PR/CP is installed on the foreline between the mechanical and turbo pumps (being used to monitor the mechanical pump pressure), and the CC is installed on the high vacuum chamber downstream of the turbo pump.**



**When a Capacitance Manometer ( $\leq 2T$ ) is used to control a Hot Cathode gauge, it is strongly recommended to enable the AUTOZERO of Capacitance Manometer as a zero shift of the manometer may cause damage of the ion gauge.**

To set the Control SP, first select the control channel (Dir/Ch). Once a valid channel is selected, enable the Control SP. Three choices are available:

- **AUTO:** The filament power for a Hot Cathode gauge is controlled solely and automatically by the controlling gauge (PR/CP).
- **SAFE:** The filament power for a Hot Cathode gauge can be turned off by the controlling gauge automatically, however, it can only be turned on manually. This prevents the Hot Cathode sensor from being turned on at high pressure, especially when the controlling gauge is not set properly.
- **OFF:** Even if the control channel is selected, it is not activated. The Hot Cathode sensor must be turned on/off manually.

## 6.6 Power Control of a Pressure Sensor

When a pressure sensor is attached on a 946 Controller, the power to the pressure sensor may have to be controlled. For example, turning on a HC sensor at ambient pressure may result in a filament burnout, and lead to permanent damage of the sensor.

If flammable gas is used (such as during a regeneration of a  $LN_2$  cooled cold trap), the PR/CP sensor must be turned off to avoid potential explosion.

Only the Pirani (PR), the Convectional Pirani (CP), the Cold cathode (CC) and the Hot Cathode (HC) sensors require power control.

### 6.6.1 Power (including degas) Control of a Sensor using Front Panel Control Button

To turn on/off the power for a sensor (PR/CP/CC/HC) using the front panel button, use the following procedure:

1. Use the ▲ or the ▼ key to select the desired sensor (PR/CP/CC/HC) to be turned on/off. The active channel (sensor) is indicated by the illuminated green LED on the front panel.
2. For an Ion gauge (CC/HC), make sure the gauge is not controlled automatically by another gauge (PR/CP). If it is in the AUTO control mode, disable the control set point before using the front panel keypad to operate the Ion gauge.
3. The  key switches the corresponding sensor on and off.

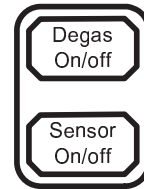

**When the ion gauge is turned on, the filament power may turn off automatically if the pressure is higher than the protection set point. (Default is  $5 \times 10^{-3}$  Torr, and maximum is  $1 \times 10^{-2}$  Torr.)**

A Cold Cathode sensor turns on/off the high voltage to the sensor anode. When Cold Cathode sensors are turned on at very low pressures, the sensor may take a long time to start as the discharge current does not build up immediately.

Prolonged operation at higher pressures will degrade the performance of a Cold Cathode sensor, due to contamination of the sensor caused by rapid sputtering inside the cell at high pressure, which reduces the operating service time before the sensor requires cleaning. Operation at pressures above  $5 \times 10^{-1}$  Torr will result in the sensor falsely indicating a much lower pressure, even though this is very unlikely as the maximum protect set point is set to  $1 \times 10^{-2}$  Torr. This phenomenon is called rollback, and is due to high concentrations of charge particles that make gas conductive at high pressure. Avoid operating conditions that could cause rollbacks.

For the Hot Cathode sensor, operation at high pressure may lead to filament burnout. This is why the Protection Set Point is always enabled for ion gauges within 946 so the gauges can automatically turn off once pressure is higher than the protection set point.

To turn on/off the degas power for a Hot Cathode gauge; the procedure is almost identical to the sensor power control, except that the  button is used.



**When MKS low power nude or Mini BA gauges are used, these sensors (up to 3) can be degassed simultaneously. However, if glass BA is used, only one glass BA sensor can be degassed at a time because of its extremely high degas power consumption (close to 50 W at grid).**

## 6.6.2 Power (including degas) Control of a Sensor via 37 pin AIO D-Sub Connector

A connected pressure sensor can also be turned on/off by sending a control signal to pin 15 to 20 on the 37pin D-sub connector located on the back of the AIO module as shown in Table 6-3.

To turn off a sensor, pull the pin to the ground. The sensor power is turned off when a microprocessor detects a falling edge on the input pin. Cycling gauge channel power, controller power or removing ground from the pin turns the gauge power back on--sensor power is turned on when a rising edge is detected.



The power to an Ion Gauge can be controlled use these methods. Rear panel serial command and front panel power (sensor ON/Off). Any of the three methods can be over ridden by the other.

Since only one Hot Cathode gauge can be connected to the board, pin 16, 18, 20 are used to control the filament degas power.

	Description	Pin	Description
1	Buffered Aout A1	11	Log/Lin Aout C1
2	Buffered Aout A2	12	Log/Lin Aout C2
3	Buffered Aout B1	13	Combination Aout 1
4	Buffered Aout B2	14	Combination Aout 2
5	Buffered Aout C1	15	Power A1
6	Buffered Aout C2	16	Power A2/Degas A1
7	Log/Lin Aout A1	17	Power B1
8	Log/Lin Aout A2	18	Power B2/Degas B1
9	Log/Lin Aout B1	19	Power C1
10	Log/Lin Aout B2	20	Power C2/Degas C1
		21 to 37	Ground

**Table 6-3 Pin Out for Ion Gauge Remote Control**



Control pins 15-20 are pulled up by internal circuit, therefore, there is no external voltage source required to pull up the pin.

### 6.6.3 Power (including degas) Control of a Sensor using Serial Communication Commands

The following serial communication command turns on/off the channel power for a sensor (PR/CP/CC/HC) connected to 946 remotely.

**@254CPn!ON;FF**

Here, n=1 to 6, which is corresponding to the gauge connected to channels A1, A2, B1, B1, C1 and C2, respectively.

The corresponding response that the command has been sent successfully is

**@002ACKON;FF**

To turn off an ion gauge, enter the following command:

**@254CPn!OFF;FF**

The expected response is as follows:

**@002ACKOFF;FF**

The following serial command turns on/off the degas power for a Hot Cathode gauge connected to 946 remotely.

**@254DGn!ON;FF**

Here,  $n=1,3,5$ , which is corresponding to the gauge connected to channels A1, B1, and C1, respectively.

If the command is properly sent, the corresponding response will be:

**@002ACKON;FF**

Use the following command to turn off the degas power:

**@254DGn!OFF;FF**

The expected response is as follows:

**@002ACKOFF;FF**

## 6.7 Channel Setup for Flow Measurement and MFC Based Pressure Control

When an MFC board is installed in a 946 Controller, the 946 Controller can be used to operate MKS Mass Flow Controllers to control the mass flow rate, or operate a mass flow meter to monitor the mass flow rate. Up to six MFCs can be simultaneously controlled by one 946. When both MFC and pressure (CM, PR, CC, HC) boards are installed in the controller, Mass Flow Controller can even be used to dynamically control the system pressure.



Figure 6-12 946 Front Panel.









### 6.7.1 Simple Operations of a Mass Flow Controller

Following simple operation commands for an MFC can be easily executed by pressing the buttons on the 946 front panel: Open, Close, and Set point as shown in Figure 6-12 .

- Open an MFC: To set an MFC to fully open mode (set the internal control valve to fully open condition), following steps are required:
  - Move the green LED on the front panel to a desired MFC channel by pressing either the or the key;
  - Press the key, and an “Open” indicator will start to blinking on the front panel;
  - Press key to confirm the operation, and the “Open” indicator will stop blinking.



**When an MFC is set to Open mode, the flow rate is often significantly higher than the full scale flow rate of the Mass Flow Controller, therefore, it is too high to be measured by MFC (indicated such as >1100 on the front panel for a 1000 sccm MFC).**

- Close an MFC: To set an MFC to fully close mode, following steps are required:
  - Move the green LED on the front panel to a desired MFC channel by pressing either the  or the  key;
  - Press the  key, and a “Close” indicator will start to blinking on the front panel;
  - Press  key to confirm the operation, and the “Close” indicator will stop blinking.
- Set an MFC to set point mode: To set an MFC to set point open mode, following steps are required:
  - Move the green LED on the front panel to a desired MFC channel by pressing either the  or the  key;
  - Press the  key, and a “SP” indicator will start to blinking on the front panel; the “SP” and flow set point value will be displayed alternatively.
  - Press  key to confirm the operation.



The flow set point should be set via the MFC Channel Setup screen as described in section 6.7.2. Due to the limited space, only 2 digit resolution is displayed (for example, a set point of 1350 sccm will be displayed as 1.4E+3).

## 6.7.2 Setup MFC Controlling Parameters for Flow Control

When an MFC is connected to 946 controller, several parameters must be set properly (such as gas scale factor, range) in order to ensure the proper operation of the Mass Flow Controller.

The Mass Flow Controller setup screen can be accessed by moving the green LED indicator to the desired MFC channel first, then press the  button on the 946 front panel as shown in Figure 6-12. The setup screen for an MFC is shown as below:

Setup MFC (sccm) C1							
Scale Factor		1.40		Nominal Range		1.0E+3	
Zero	NO	FD	NO	Range	1.40E+3		
OP Mode		Setpoint		FlowRate SP		2.00E+2	
Operation Voltage:			+15 to 24v				
Relay	Enable	Dir/Ch	SET SP	Hyst			
Relay 01	ON	ABOVE	3.00E+1	2.70E+1			
Relay 02	OFF	BELOW	8.00E+2	8.80E+2			

Figure 6-13 MFC Setup Information Displayed on 946 LCD Screen





Refer to Figure 6-13 for setting up a Mass Flow Controller:

### 1. Scale Factor





Scale Factor is the gas correction factor ratio between the operating gas and the factory calibration gas. If the factory calibration gas is nitrogen, the Scale Factor is identical to



the gas correction factor. Typical gas correction factor values are listed in the Appendix 0 in this manual.

Move the cursor to the Scale Factor box, press  key to highlight the parameter (dark gray background), use the  and  keys to select desired value, and press  key one more time to save the value. The valid range is 0.1 to 10, with a default setting of 1.00.

## 2. Nominal Range

Nominal Range is the flow range in sccm specified on the MFC based on its factory calibration gas. To set the Nominal Range, move the cursor to the Nominal Range box, press  key to highlight the text, use the  and  keys to select the full scale flow rate for the MFC, and press  key one more time to save the value. Note that the MFCs always employ unit of SCCM on 946 setup screen and the valid range is 1.0 to 1.00E+6 sccm (1000 SLM), therefore, when SLM is used for high flow rate MFCs, a factor of 1000 must be multiplied to convert SLM to SCCM.



**The flow rate range unit is sccm only on the MFC setup screen.**

## 3. Zero

When YES is selected for the Zero function, the output of the controller will be set to zero. The default for this function is NO.

To Zero the MFC, please ensure the gas flow of the MFC is zero. This can be done by equalizing the pressure across the MFC.

Once zero MFC flow rate is confirmed, set the Zero parameter to Yes. When Yes is selected, "Ensure zero flow rate across the MFC!" will be displayed;

Press the Enter button to execute the MFC zero process. When the Enter button is pressed, the Offset DAC is automatically adjusted to make the display zero for the selected MFC.

Once MFC zero is executed, an U will be displayed on the front panel such as Channel A1 shown in Figure 6-1 to indicate this channel has been user zeroed.



**The maximum zero offset adjustment for 946 is around 3% full scale of a MFC.**



**946 Display can be zeroed independently by shorting pin 2 and 12 of 15 pin HD D-sub connector on the back of MFC board.**

## 4. FD (Factory Default)

If YES is for selected for the Factory Default function, the Manual Zero is restored to its factory calibration value. Default setting for FD is NO.

After FD command is executed, the user zeroed indication U on the front panel will disappear.

## 5. Range

This is the real gas flow range after the Scale Factor being considered. This value is automatically updated once a new Scale factor or Nominal Range is entered.

## 6. OP Mode

There are five control operation modes available for an MFC once it is connected to 946 Controller. Following three operation modes can be executed on the Setup MFC screen once they are selected and  button is pressed.

- Open: set the valve inside an MFC to operate at fully open condition quickly. Under this operation mode, the flow rate can be significantly higher than the full range of the MFC. This can be useful for system purge application as maximum flow rate is desired.
- Close: set an MFC to operate at fully close condition quickly.
- Set point: MFC operates at a flow rate specified by the flow set point.

These commands can also be executed by using the buttons on 946 Front Panel as described in 6.7.1.

The remaining two operation modes stated below are activated elsewhere (using the PID control dialog box after  button being pressed). However, these operation modes will be displayed here showing the current MFC operation status.

- Ratio: This indicates that multiple MFCs are operated in either Manual Ratio Control Mode or Auto Ratio Control Modes. Both PID control and ratio recipes must be defined first before performing Manual/Auto Ratio control of MFCs.
- PID Ctrl: This indicates that current (single) MFC is operated under the PID Pressure Control Mode, that is, 946 Controller will adjust the flow rate of the current MFC to control the system pressure. PID Ctrl can be switched back to OPEN, CLOSE, or SET POINT mode easily using front panel buttons. If the PID control is turned off at PID Ctrl dialog box, the MFC will be set to SET POINT mode automatically, and the set point value is the Preset value defined in the PID control recipe.

## 7. Flow Rate SP

When an MFC is operated in the set point Mode, Flow Rate SP indicates the flow rate set point for that MFC. The MFC can be set to close when the set point value is less than 2% of the full scale and to open when the set point value is greater than the full scale (100%). When the MFC is set to run in other control modes (Open, Close, Ratio, PID), this set point value is ignored.



**The value for the Flow Rate SP is the actual flow rate, that is, the flow rate after accounting the scale factor.**

## 8. Operation Voltage

The 946 has the ability to power both +/-15Volt MFCs and +15 to +24Volt MFCs. When selecting the operating voltage, verify the operating voltage of the MFC. Note, voltage selection applies to both channels, i.e. B1 and B2.

## 9. Relay

There are two relays assigned for each MFC. These relays are normally used to provide alarm signals. For example, a relay can be used to report a low flow possibly caused by an empty gas cylinder.

### 6.7.3 Set MFC(s) for Dynamically Controlling System Pressure

MFC(s) can be used for the dynamic (PID) control of system pressure. This can be very powerful for many applications such as process control, calibration, controlled chamber backfilling, and etc., where a stable chamber pressure is often desired. The system pressure may be controlled by single MFC (PID Ctrl) or multiple MFCs (Ratio Control).

Since several control parameters are involved in dynamic pressure control using MFC(s), control recipes might be defined first before activate the control. When single MFC is involved in the pressure control, only PID recipe needs to be defined. However, when multiple MFCs are used for ratio system pressure control, an additional ratio recipe must be defined as well as the PID recipe before performing appropriate system pressure control.

For a 946 Controller, only one PID control is allowed to run at a time. However, please note that PID and Set point control can work independently within the same 946 Controller. If one MFC is set to PID control mode, the rest of MFCs can still operate under the Set point mode. Similarly, if several MFCs are operated under the ratio control mode, the remaining connected MFCs can still operate in Set point mode. This feature is useful in process control; for example, certain processes require fixed flow rates for reactive precursors, while the carrier gas flow rate must to be adjusted to meet a desired pressure set point.

#### 6.7.3.1 Set Single MFC for Controlling System Pressure

When an MFC is used to control system pressure, its flow set point value often varies dynamically as it is affected by system pumping capability, gas flow rate, system pressure, chamber size, and many other factors. This demands a PID control method for controlling the flow rate dynamically in order to maintain the system pressure at a desired value.

An appropriate PID recipe must be selected and defined in 946 Controller when to operate an MFC under PID control mode. The PID Recipe is a collection of 14 control parameters and settings associated with a PID control of system pressure. In a 946 Controller, maximum of 8 recipes (R1 to R8) can be defined as shown in Figure 6-14.

Pressure Control Parameter Setting Recipe							
R1	R2	R3	R4	R5	R6	R7	R8
B1	B2	C1	C2	Rat	VLV	NA	NA
PID Ch	C1	P Ctrl Ch		A1	P Sp	5.0E+2	
Prop - Kp		1.0E+1		CtrlStart		10s	
Integral - Ti		1.0E+1		Start		0.0%	
Derivative - Td		1.5E+0		End		30.0%	
Base		0.0%		Ceiling		90.0%	
Direction		Upstream		Preset		30%	
GainSchedBand		0%		SchedGainCoeff		1	





Figure 6-14 Single MFC Control Recipe Setup Screen



The Base, Ceiling, Preset, Start and End are the percentage of the full scale flow rate of the MFC on the assigned PID channel, not the actual flow rate.

### 6.7.3.1.1 Set the Recipe for Single MFC PID Control

To edit and set a PID recipe, following steps are required to enter the editing mode for PID recipe:

1. Press the  button, move the cursor to PID Recipe Edit as shown in Figure 6-4, then press  key to display the Pressure Control Parameters Setting Recipes screen as shown in Figure 6-14;
2. Press  or  keys to select a desired recipe for editing or displaying (highlighted by grey background, such as C1 in Figure 6-14), then, press  to enter key to enter the edit mode. Once the 946 Controller is at the PID recipe editing mode, one can edit any of the 14 PID parameters and settings associated with each recipe.



**For all 14 parameters used in MFC PID/Ratio control, only 4 parameters (P set point, Prop-K<sub>p</sub>, Integral-T<sub>i</sub>, and Derivative-T<sub>d</sub>) associated with the active recipe (the recipe being used by the PID control) can be modified while the PID control is actively running. For rest of parameters associated with the active recipe, the PID control must be stopped in order to change them. However, for non-active recipes, all these 14 parameters can be changed (either from front panel or serial communication).**

Refer to Figure 6-14 for setting up MFC PID control recipe:

- PID Ch: This describes the channel of the controlling MFC (single MFC control) or method (for Ratio) of controlling the system pressure.
  - a) When single MFC is used for pressure control, the name of the channel where the MFC is connected (valid names are: A1, A2, B1, B2, C1 and C2) is used. Since at least one pressure control board (e.g., a Capacitance Manometer board) is required for measuring and controlling the pressure, only valid selections will be displayed (maximum of 4 channels) for selection.
  - b) When multiple MFCs are used for Ratio pressure control, the valid name will be Rat.
  - c) When a valve is used for pressure control, the valid name is Vlv.
  - d) If nothing is defined for the recipe, NA is used.
- P Ctrl Ch: This assigns the gauge channel for pressure control. The default value is NA, and available options are automatically detected.
- P Sp: This is the pressure set point for the system control. Note that the pressure unit is same as the unit set for the 946 Controller.
- Proportional ( $K_p$ ): This is the proportional control parameter for the PID control of the system pressure. During the pressure control process, the 946 calculates the deviation between the current pressure reading and the set point, and multiplied by the Proportional gain setting. The 946 sets the corresponding MFC/valve control signal proportional to the Proportional gain setting and the error signal.

The generic expression of PID control used in a 946 Controller is described as follow:

$$Q(t) = K_p \left[ e(t) + \frac{1}{T_i} \int_0^t e(\tau) d\tau + T_d \frac{de(t)}{dt} \right]$$

Where,  $Q(t)$  is the control variable (flow rate for MFC, and valve position for valve), and  $e$  is the control error: ( $e = p_{sp} - p$ ) for upstream control, and ( $e = p - p_{sp}$ ) for downstream control.



**Note that a higher proportional gain results in a larger change in the control signal for a given change in the error. If the proportional value is too high, the system can become unstable. In contrast, a small proportional results in less responsive (sensitive) control. The range for Proportional gain is 0.002 to 10000. The default setting is 10.0.**



**Since the control error is actual pressure. In order to avoid the Proportional  $K_p$  being pressure unit dependent, Torr is used for all internal pressure calculations and control.**

- Integral ( $T_i$ ): This is the integral control parameter (time constant) for PID control of system pressure. The integral term of the control can eliminate the proportional offset error that can be accumulated over the time. The integral function considers accumulated offset over time, and adjusts the control output of the controller by adding an offset term obtained by multiplying the Integral gain and the accumulated error.



**Note that if the integral time constant is too short ( $T_i$  value is too small), the accumulated error may become too large, it can cause the controlled variable to overshoot the set point (cross over the set point, creating a large positive deviation). The valid range for Integral gain is 0.01 to 10000 second. The default setting is 1 sec for 946 Controller.**

- Derivative ( $T_d$ ): This is the derivative control parameter (time constant) for PID control of system pressure. The derivative function creates a valve control signal based on the rate of change in the sensor's pressure reading (i.e. the first order derivative of the pressure reading with respect to time).



**The derivative term functions to slow the rate of change in the pressure. It reduces the magnitude of the overshoot produced by the integral component, and improves the combined control stability. However, differentiation of a signal amplifies noise and this can cause instability in the process control if the noise and the derivative gain are sufficiently large. The range for Derivative gain is 0 to 1000 second and the default value is 0.2 seconds. For MFC,  $T_d$  should be set to zero due to its slow response of the flow rate to the corresponding pressure change.**

- Ceiling: Ceiling is a control parameter that sets the upper limit of the control signal output. This is expressed as the percent of full scale for a MFC or the percentage of the valve opening for a valve. For example, a ceiling setting of 80% for a MFC with 1000 sccm full scale means the flow rate should not go above 800 sccm, while a ceiling setting of 80% for a valve means the valve control signal output should not go above 80% of its opening.

The valid range is from Base+10% to 100%. The default setting is 100% and it must be 10% larger than the Base parameter value.

Appropriate setting of ceiling can avoid the overshoot of the pressure control, therefore, often leads to more stable control (as flow rate could be significantly higher than the full scale when the valve is set to open).

- Preset: The Preset value is used to set the flow rate for an MFC (as a percent of the MFC full scale) or the position (as the percent of valve opening) of the valve when the PID control is terminated.

The valid range for Preset is from 0 to 100%. The default value is CLOSE for a MFC, or 0% for a valve. Once a PID control is terminated, the control mode switches to Set point control mode automatically, and the set point value is changed to Preset value.

- **Base:** Base is a control parameter that sets the lower limit of the control signal output. This is expressed as the percent of full scale for a MFC or the percentage of the valve opening for a valve. For example, a Base setting of 20% for an MFC with 1000 sccm full scale means the flow rate should not go below 200 sccm, while a Base setting of 20 for a valve means the valve control signal output should not go below 20% of its opening.

The valid range is from 0 to 100%. The default setting is 0 and it must be either equal to less than the Start parameter value.

A non-zero setting for Base will override the Softstart process, and Base setting will override the Start setting if it is higher than and Start setting.

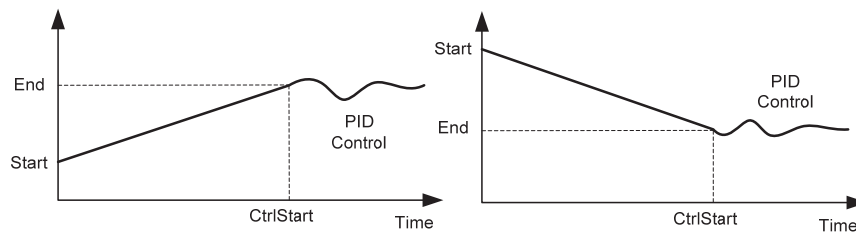

**Figure 6-15 Controlled Start Process**

- **Start:** The Start value is the initial set point value for MFC (or the initial position for valve) during the slow start control process.
  - a) If Base setting is greater than the Start value, the Start will be overridden by Base.
  - b) If Ceiling setting is less than the Start value, the Start will be overridden by Ceiling.

The range is from 0 to 100% of full scale for a MFC, or from 0 to 100 % for a control valve. The default setting is 0, and it must be equal or larger than Base parameter value.

- **End:** The End value is the ending set point value for MFC (or the ending position for valve) during the slow start control process (ramp before PID control)
  - a) If Base setting is greater the End value, the End will be overridden by Base.
  - b) If Ceiling setting is less than the End value, the End will be overridden by Ceiling.

The range is from 0 to 100% of full scale for a MFC, or from 0 to 100 % for a control valve. The default setting is 0, and it must be equal or larger than Base parameter value.

- **CtrlStart:** The CtrlStart value is the time period (in second) over which the valve drive signal (thus, the valve position) or the MFC flow drive signal goes from the Start to the End value defined as defined above.

The slow start process as shown in Figure 6- allows a controlled ramping (up or down) process before dynamic PID control starts, which provides flexibility for the control. If the Start value is set to zero, this becomes a soft start process that can be used to

prevent turbulence, reducing the particles in the process chamber during the initial pump down process

This process will not be executed if the SlowStart is set to zero.

- **Direction:** Direction sets the valve control to either Upstream or Downstream. During Upstream control, higher set point often leads to higher chamber pressure, while it is just opposite during Downstream pressure control process. When a Throttle Valve is used, the Direction must be set to Downstream. When MFC is used, it is automatically set to Upstream.
- **GainSchedBand:** This is the band for gain scheduling PID control, that is, allows different proportional gain  $K_p$  at different error band during pressure control. This is often used for maintaining stable control around the set point (within the scheduled PID control zone as shown in Figure 6-16, while ensuring the fast approach to the set point in the normal PID control zone where the control error is large (such as at the beginning of the control process)).

The GainSchedBand is defined as  $|e|/p_{sp} = |p_{sp} - p|/p_{sp}$ , the valid range for GainSchedBand is from 0 to 30%, and default setting is 0.

- **GainSchedCoeff**

The SchedGainCoeff is the Gain reduction coefficient for PID scheduled control. By reducing the proportional gain  $K_p$  in the scheduled PID control zone, it allows more stable control near the set point, avoid potential large overshoot during the control, eventually, provide the optimal balancing between the requirements of fast initial control and stable set point control. The valid range is from 1 to 200, and the default value is 1 (no scheduled PID).

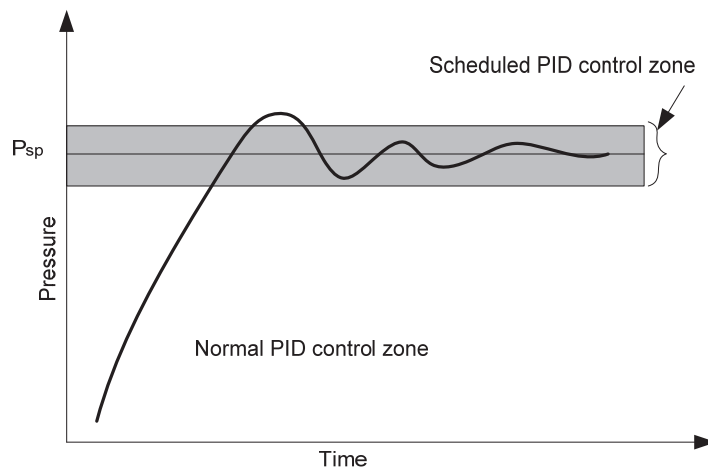
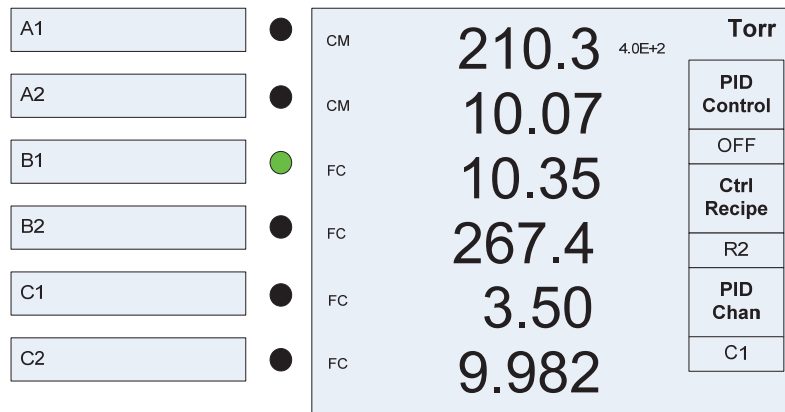

**Figure 6-16 Schematic of a Scheduled PID Control**

#### **6.7.3.1.2 Activate PID Pressure Control using Single MFC**

Once a PID control recipe is properly defined, a PID control can be activated for controlling the system pressure. The steps for activating a PID control using single channel MFC are shown below:

- Press  button (you may need to press this key a couple of times) until the front panel displays the PID Control dialog box for single channel MFC PID control as shown in Figure 6-17.
- Select the appropriate control recipe for the PID control. Once a PID recipe is selected, the corresponding PID Ch (such as C1 shown in Figure 6-17) will be displayed. This is the channel where the MFC being connected for controlling the system pressure. That is, the flow rate of the MFC will be varied automatically in order to control the system pressure. At the same time, the pressure set point value is displayed on the front panel as well (in align with the corresponding channel where the pressure gauge is connected, such as 4.0E+2 for A1 as shown in Figure 6-17) to assist the identification of the pressure gauge being used for control, and the comparison between the real pressure reading and corresponding set point value.



**Figure 6-17 Front Panel Display with the Dialog Box for Single MFC PID Control.**

- Change the PID Control parameter from OFF to ON to start the PID control process. Once PID control is started, the PID control dialog box disappears automatically.

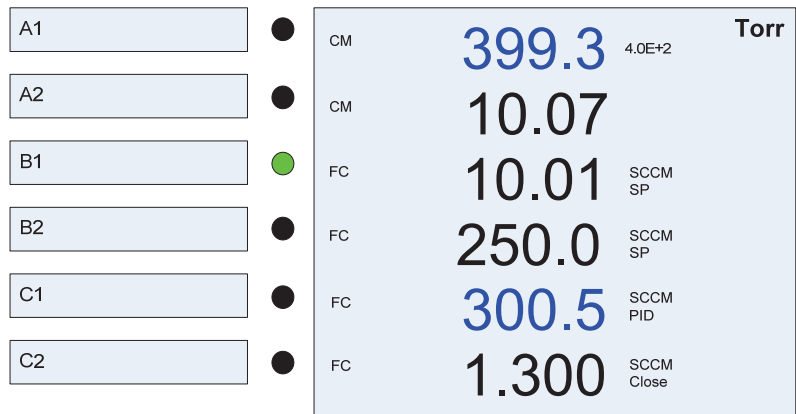







**Figure 6-18 Front Panel Display during PID Control using Single MFC**

- During PID control process, the active MFC flow reading and corresponding controlling pressure gauge reading are displayed in blue color to assist in distinguishing between these channels. In addition, PID will be displayed as well to indicate that channel C1 is under the PID control as shown in Figure 6-18.
- The color of the flow rate will turn into red if the real flow rate is >2% of full scale and 20% off the PID set point value. This may happen, for example, when the gas supply valve for the MFC is turned off accidentally during the PID control process. Therefore, it will provide a warning for user to pay attention to the control.



### 6.7.3.1.3 Terminate Single MFC PID Control

To terminate a single MFC based pressure control, you can choose any one of the following approaches depending upon your termination condition:

1. Close the MFC:  
If you want to close the MFC completely, you can move the green LED indicator to the PID Channel (active MFC channel), and press the  button on the front panel, and  key to confirm the action.
2. Open the MFC:  
If you want to Open the MFC completely, you can move the green LED indicator to the PID Channel (active MFC channel), and press the  button on the front panel, and  key to confirm the action.
3. Set the MFC to fixed set point defined by the Flowrate SP in Channel setup screen:  
If you want to switch the flow rate to that is defined in channel setup screen, you can move the green LED indicator to the PID Channel (active MFC channel), and press the  button on the front panel, and  key to confirm the action.
4. Set the MFC to the set point defined in the recipe (Preset)
  - Press the  to display the PID Control dialog box
  - Switch the PID Control parameter from ON to OFF as shown in Figure 6-17. Once the PID control is turned off, the flow rate for the MFC will be changed to the Preset set point as defined in the recipe as shown in Figure 6-14.

### 6.7.3.1.4 Effect of PID Recipe Change While Control is Running

Some of the parameters associated with the active PID control can be changed (via either from panel or serial communication) while the PID control is running. They are pressure set point (P Set point), proportional (Prop-Kp), integral (Integral-Ti), and derivative (Derivative-Td). This allows adjusting and optimizing these parameters without turning on/off the PID control. However, for rest of PID recipe parameters, they are not allowed to change while the control is running. Certainly, for rest of non-active recipes, there is no such a restrictions, that is, their parameters can be modified at any time.

When any of these 4 parameters in PID control recipe is modified, the PID recipe will be saved while PID control is running, and new setting will take effect immediately and affect the on-going pressure control process. However, the accumulated integral errors will not be reset to zero for the PID control. If resetting of integral error is desired, one must reset the PID control.

### 6.7.3.2 Set Ratio Control of System Pressure using Multiple MFCs

Often the time, it is required to maintain the system pressure while keeping the gas compositions unchanged such as in a reactive sputtering process. This can be achieved by utilizing the ratio control function built in the 946 Controller. To operate the 946 in Ratio PID control mode, it is required to setup both PID and Ratio recipes before you can activate the ratio control.

The 946 Controller is capable of simultaneously manual or automatic ratio control of up to 4 MFCs since at least one slot will be taken by the pressure control board to measure the system pressure.

#### 6.7.3.2.1 Set the Recipe for Ratio PID Control using Multiple MFCs

The procedure for setting the recipe for Ratio PID control using multiple MFCs is nearly identical to as described in §6.7.3.1.1. The only exception is that the PID Ch becomes Rat as shown in Figure 6-19.

During ratio PID control using multiple MFCs, the full range for these MFCs might be different. Therefore, the Base, Preset and Start settings are actually the percentage of the full scale flow rate of the master channel. The flow rates for rest of slave channels will follow the master channel to maintain the gas ratio unchanged.

Pressure Control Parameter Setting Recipe							
R1	R2	R3	R4	R5	R6	R7	R8
B1	B2	C1	C2	Rat	VLV	NA	NA
PID Ch	Rat	P Ctrl Ch		A1	P Sp	5.0E+2	
Prop - Kp		1.0E+1		CtrlStart		10s	
Integral - Ti		1.0E+1		Start		0.0%	
Derivative - Td		1.5E+0		End		30.0%	
Base		0.0%		Ceiling		100.0%	
Direction		Upstream		Preset		30%	
GainSchedBand			0%	SchedGainCoeff		1	





Figure 6-19 Multiple MFC PID Ratio Control Recipe Setup Screen



The Base, Ceiling, Preset, Start and End are the percentage of the full scale flow rate of the master channel, not the actual flow rate.

### 6.7.3.2.2 Edit the Ratio Recipe for Ratio PID Control using Multiple MFCs

When multiple MFCs are used for ratio control of the system pressure, the Ratio recipe must be defined first. This recipe determines the concentration (ratio) for different gas species, and the starting flow rate for the ratio control. To access Ratio recipe edit screen, and turn it into editing mode, one can follow following steps:

1. Press the  button, move the cursor to Ratio Recipe Edit as shown in Figure 6-4, then press  key to display the MFC Ratio Recipe screen;
2. Press  or  keys to select a desired recipe for editing or displaying (highlighted by grey background), then, press  key to enter the edit mode as shown in Figure 6-20.

MFC Ratio Recipe			
RR1	RR2	RR3	RR4
RR1	RR2	RR3	RR4
Channel	Ref flow	%	Range
A1	NA		NA
A2	NA		NA
B1	1.00E+2	20.0	5.00E+2
B2	0.00E+0	0.0	2.00E+2
C1	0.00E+0	0.0	1.00E+3
C2	4.00E+2	80.0	1.00E+3

**Figure 6-20 Ratio Recipe Setup Screen for Multiple MFC Based Pressure Control**

There are 4 ratio recipes (RR1 to RR4) that one can define in a 946 Vacuum System Controller. While editing the recipe, the active ratio recipe is highlighted by the gray background such as the RR2 shown in Figure 6-20. The MFC boards are detected automatically, and their corresponding flow range (not the nominal range) will be displayed as well to assist the selection of correct flow rate.



**When either manual or auto Ratio PID control is active, parameters associated with the active Ratio recipe cannot be changed. In order to change the ratio recipe for the active control, you must stop the dynamic ratio control first. Certainly, one can still change the parameters associated with other 3 non-active recipes.**

The Ref flow is the reference flow rate for the ratio control. It is used to determine the gas ratio of the control, and also serves as the starting flow set point for the ratio control. If the Ref flow value is set to zero, this MFC will be excluded from the dynamic ratio control. Only a channel with non-zero Ref flow setting will be included in the ratio control automatically. The gas concentration (%) is calculated and displayed automatically after the initial flow rates are entered.



**The gas concentration displayed in Figure 6-20 may not be true gas concentration in the system as it does not include the gas flow rate for the MFCs that are not included in the ratio control. For example, in Figure 6-20, Channel B2 and C1 are not included in the ratio control, however, they can still be operated under the fixed set point operation mode.**

MFCs that are set to ratio control operating mode are tied together during the ratio pressure control process. The flow rates for all ratio controlled MFCs vary (either increase or decrease) simultaneously at the same rate. This operating mode can maintain the composition of different gases during the process even though the total flow rate may change in order to maintain the system pressure at the control set point. This technique is widely used for processes such as reactive sputter processes.

During the ratio control of system pressure, a master channel is assigned, and the flow rates for rest of slave channels will follow the master channel (set point value) to maintain the gas ratio. In order to achieve best control stability, the channel with maximum absolute flow rate is set internally as the master channel for the ratio control. For example, channel C2 is the master channel for the ratio control in Figure 6-20. However, if two MFCs have the same highest flow rate set point, the first channel in the order of A1→A2→B1→B2→C1→C2 will be selected as the master channel internally.

The maximum gas flow rate for a MFC is limited by its full scale and this, in turn, limits the settings for the ratio control of gas flow. In 946 ratio control, the range for flow control initial set point is limited to be less than 50% of the full scale. This enables a scaling of 0 to 200% in flow rate for all MFCs during the for ratio control of system pressure. Because of the range limitation (50% of the full scale) of the reference flow set point and scaling limit (200%) for flow control, the maximum gas flow will never surpass the full scale of the MFC during the dynamic ratio pressure control.

### 6.7.3.2.3 Manual Ratio vs Auto Ratio Control

There are two operation modes for ratio control using multiple MFCs: Manual and Auto ratio controls.

During the manual ratio control mode, there is no PID control being involved, and the flow rate can be decreased by pressing ◀ or increased by pressing ▶ key. Since manual ratio is often used for optimizing the initial set point values for an automatic PID ratio control, the PID recipe must be defined as well before one can activate the manual ratio control.

During the auto ratio control using multiple MFCs, the flow rates for MFCs will be adjusted automatically based on the system pressure. If the pressure reading is below the set point, flow rates will be increased simultaneously for all ratio channels to increase the system pressure, and vice versa.

### 6.7.3.2.4 Activate and Terminate the Multiple MFCs Auto/Manual Ratio Control

After both ratio and PID recipes are properly set, you can start to use multiple MFCs to control the system pressure. To active the ratio control, you need to

- Press the Pressure Control  key (you may need to press this key 2-3 times) until Ratio Control dialog box is displayed as shown in Figure 6-21;
- Select the appropriate Ctrl Recipe for the ratio control. Only valid Ratio control recipe will be displayed.

When a valid ratio PID control recipe is selected, the pressure set point (P set point in Figure 6-19) will be displayed on the front panel (such as 4.0E+2 as shown in Figure 6-21) to indicate the gauge being used for pressure control, and assist the comparison between the real pressure reading and the set point value.

- Select the appropriate ratio recipe. Once a ratio recipe is selected, the corresponding gas concentrations (such as 20.0% for B1, and 80.0% for C2 as shown in Figure 6-21) associated with the ratio control channel will be displayed to provide the indication of active ratio channel and corresponding ratio settings.

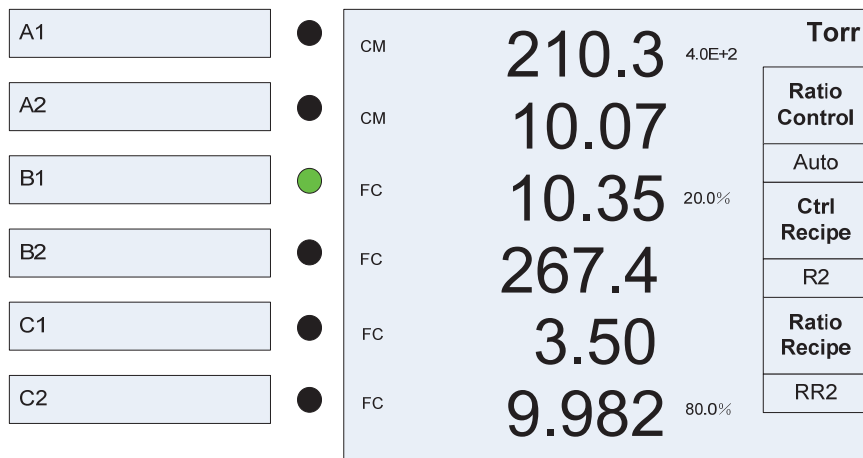

**Figure 6-21 Front Panel Display with the Dialog Box for Ratio Control using Multiple MFCs**

- Change the Ratio Control parameter from OFF to Auto to start the PID auto Ratio control, or to Manual to start the Manual ratio control. Once ratio control starts, the color of the readings for flow rate associated with the active ratio channels and pressure associated with the control will turn into blue for the easiness of identification as shown in Figure 6-22. If the gas flow rate is >2% of full scale and 20% off the target setting, the flow rate reading will turn into red to provide an alarm for the ratio control.

When PID Control is set to ON, the flow set point values for these ratio channels will be adjusted automatically to achieve the desired system pressure. At the beginning of ratio control, the MFC may reach maximum flow in order to reach the set point pressure. It is recommended to run the manual ratio control first to determine the optimal starting flow rate to avoid such an overshoot in flow and pressure.



**Both the PID and Ratio recipes (such as R2 and RR2 as shown in Figure 6-21) cannot be changed when either Auto or Manual ratio control is running.**

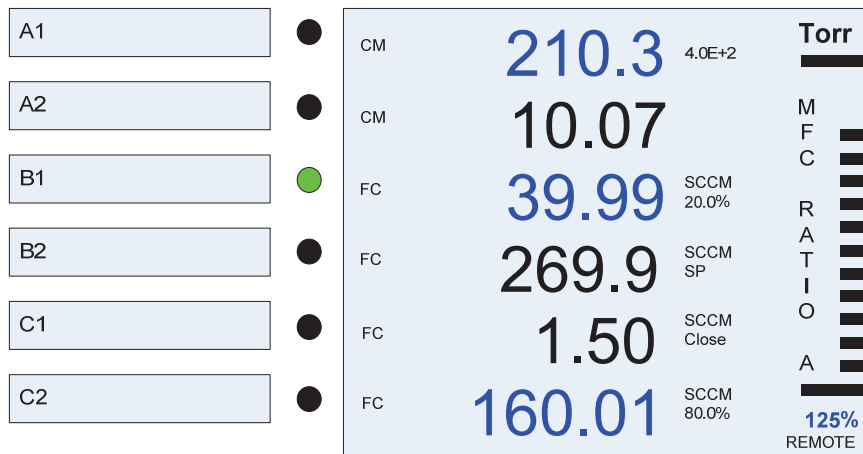

**Figure 6-22 Front Panel Display during Ratio Control using Multiple MFCs**

#### 6.7.3.2.5 Terminate a Ratio Control

To terminate a PID ratio control using multiple MFCs, unlike the signal MFC PID control, you cannot terminate the PID ratio control by stopping the individual channel control. You must switch either Manual or Auto ratio control to OFF to terminate the ratio control via the dialog box for ratio control as shown in Figure 6-21.

### 6.7.3.3 Switching Between Different Control Modes/Recipes

Since many parameters are involved in the dynamic control of the system pressure using MFCs, the PID/Ratio control must be terminated first before switching recipes. Once the control is stopped, all the MFC will be set to the control mode defined by the Preset inside the recipe. If the Preset value is zero for an MFC, this MFC will be set to Close mode when the PID/Ratio control is terminated.

However, switch between Manual Ratio and Auto Ratio is allowed without terminating the control as same ratio recipe is used.

## 6.8 Pressure Control using a Control Valve

The system pressure can also be controlled utilizing a control valve. Either an upstream solenoid control valve on a delivery line or a downstream throttle valve on the vacuum foreline can be used for controlling the system pressure. When an upstream control valve is used, large opening of the valve leads to high gas flow rate into the system, therefore, higher pressure in the system, when a downstream valve is used, larger valve opening results in higher pumping speed of the vacuum system, therefore, lower pressure in the system.

When upstream valve is used, only one valve, therefore, one type gas flow can be adjusted to achieve desired pressure set point. When downstream throttle valve is used, the upstream gas flow rate is fixed, and the pressure is controlled by adjusting the opening of the throttle valve.

Once a valve control board is resided inside a 946 controller, the board will be detected, and the 946 Front Panel Display will be switched to as shown in Figure 6-23 automatically.

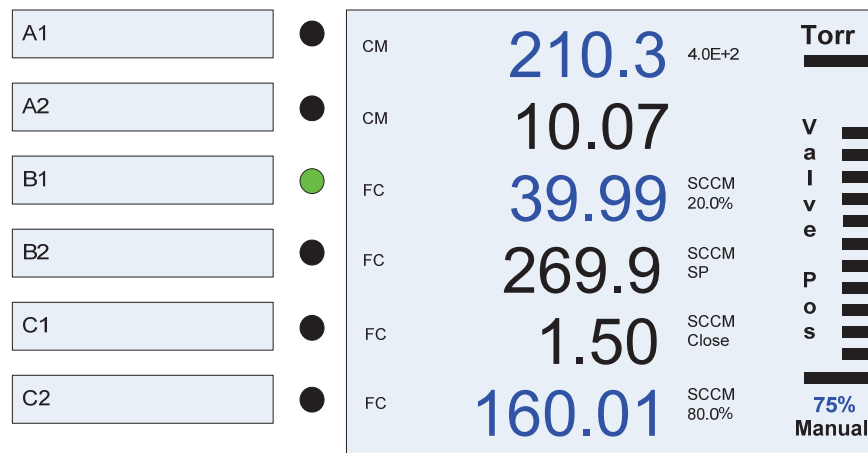

Figure 6-23 946 Display with a Pressure Controlled being Resided in the Controller



The position displayed on the front panel for an upstream solenoid valve is actually the percent of the full scale driving current of the valve, not the true opening position of the valve. Often the time, a 20-40% of the full scale driving current is required to open the valve, that is, to overcome the spring sealing force of the valve.

## 6.8.1 Valve Type Selection





Correct valve type must be selected first before performing any valve based pressure control due to the fact the different valve demands different power supplies, and involves different control mechanism. Following is list of valves that can be connected to the 946 pressure control board:

- Voltage driven Throttle Valves (MKS 153/T3B): This valve is installed on the vacuum foreline downstream of a process chamber (also called downstream control valve). Therefore, larger valve openings produce lower chamber pressures.
- Proportional current driven valves (MKS 148, 154 and 248): These valves are often installed on the delivery line of a process chamber, therefore, they are also called upstream control valves. When these valves are used, larger valve openings produce higher chamber pressure.



**When an upstream valve is used to control the vacuum system pressure, the valve inlet pressure should be regulated to ensure stable pressure control. If the control system pressure is low (say, below  $10^{-4}$  Torr where ion gauge is used to monitor the pressure), the inlet pressure should be regulated at similar pressure range, or a small leak valve (orifice) should be installed to avoid the pressure burst during the control, which may destroy ion gauge rapidly.**

Please refer Figure 6-24 and use following steps below for selecting the valve type on a 946 vacuum system controller:

1. Press  key on the front panel to display the system setup screen as shown in Figure 6-24;
2. Move the cursor using  or  keys to highlight Valve Type parameter;
3. Press  key to enter the edit mode;
4. Select appropriate valve type, and press  again to save the setting.



System Setup			
P Unit	Torr	CommType	RS232
Address	253	Baud Rate	9600
Com Mode	946	Parity	None
Set Param	Enable	User Cal	Enable
PID Recipe	Edit	Ratio Recipe	Edit
Valve Type	248		
Combination Setup	Edit		
DAC Parameter Setup	Edit		
System FV Infor	Display		

**Figure 6-24 Selection of Valve Type using System Setup Screen**

## 6.8.2 Valve Control Recipe Setup



During the process of pressure control using a valve, the opening of the valve is dynamically adjusted based on the feedback of the system pressure. PID control logic is used for the control, therefore, all the controlling parameters need to be defined by a recipe, similar to that being used for MFC based PID/Ratio control.

To edit and set a PID recipe for valve control, following steps are required to enter the editing mode for PID recipe:

1. Press the  button, move the cursor to PID Recipe Edit as shown in Figure 6-4, then press  key to display the Pressure Control Parameters Setting Recipes screen as shown in Figure 6-25;

Pressure Control Parameter Setting Recipe							
R1	R2	R3	R4	R5	R6	R7	R8
B1	B2	C1	C2	Rat	VLV	NA	NA
PID Ch		Vlv		P Ctrl Ch		A1	P Sp
5.0E+2							
Prop - Kp		1.0E+1		CtrlStart		10s	
Integral - Ti		1.0E+1		Start		0.0%	
Derivative - Td		1.5E+0		End		30.0%	
Base		0.0%		Ceiling		100.0%	
Direction		Upstream		Preset		30%	
GainSchedBand		0%		SchedGainCoeff		1	

Figure 6-25 Recipe Setup Screen for PID Control using a Valve

2. Press  or  keys to select a desired recipe for editing or displaying (highlighted by grey background), then, press  to enter the edit mode;
3. Move the cursor to the PID Ch, and set its parameter to Vlv;
4. The rest of the parameter settings are identical to that are described in §6.7.3.1.1.

Please note that the value for Base, Ceiling, Preset, Start and End are the percent of opening of the valve ( $\leq 100\%$ ).

## 6.8.3 Activate a Pressure Control using a Valve

### 6.8.3.1 Simple Valve Operations (Static Valve Control)

Simple valve operations (static valve control) are Open, Close, manual, and Set Point that do not involved dynamic PID control. Since the valve control board is inserted into the COMM/VLV slot, no channel selection with LED display is available. One needs to press  button on the front panel to perform valve static control.

To active these simple valve operations, please following steps below:

1. Press the  button to the front panel display with valve control dialog box as shown in Figure 6-26. Please note that this screen will not show up if no pressure control is inserted in the COMM/VLV slot.



- For Open and Close operation, move the cursor to OP Mode, and change the parameter to either Open or Close, or just simply press the  or the  button on the front panel, and  afterward to confirm the operation.
- For Set Point control the valve (set the valve opening to specific position), it is required to (1) set an appropriate value for Set Point (such as 20.0% in Figure 6-26), and (2) change the OP Mode to Set Point, or just simply press the  key, and press  key afterward to confirm the operation. Note that the set point value can be adjusted lively under the Set Point OP Mode without stopping the Set Point control.
- Manual operation mode enables the dynamic manual adjusting the valve position. Once the manual operation mode is selected, the dialog box as shown in Figure 6-26 will disappear, the

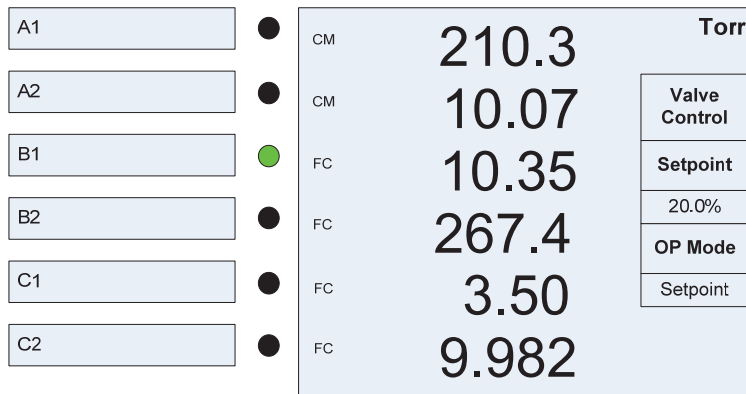

Figure 6-26 Front Display with Valve Control Dialog Box

### 6.8.3.2 PID Dynamic Valve Control

Once valve type is properly selected, and recipe is configured, a 946 Vacuum System Controller can now activate a dynamic PID pressure control process using a valve.

The activation of a PID dynamic valve control process is identical to activate a PID control using single MFC as described in §6.7.3.1.2. The only exception is that the PID Ch becomes Vlv as shown in Figure 6-27. Once a proper recipe is selected, one can activate a PID pressure control process using a valve by changing the PID Control parameter from OFF to ON.

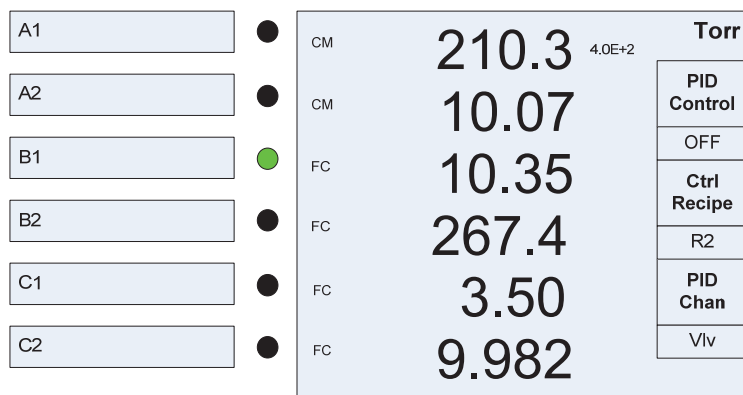

Figure 6-27 Front Panel Display with the Dialog Box for PID Control using a Valve

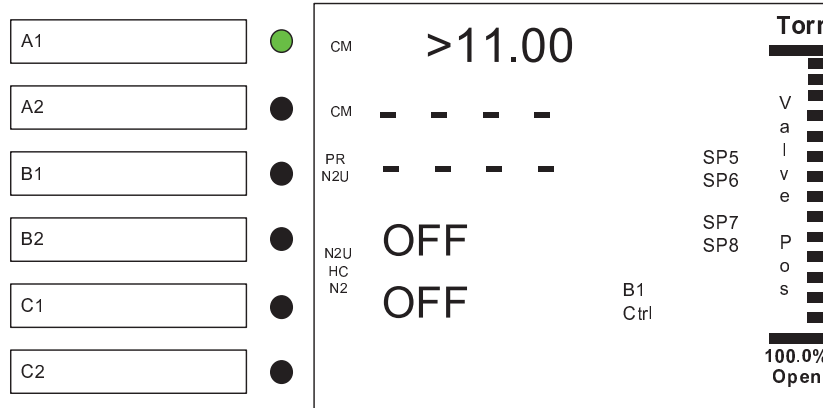





Figure 6-28 Front Panel Display for PID Control using a Valve

Once the PID control started, the valve position will be displayed on the front panel both digitally and graphically, as shown in Figure 6-28.



### 6.8.4 Terminate a PID Pressure Control using a Valve

To terminate a PID dynamic pressure control using a valve, you can choose any one of the following approaches depending upon your termination condition:



1. Close the valve:

If you want to close the valve, press the  key until front display is as shown in Figure 6-26, move the cursor to OP Mode, and change the parameter to Close, or just simply press the  button, and press the  key afterward to confirm the operation.

2. Open the Valve:

If you want to open the valve, press the  key until front display is as shown in Figure 6-26, move the cursor to OP Mode, and change the parameter to Open, or just simply press the  button, and press the  key afterward to confirm the operation.

3. Set the valve to fixed position defined by the set point as shown in Figure 6-26

If you want to set the valve to fixed position, press the  key until front display is as shown in Figure 6-26, move the cursor to OP Mode, and change the parameter to Set Point, or just simply press the  button, and press the  key afterward to confirm the operation.

4. Set the MFC to the set point defined in the recipe (Preset)

- Press the  to display the PID Control dialog box as shown in Figure 6-27;
- Switch the PID Control parameter from ON to OFF as shown in Figure 6-27. Once the PID control is turned off, the valve position will be changed to the Preset set point as defined in the recipe as shown in Figure 6-14.



# 7 Installing Vacuum Sensors

## 7.1 Installing Cold Cathode Sensors

### 7.1.1 Locating a Cold Cathode Sensor

Locate Cold Cathode sensors in a position suitable for the measurement process chamber or manifold pressures. Install the sensor away from pumps, gas sources, and strong magnetic fields to ensure the most representative data. Place and orient the sensor such that contamination is unlikely. For example, if a sensor is installed directly above a diffusion pump oil vapor can contaminate the cathode, anode, and other vacuum wetted components, causing calibration drift.

### 7.1.2 Orienting a Cold Cathode Sensor

A Cold Cathode sensor can be installed with the body set in any direction. The operating position does not affect accuracy. That being said, installation with the vacuum port facing down is preferable since this helps to prevent contaminants from falling into the sensor.

### 7.1.3 Managing Contamination in a Cold Cathode Sensor

Do not operate a Cold Cathode gauge at pressures above  $10^{-3}$  Torr for extended periods. This will increase the likelihood of contamination due to high sputtering rate at high pressure. If pressure readings appear erratic, the sensor tube may be contaminated. In such a case, the tube should be visually inspected and, if contamination is visible, the internal components should be replaced using an Internal Rebuild Kit.

Depending on the degree of contamination and application, the internal parts may need to be cleaned.

### 7.1.4 Connecting the Series 431/422 Sensor

The Series 431 Cold Cathode sensor and Series 946 Controller are connected using coaxial cables with SHV and BNC connectors as shown below.

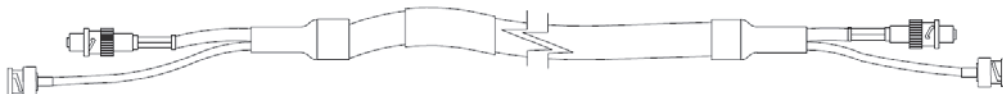

**Figure 7-1 431/422 Cold Cathode Cable**

The Series 422 Cold Cathode gauge is same as 431 except that its end has LEMO connectors.

Connect the SHV and BNC connectors to their respective connectors on the rear panel of the Controller – H.V. (SHV connector) and Ion Current (BNC connector).

If there is any potential for stress on the cable, use separate strain relief to avoid damage to the sensor, cable, or the Controller.

Cables are available from the factory in standard lengths of 10, 25, 50, and 100 feet and in custom lengths up to 300 ft.

Some applications may require the use of special cables, such as when the connection must be routed through restrictive barriers or through a conduit. Custom cables can be fabricated for these situations. Use SHV and BNC connectors for all applications.

## 7.1.5 Connecting the 423 I-MAG Sensor

Mount the sensor to a grounded vacuum system.

If the I-MAG Sensor has a CF flange, remove the magnet first to allow clearance for bolt installation. When replacing the magnet, note that it is keyed to the sensor body to protect the feed-through pins from damage. The pins should be straight and centered.

Use a conductive, all-metal clamp to mount a KF 25 or KF 40 flanged sensor body for grounding.

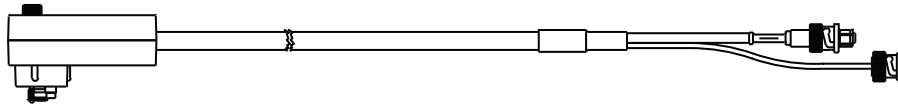

Figure 7-2 423 I-Mag Cold Cathode Cable

Connect the cable to the sensor and to the Series 946 Controller before turning on your system. Tighten the thumbscrew on top of the cable to make sure that it is securely in place.

## 7.2 Installing Hot Cathode Sensors

### 7.2.1 Locating a Hot Cathode Sensor

Locate the sensor in a position appropriate for the measurement of process chamber or manifold pressure. Installing the sensor away from pumps and gas sources gives the most representative pressure measurement. In the case of a nude gauge, ensure that there is nothing in the system or mounting location that could damage the electrode structure of the gauge. Special consideration should be given to any moving mechanism within the vacuum system to insure that they cannot inadvertently damage the sensor.

### 7.2.2 Preventing Contamination in a Hot Cathode Sensor

Locate the sensor where contamination is least likely. For example, if the sensor is mounted directly above a source of evaporation, the vapor could contaminate the structure or feed-through and cause calibration shift.

### 7.2.3 Orienting a Hot Cathode Sensor

A Hot Cathode sensor can be installed and operated in any direction without compromising the gauge accuracy. However, it is recommended that, whenever possible, the sensor be installed with the vacuum port facing down to keep contaminants from falling into the sensor.

### 7.2.4 Connecting a Hot Cathode Sensor to the Vacuum System

HPS® Products sensors are available with either a CF type metal sealed flange, a KF type flange, or tabulation. Note: attaching gauges with compression type (quick connect) adaptors on a tabulation is discouraged since, in an overpressure condition, the gauge could be forced out of the adaptor and thus constitute a safety hazard. Additionally, the use of an elastomer seal is not recommended for high vacuum as outgassing and/or permeation through the elastomer can cause errors in pressure measurement. A sensor with a KF flange and elastomer O-ring seal is suitable only for pressure measurement down to  $1 \times 10^{-7}$  Torr.

When inserting a nude sensor into a port, do not bend, damage, move the electrodes or feed-through pins. Do not short the elements to one another, the chamber, or any components inside the chamber. If there is any question of clearance for the electrode structure or of possible damage to the electrode structure, it is recommended that the nude gauge be mounted in a nipple, (i.e. HPS® Products Part Number 100883069). The HPS® nipple includes a screen that helps to prevent ion coupling. This mounting is also recommended to assure the nominal rated sensitivity of the gauge.



The outside of the nipple can get hot and may burn the skin.

## 7.2.5 Connecting a Hot Cathode Sensor to the 946 Controller

A sensor cable with a 13 pin D-Sub connector (**Figure 7-3**) is required for operation and this must be purchased separately from the 946 Controller System.

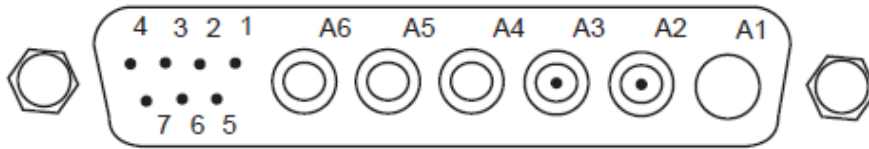

**Figure 7-3 13 Pin D-Sub Connector on the Back of 946 HC Board**

The pin out for the Hot Cathode Connector is described in Table 7-1.

Pin #	Description
1	Emission current out
2	Emission current in
3	Factory test
4	Factory test
5	Sensor detect
6	Sensor detect common
7	Sensor detect
A1	Not used
A2	Collector current
A3	Grid
A4	Filament 2
A5	Filament common
A6	Filament 1

**Table 7-1 Hot Cathode Connector Pin Out**

Pins 5, 6, and 7 are used for sensor identification. Therefore, cable needs to be selected to enable the proper operation of the Hot Cathode sensor. The setting of these pins for different hot cathode sensors is described in Table 7-2.

Figures 7-4 and 7-5 show the cable diagrams for Low Power Nude gauge and Mini BA gauge, respectively.

Since much high power is required to operate Hot Cathode gauge, especially, during degas process, the maximum allowed cable length of a Hot Cathode is restricted to less than 50 ft (15 m), which is significantly shorter than that is allowed for operating a cold cathode sensor.

Sensor	Pin 5	Pin 7
LPN	Ground	No Connection
Mini BA	No Connection	Ground
Glass BA	Ground	Ground
UHV-24	No Connection	No Connection

**Table 7-2 Pin Assignment for HC Sensor Type Identification**

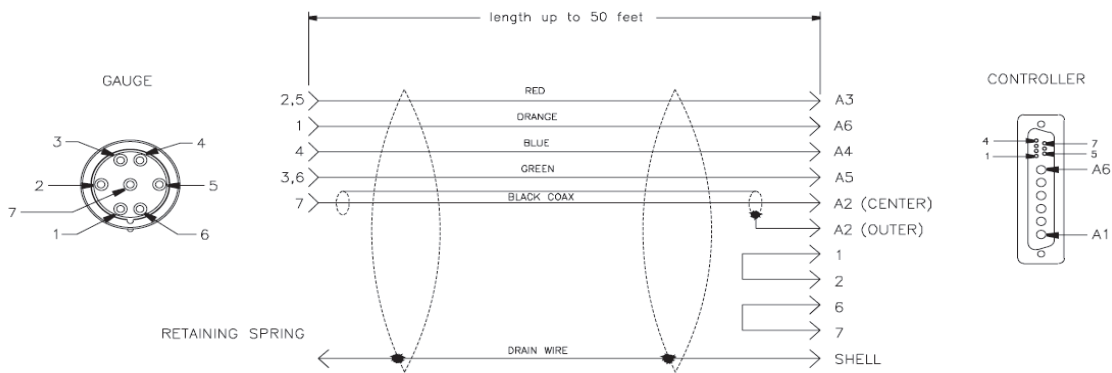

**Figure 7-4 LPN Gauge Cable Diagram**

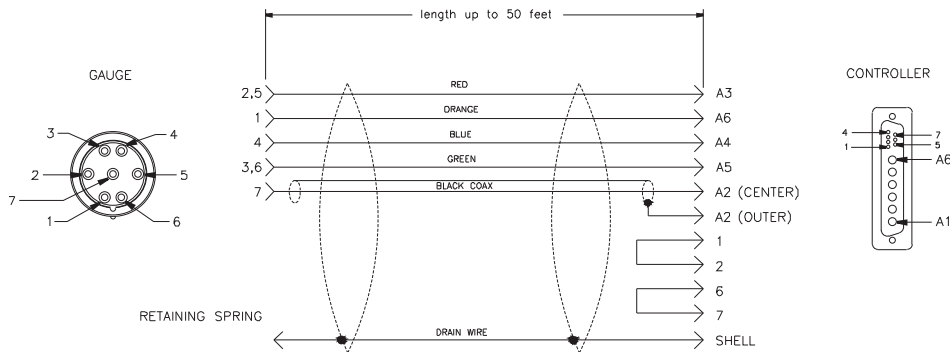

**Figure 7-5 Mini BA Gauge Cable Diagram**

When exerting force on the cable, use a separate strain relief to prevent damage to the sensor or controller. Cables are available in standard lengths of 10, 25 & 50 feet only. Connect the cable to the rear of the controller at the sensor module port labeled “Hot Cathode”. Tighten the cable jackscrews into the mating screw locks to ensure proper electrical connection and prevent stress on the connector.



**Remove power from the controller before connecting or disconnecting the cable from the sensor or controller.**



**Hot Cathode cables have several special characteristics, including lethal voltages, therefore only cables supplied by HPS® Products should be used.**

## 7.3 Installing Pirani Sensors

### 7.3.1 Locating a Pirani Sensor

Locate a Pirani sensor appropriately for measuring a chamber or manifold pressure. Install the sensor away from pumps and gas sources for the most representative data. Place the sensor in a location with minimal vibration.

### 7.3.2 Preventing Contamination in a Pirani Sensor

Locate and orient the Pirani sensor so as to avoid contaminants that might affect the tube's element. For example, if a sensor is installed directly above a roughing pump oil vapor could contaminate the tube's filament wire and cause calibration shift.

Install a Pirani sensor with the vacuum port facing downward whenever possible. This helps to prevent particulate and liquids from falling or flowing into the sensor. The use of a screen or porous filter at the port can be helpful (i.e. a HPS™ Product seal and centering ring assembly with screen).

### 7.3.3 Orienting the Series 317 Pirani Sensor



**When measuring pressures greater than 1 Torr, the Series 317 Sensor must be mounted with its axis horizontal.**

Measurements below 1 Torr are unaffected by position, but readings will be incorrect at higher pressures. Incorrect readings could result in under- or over-pressure, damaging equipment or injuring

Mount the Sensor with the vacuum port facing downward to reduce particulates and liquids falling or flowing into it. The sensors are calibrated in this position.

### 7.3.4 Orienting the Series 345 Pirani Sensor

Operating position has no effect on accuracy. The Pirani Sensor was designed to minimize the effects of convection. In a standard Pirani system, the output of the sensor changes very little in going from the horizontal to vertical position.

The Series 345 Pirani Sensor exhibits slight convection characteristics near atmospheric pressure. Therefore, above 30 Torr the best accuracy can be achieved by calibrating the sensor in a vertical position with the port facing down. The Pirani Sensor can be calibrated at any pressure between 600 and 1000 Torr.

### 7.3.5 Connecting the Series 317/345 Sensors

Use an HPS® adaptive centering ring (HPS® PN 100315821) to fit a KF 16 port to a KF 10 port.

To install the sensor with a 1/8" NPT, do not apply torque to the case to tighten the connection. The sensor's vacuum tubing has 9/16" hex flats for tightening. Wrap about two turns of Teflon® tape on the threads of the Sensor in the direction of the threading to ensure a leak-free seal. Note: positive pressures can blow the Sensor out of a compression fitting, damaging equipment and possibly injuring personnel.

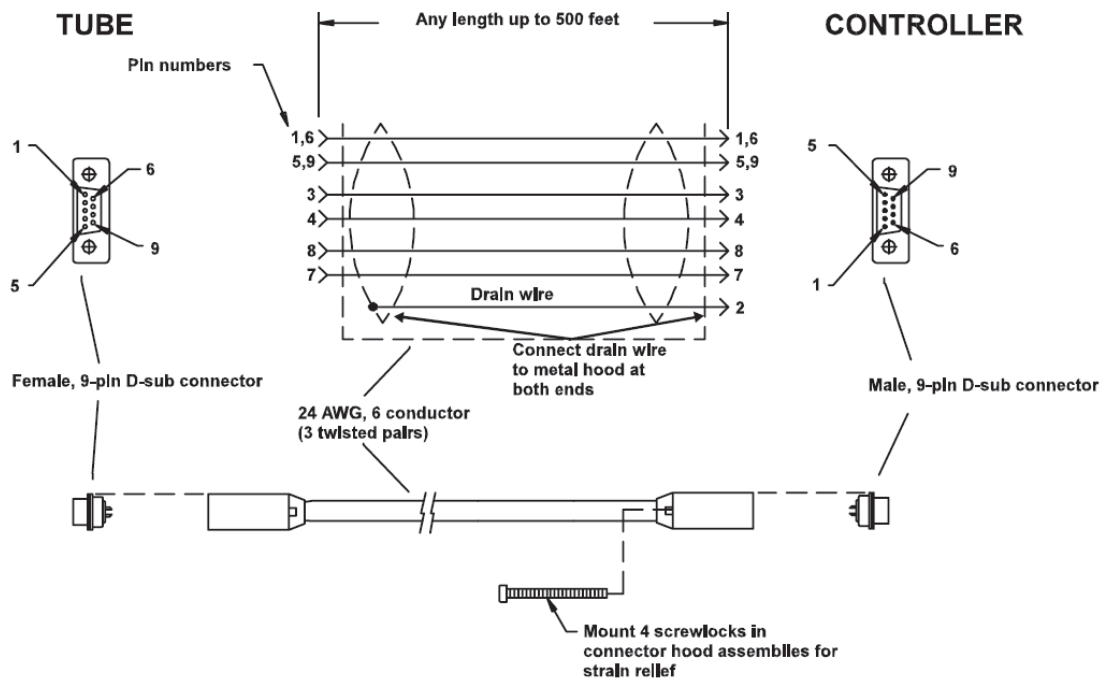

Figure 7-6 317/345 Cable Diagram





**Do not use a compression mount (quick connect) to attach the sensor to a system in positive pressure applications.**



**A solid electrical connection between the sensor and the grounded vacuum system must be provided to shield the tube element from external radiation sources.**

In applications where the system may be exposed to large voltage fluctuations, a centering ring with a screen should be installed, and the screen and tubing grounded. The clamp must be tightened properly so that the flange contacts the centering ring.

The sensor cable is connected to the 946 Controller with the 9-pin "D" connector as shown in Figure 7-4. This connector is equipped with integral strain relief. Screw the strain relief into the mating standoffs on the rear of the Controller for good contact and to avoid excess stress on the connectors.

If excess stress is applied to the cable, use separate strain relief to prevent damage to the sensor, cable or the Controller. Cables are available from HPS™ in standard lengths of 10, 25, 50, and 100 feet and in custom lengths up to 500 feet.

Some applications, (i.e those in which the connection is routed through restrictive barriers or a conduit) may require the use of special cables. Custom cables may be fabricated for these situations using the information provided below. The maximum length of the sensor cable is 500 feet. Use a "D" connector with integral strain relief for all applications.

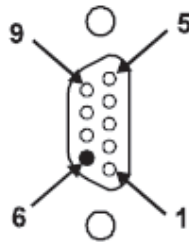

Pin	Description
1,6	Bridge drive +
5,9	Bridge drive -
2	Chassis ground
3	Signal +
4	Signal -
7	Bridge sensor leg
8	Bridge reference leg

**Table 7-3 Pin out for 317/345 cables.**

### 7.3.6 Preparing the 317 Sensor for Bakeout

Remove the cable from the Sensor. Using a #1 Phillips screwdriver, remove the two screws at the end of the connector/electronics subassembly separating it from the Sensor. The standard Convection Pirani sensor can be baked up to 150°C and the Shielded Convection Pirani sensor can be baked up to 100°C. A new 317 with aluminum housing RF shielding can be baked to 250°C.

## 7.4 Installing Capacitance Manometers - MKS Baratron

The Series 946 Controller supports a number of Capacitance Manometers, including the MKS unheated Baratrons® (622A, 623A, 626A, 722A ), and MKS 45 C heated Baratrons® (624B,D24B, 627B,D27B). Capacitance Manometers measure pressure directly by measuring the deflection of a thin Inconel® diaphragm. Baratrons are widely used owing to their accuracy and reliability. They are available in full scale ranges from 0.02 to 10,000 Torr, each with a 3-decade range.

See an MKS Baratron instruction manual for complete information on using these capacitance manometers.



Do not connect heated Baratrons with controlled temperatures higher than 45°C. It may damage the Baratron Module.

### 7.4.1 Installing a Baratron Capacitance Manometer

Capacitance Manometers may be mounted in any position, however, it is recommended that they be placed a system with the Px port facing down to allow contamination to fall away from the pressure sensing diaphragm. Any standard vacuum fitting may be used to connect the Baratron to the system (VCR®, compression, KF flange, etc.). The sensor port will easily carry the weight of the transducer.



Due to the failure of many users to follow the proper tightening procedures for single or double metal ferrule compression vacuum fittings and the resulting damage to the pressure sensor, MKS does not warrant this product when such fittings are used.

### 7.4.2 Connecting a Baratron™ Capacitance Manometer

A Capacitance Manometer head is connected to the module with a multiconductor shielded cable. The module has two female, 9-pin "D" connectors. The Pin assignment for the 9-pin D-Sub connector is shown in Table 7-4.

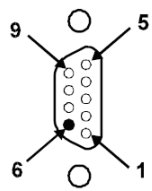

Pin	Description
1	-15 V
5	+15 V
6	chassis ground
7	signal -
8	signal +
9	±15 V return

Keyed "D" connector for capacitance manometer

Table 7-4 Pin Out of the 9 Pin D-Sub Connector on CM Module.

A shielded cable with 9 pin male D-sub on the controller end and a 15 pin male D-sub end on the Baratron end is required to connect the Baratron to the module on the 946 Controller. Detailed wiring for the cable is shown in Figure 7-5.

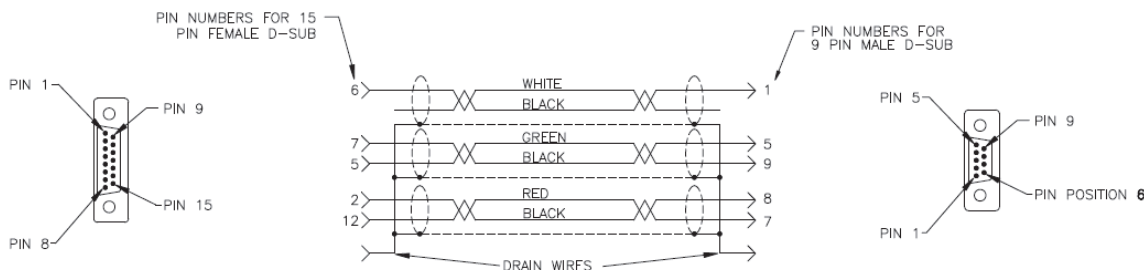

### 626/627 Capacitance Manometer Series

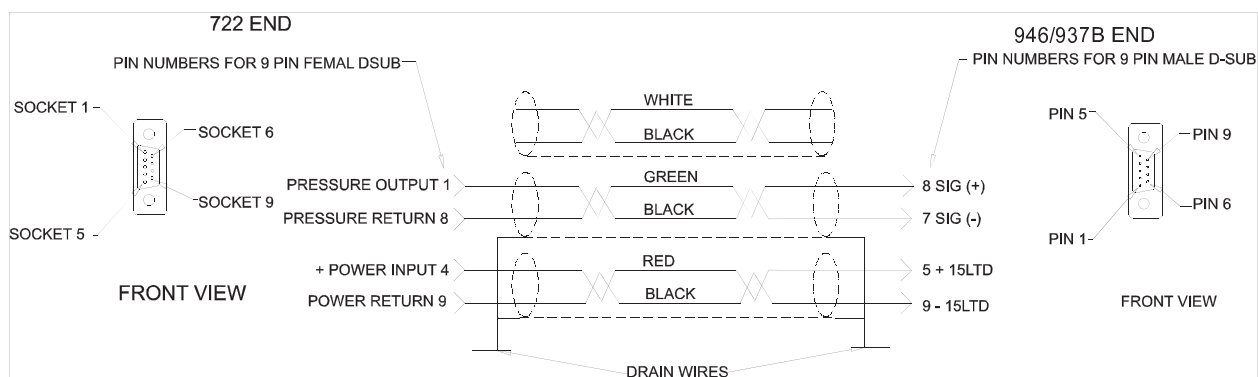

**722 Capacitance Manometer Cable**

**Figure 7-7 Wiring Diagram for the Capacitance Manometer Cable**

## 7.5 Installing Mass Flow Controllers

Series 946 Controller can operate six mass flow controllers simultaneously. These include MKS 1179, 1479, 2179, 1559, M100B and P4B analog MFCs, and 179, M10MB mass flow meters.

### 7.5.1 Environmental requirements

Follow the guidelines listed below when installing and using a mass flow controller.

1. Maintain the normal operating temperature between 0° and 50° C (32° and 122° F).
2. Observe the pressure limits:
  - A. Maximum gas inlet pressure is 150 psig.
  - B. Operational differential pressure is:
    - 10 to 40 psid for ≤ 5000 sccm units
    - 15 to 40 psid for 10,000 to 30,000 sccm units
3. Allow 2 minutes for warm-up time.
4. Use high purity gas and filters in line upstream of the MFC.
5. Leave the power to the instrument on at all times, for optimal performance.

### 7.5.2 Interface Cables

Connect the MFC and 946 Controller using MKS cables for Mass Flow Controller using MKS cables (100016744, 100016745, or 100016746). These are straight through cables with standard 15 pin D-Sub at one end (connecting to MFC), and high density 15 pin D-sub at other end (connecting to 946 MFC board).

Pin	946 15 HD/MFC 15pin D-sub
1	No connection
2	Signal In +
3	Valve Close
4	Valve Open
5	Power Common
6	-15 V
7	+15 V
8	Set point Signal output
9	No connection
10	Zero
11	Signal common
12	Signal common
13	No connection
14	No connection
15	Chassis ground

**Table 7-5 Pinout for 15 pin HD-Sub Connector on 946 MFC Board and 15 Pin D-sub on MFC**

### 7.5.3 Setup

1. Set the mass flow controller into position where it will be connected to a gas supply. Placement of flow components in an orientation other than that in which they were calibrated (typically horizontal) may cause a small zero shift. The zero offset can be removed by adjusting the zero potentiometer on the mass flow controller.
2. Install the flow controller in the gas stream such that the flow will be in the direction of the arrow on the side of the controller.
3. Allow adequate clearance for the cable connector and tubing (approximately 3" height).
4. Position the flow controller to provide access to the zero potentiometer. The zero potentiometer is located on the inlet side of the flow controller body.

### 7.5.4

#### 7.5.5 Gas Line Connections

Connect the gas line (via tubing) from the gas supply to the flow controller's inlet, and from the flow controller's outlet, to the downstream tubing. Standard Fittings for mass flow controller is equipped with Swagelok 4-VCR (or 8-VCR for high flow MFC) male compatible fittings.

### 7.6 Installing Pressure Control Valve

Either an upstream solenoid valve or a downstream throttle valve can be connected to the 946 to perform system pressure control. This feature requires the 946 to have the Pressure Control (PC) option installed. It should be noted that the control logic is opposite between upstream solenoid and downstream throttle valves, that is, a larger opening of an upstream solenoid valve leads to higher system pressure, while a larger opening of a downstream throttle valve leads to lower system pressure.

#### 7.6.1 Installing an Upstream Solenoid Valve

Only one upstream valve (148, 248, 154) can be controlled with the 946 Vacuum System Controller. If multiple gases are used for system pressure control, MFC based ratio control is recommended.

##### 7.6.1.1 Mounting of the Valve

- Ensure the flow direction arrow on the valve body is pointing to the vacuum chamber.
- The valve may be installed in any position, although base vertically down is recommended.
- Although ¼" O.D. tubing connections are generally adequate to support the weight of the valve, it is recommended to mount the valve on a base plate with the two 10-24 mounting holes on the valve body.
- Tubing lengths should be kept short throughout the flow control loop and restrictions and bends should be eliminated wherever possible.

##### 7.6.1.2 Inlet Pressure

- The 148/248/154 valve may be operated with 150 psig maximum inlet pressure, however, the nominal flow rating is established at 1 atmosphere differential across the valve, increasing the inlet pressure up to the maximum allowed. This extends the maximum flow control range from approximately 3X (10,000 sccm range) to 250X (10 sccm range).
- Decreasing the outlet pressure increases the flow range until the choked flow condition is reached. Further lowering of outlet pressure for a fixed inlet pressure will not increase flow because a sonic restriction exists.
- If low flow rate is desired (such as used in control the high vacuum system pressure), the inlet pressure must be regulated at very low pressure to avoid pressure burst inside the chamber during the valve operation, which may cause damage to the turbo pump.

### 7.6.1.3 Connecting the Valve to 946 Controller

- 100018192 cable can be used to connect an MKS 148/248/154 upstream valve to the 946 Vacuum System Controller. Its wiring diagram is shown in Figure 7-8. Only one valve can be connected to the controller to regulate the system pressure.

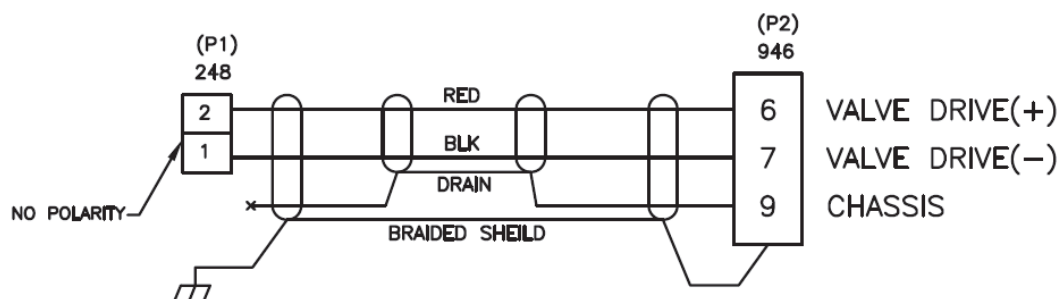

Figure 7-8 Wiring Diagram for 10018192 Cable

- If multiple gases are used for system pressure controller, MKS Mass Flow Controllers can be used to perform the ratio system pressure control.

The pinout for the connector on 946 pressure control board is shown in Table 7-6. When the pressure control board is used for controlling an upstream solenoid valve, only pin 6 and 7 are used.

Pin	946 9pin female D-sub on Pctrl board
1	Power common
2	+15V
3	Analog Set point (+)
4	Analog Set point (-)
5	PCS Signal
6	Valve drive (+)
7	Valve drive (-)
8	PCS Common
9	Chassis ground

Table 7-6 Pinout for the 9Pin D-sub on 946 Pressure Control Board

### 7.6.1.4 946 Setup

- When 148/248/154 valves are used for system pressure control, the valve type must be selected properly to match the valve being installed on the system setup screen as shown in Figure 6-24. In addition, the Direction in the PID recipe should be set properly (normally to UPSTREAM) as shown in Figure 6-25.

## 7.6.2 Installing a downstream MKS 153/T3B throttle valve

While inlet gas flow rate and system pumping speed are all fixed, the system pressure can be effectively controlled by adjusting the flow conductance using a downstream throttle valve such as MKS 153/T3B control valve. Because the valve is positioned between the vacuum system and the vacuum pump, larger opening of the valve leads to high conductance, therefore, lower system pressure. This logic is opposite the upstream pressure control where high opening often results in higher system pressure since more gas is fed into the vacuum system.

### 7.6.2.1 Mounting the throttle control valve

- The 153/T3B unit can be mounted in a vacuum exhaust line with the proper fittings and connectors. The unit consists of a 253 exhaust valve with an electronic housing attached to the motor plate. Although the unit was designed and tested to operate in the most extreme conditions (with no air circulation and a heated valve at 80° C), it will operate cooler if the air slots in the side

of the housing are clear to allow convection air circulation. Typically, electronic components last longer in cooler environments.

- For best pressure control, locate the pressure transducer and exhaust control valve as close as practical to the process chamber. This minimizes the time constants associated with these items.

### 7.6.2.2 Connecting the 153/T3B control valve to 946 controller

- 10018191 cable should be used to connect the 153/T3B control valve to 946 Vacuum System Controller.

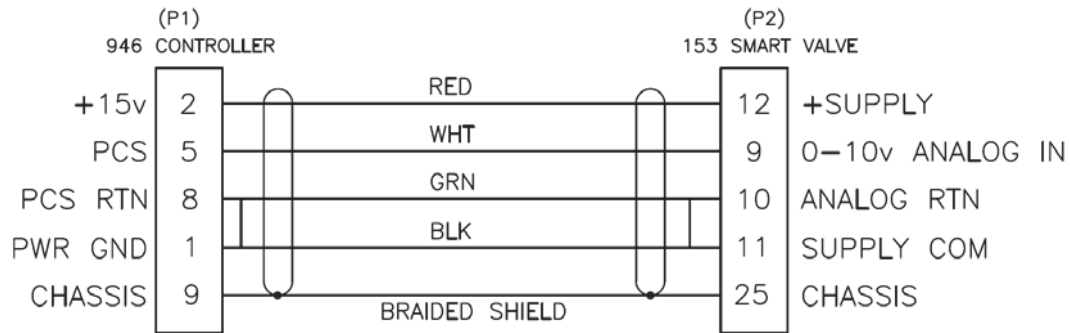

Figure 7-9 Wiring Diagram for 10018191 Cable

- Once the cable is connected, the 946 Controller will provide the power to the 153 valve, and position of the valve is controlled by the PCS signal voltage, as shown in Table 7-6.
- Use cable 1053451-001 to connect the T3B to the 946.

946 9 pin female PC	Description	T3BI 25 pin I/O female
5	Signal (+)	9
8	Common (-)	10

- Connect desktop power supply part number 1053192-001 to the T3B or DIN Rail power supply part number 1053456-001 to the T3B.  
Or connect +24 VDC 4 Amps to pins 1 and 2 and +24 VDC Return to pins 3 and 4 of the 9 pin power connector of the T3B.
- Connect the pressure sensor to the 946, not the valve.

### 7.6.2.3 Setting of 153/T3B Valve and 946 Controller

To ensure the 946 control the 153/T3B valve properly, both 153/T3B valve and 946 Controller need to be set as follows:

- 153/T3B valve control mode must be switched to Position Control mode.  
For the T3B, connect pin 5 to pin 24 on the Aux I/O connector.  
Additionally, ensure that the interlock signal is satisfied by connecting pins 22 and 24 on the Aux I/O connector.
- Valve type on 946 should be selected to 153 or T3B (see Figure 6-24 Selection of Valve Type using System Setup Screen. Figure 6-24).
- Direction in PID control recipe must be selected to DOWNSTREAM (see Figure 6-25).

## 8 Connecting Relay and Analog Outputs



Relay and analog outputs require 2.5 sec time delay to stabilize after power application.

### 8.1 Connecting 946 Relay Outputs

There are twelve relays available in the 946 Controller. These can be used to control the operation of devices (such as valves) associated with a vacuum system. Relays can be accessed through the 25 pin D-Sub connector on the back of the AIP module.

Relays used in the 946 are normally open (NO) SPDT relays. Thus if no is supplied to the controller, no output signal can be sent. During the 946 power up process, a delay circuit is implemented to ensure that all of these relays are disabled (i.e. maintained in the normally open state) until reliable control signals are available.

If normally closed relay outputs are required, an external conversion is required.

Currently, relay activations are determined using the main microprocessor in the 946. The time required to process a measured pressure signal therefore results in a relay activation time delay of between 50 to 100 msec.

Analog comparators that facilitate reduced relay response times will be added in future to ensure short relay response time (less than 5 msec). The main microprocessor will then be used only for setting the reference values for the comparators.

#### 8.1.1 Pin Out for the 946 Relay Output

Table 8-1 identifies the pins for the male, 25-pin "D" connector on the AIO/Power module that provides the connection to the relay output. 12 relays are built into the controller and 4 relays are assigned to each sensor module. If a single sensor module such as a CCG or a HCG is present, all four of these relays are assigned to the module. If a dual sensor module such as a Pirani, CP, or Capacitance Manometer is used, 2 relays are assigned to each sensor connected to the module.

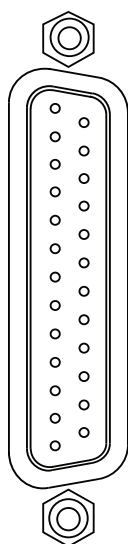

Pin	Description	Pin	Description
1	Relay 1 NO	14	Relay 7 NO
2	Relay 1 Common	15	Relay 7 Common
3	Relay 2 NO	16	Relay 8 NO
4	Relay 2 Common	17	Relay 8 Common
5	Relay 3 NO	18	Relay 9 NO
6	Relay 3 Common	19	Relay 9 Common
7	Relay 4 NO	20	Relay 10 NO
8	Relay 4 Common	21	Relay 10 Common
9	Relay 5 NO	22	Relay 11 NO
10	Relay 5 Common	23	Relay 11 Common
11	Relay 6 NO	24	Relay 12 NO
12	Relay 6 Common	25	Relay 12 Common
13	No Connection		

Table 8-1 Pin Out for the 946 Relay Output

## 8.1.2 Proper Setting of a Relay

Several parameters need to be correctly set to properly use the relays in a 946 Controller. Figure 8-1 shows that manner in which these parameters are defined.

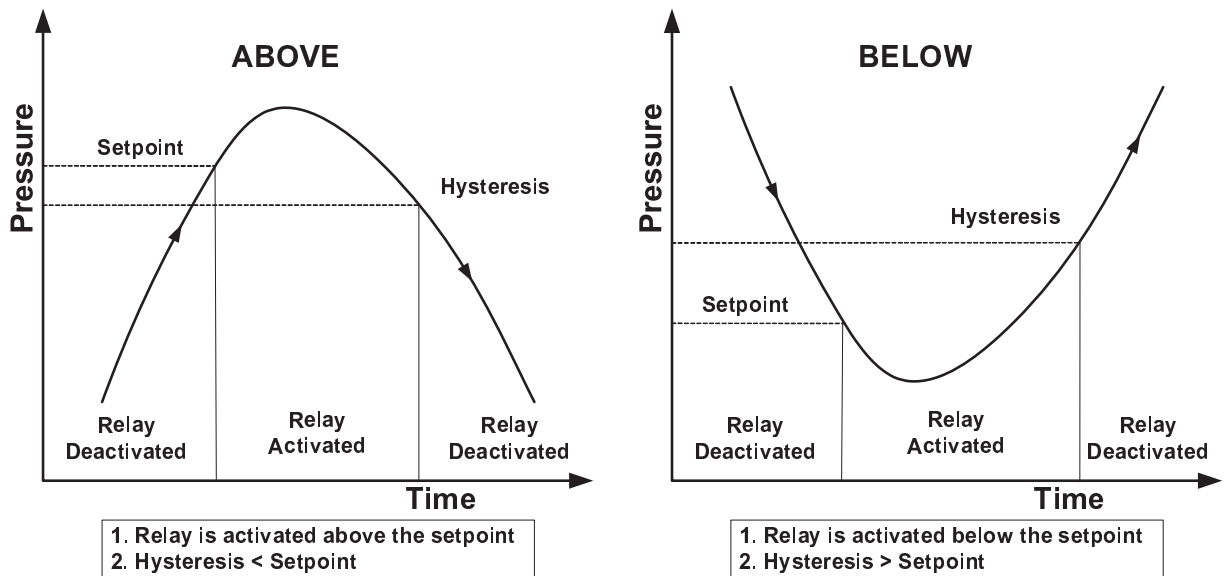

Figure 8-1 Definition of the Parameters used for Relay Control

### 1. Direction

Direction indicates the direction relative to the set point when the relay is activated. There are two choices: ABOVE and BELOW.

When ABOVE is selected, the relay will be activated when the system pressure is higher than the set point. All relays in the 946 are normally open so ABOVE must be selected to close a relay when the pressure rises above a defined value. For example, the 946 can be used to control a normally closed roughing by-pass valve in a vacuum system. If the pressure is above certain value (defined as the roughing pressure), a relay can be activated (i.e. closed) so that power is supplied to the solenoid of the NC roughing valve, opening the valve.

When BELOW is selected, the relay will be activated when the system pressure is lower than the set point. A typical application in this case is the control of a high vacuum chamber isolation valve. Using relay activation in the BELOW mode, a normally closed isolation valve can be opened only when the system pressure is below its set point.



**Since an ion gauge (either hot or cold cathode gauge) is turned off when the pressure is above its protection or control set point, only the BELOW direction is permitted for ion gauges. It is always dangerous to assume that the pressure is above a defined set point when the ion gauge is turned off.**

### 2. Hysteresis

Hysteresis is designed to prevent chattering of the relay. System pressure may fluctuate slightly, if the hysteresis is set too close to the set point value and there is a potential for undesired relay activation.

For example, when a main high vacuum isolation valve is opened, a small pressure rise may occur in the vacuum system. If the hysteresis is close to or identical with the pressure set point,



the controller will try to shut the valve. Such an operation is detrimental to system control and should be avoided. The hysteresis setting must therefore be higher than the set point.

Thus, when direction is set to ABOVE, the hysteresis must be lower than the set point, while when the direction is set to BELOW, the hysteresis must be higher than the set point.

When Direction is changed in the 946 Controller, a default offset value (about 10%) is given to the hysteresis to avoid above-mentioned problem. Depending on the application, this value may need to be optimized by the user.

### 8.1.3 Relay Inductive Loads and Arc Suppression

If the set point relay is used to switch inductive loads, e.g., solenoids, relays, transformers, etc., arcing of the relay contacts may interfere with the controller operation or reduce relay contact life. An arc suppression network, shown schematically in Figure 8-2, is therefore recommended.

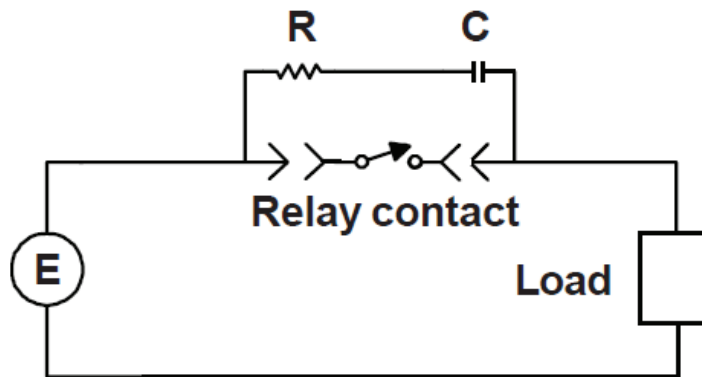

Figure 8-2 The Relay Arc Suppression Network

The values of the capacitance  $C$  and the resistance  $R$  are calculated using the equations:

$$C = \frac{I^2}{10} ; R = \frac{E}{10 \times I^a} \text{ and } a = 1 + \frac{50}{E}$$

where  $C$  is in  $\mu\text{F}$ ,  $R$  is in  $\Omega$ ,  $I$  is the DC or AC<sub>peak</sub> load current in amperes,  $E$  is the DC or AC<sub>peak</sub> source voltage in volts.  $C_{min} = 0.001\mu\text{F}$  and  $R_{min} = 0.5 \Omega$ .

## 8.2 Connecting the 946 Analog Output

Analog outputs are output via the 37-pin connector on the back of the AIO module. These analog signals can be used to for a variety of process control and other purposes. In particular, a combined logarithmic output capability allows two sensor outputs to be combined, providing the controller with a much wider pressure measurement range.

Analog output signals, which can be sent to a data acquisition system, are available for each sensor. These signals can be accessed from the 37 pin D-sub female connector on the back of the controller. They include buffered, logarithmic, and combination logarithmic output. Buffered and logarithmic analog outputs are simultaneously available from all sensors. The detailed assignment for these pins is described in Table 8-2.

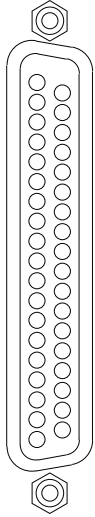

Pin	Description	Pin	Description
1	Buffered Aout A1	11	Log/Lin Aout C1
2	Buffered Aout A2	12	Log/Lin Aout C2
3	Buffered Aout B1	13	Combination Aout 1
4	Buffered Aout B2	14	Combination Aout 2
5	Buffered Aout C1	15	Power A1
6	Buffered Aout C2	16	Power A2/Degas A1
7	Log/Lin Aout A1	17	Power B1
8	Log/Lin Aout A2	18	Power B2/Degas B1
9	Log/Lin Aout B1	19	Power C1
10	Log/Lin Aout B2	20	Power C2/Degas C1
		21 to 37	Ground

**Table 8-2 Pin Out for 946 Analog Output**

### 8.3 Buffered Analog Output

A buffered analog signal responds immediately to sensor signal changes; it can therefore be used in critical fast controlling applications.



**Buffered analog signals are non-linear and strongly sensor dependent, use these signals with due caution.**

Normal buffered output for the 946 is 0 to 10 V. If a negative buffered voltage is observed, it may be caused by

- No discharge for a Cold Cathode, or a pressure reading of less than  $1 \times 10^{-11}$  Torr.
- A reading below zero for a Capacitance Manometer (zero adjustment may be required).

The buffered analog outputs for variety of pressure sensors in an unpowered state are shown in

Table 8-3.

Sensor	Buffered Analog Output when power is off
Cold Cathode (CC)	> 10 V
Hot Cathode (HC)	> 10V
Pirani (PR)	0
Convection Pirani (CP)	0

**Table 8-3 Buffered Analog Output when Sensor Power is Off.**

A Hot Cathode gauge uses different emission currents in different pressure ranges and therefore the analog output depends on the emission current and pressure. To avoid problems, logarithmic analog output is used as the buffered analog output.

Buffered analog output for the Cold Cathode, Hot Cathode, Pirani, Convection Pirani and Capacitance Manometers are shown in following figures and tables.

## Buffered Cold Cathode Analog Output (N<sub>2</sub>) (Series 421 and 423)

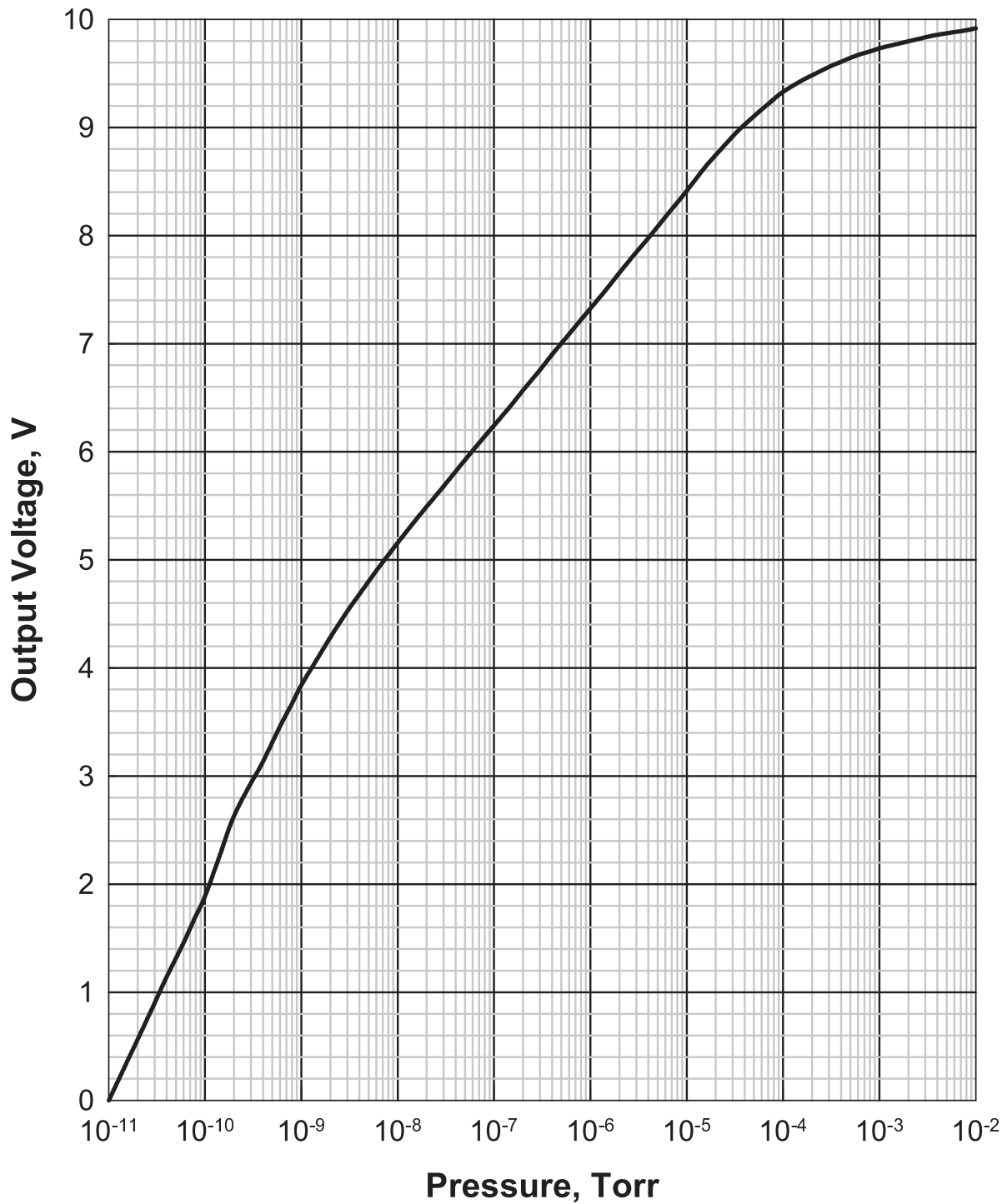

Figure 8-3 Buffered Analog Output for Cold Cathode Gauges (431/422/423) in N<sub>2</sub>

Pressure, Torr	Buffered Vout, V	Pressure, Torr	Buffered Vout, V
1.0E-11	0.0000	4.0E-07	6.8993
1.5E-11	0.3286	6.0E-07	7.0871
2.0E-11	0.5634	8.0E-07	7.2222
3.0E-11	0.8994	1.0E-06	7.3247
4.0E-11	1.1416	1.5E-06	7.5140
6.0E-11	1.4585	2.0E-06	7.6551
8.0E-11	1.7035	3.0E-06	7.8469
1.0E-10	1.8882	4.0E-06	7.9769
1.5E-10	2.3241	6.0E-06	8.1714
2.0E-10	2.6299	8.0E-06	8.3064
3.0E-10	2.9358	1.0E-05	8.4136
4.0E-10	3.1342	1.5E-05	8.6166
6.0E-10	3.4587	2.0E-05	8.7446
8.0E-10	3.6700	3.0E-05	8.9177
1.0E-09	3.8409	4.0E-05	9.0275
1.5E-09	4.1006	6.0E-05	9.1665
2.0E-09	4.2838	8.0E-05	9.2614
3.0E-09	4.5248	1.0E-04	9.3297
4.0E-09	4.6807	1.5E-04	9.4255
6.0E-09	4.8991	2.0E-04	9.4826
8.0E-09	5.0452	3.0E-04	9.5605
1.0E-08	5.1579	4.0E-04	9.6076
1.5E-08	5.3563	6.0E-04	9.6708
2.0E-08	5.4924	8.0E-04	9.7034
3.0E-08	5.6809	1.0E-03	9.7325
4.0E-08	5.8185	1.5E-03	9.7703
6.0E-08	6.0096	2.0E-03	9.7975
8.0E-08	6.1423	3.0E-03	9.8340
1.0E-07	6.2431	4.0E-03	9.8575
1.5E-07	6.4281	6.0E-03	9.8823
2.0E-07	6.5683	8.0E-03	9.8997
3.0E-07	6.7570	1.0E-02	9.9178

Table 8-4 Buffered Analog Output for the Cold Cathode Gauges (431/422/423) in N<sub>2</sub>. This is 2.4 Higher than the Raw Analog Output as shown in Table 8-5.

Range	Equation
V < 2.2V	$P = \exp(-25.3546 + 3.394V - 0.990V^2 + 0.4259V^3)$
2.2 V < V < 3.71 V	$P = \exp\left(\frac{V - 5.7722}{0.1969}\right)$
V > 3.71 V	$P = \exp\left(\frac{V - 4.2157}{0.3161 - 0.0721557V}\right)$

Table 8-5 Equations for Cold Cathode Gauges (N<sub>2</sub>) Raw Analog Output

## Buffered Hot Cathode Analog Output

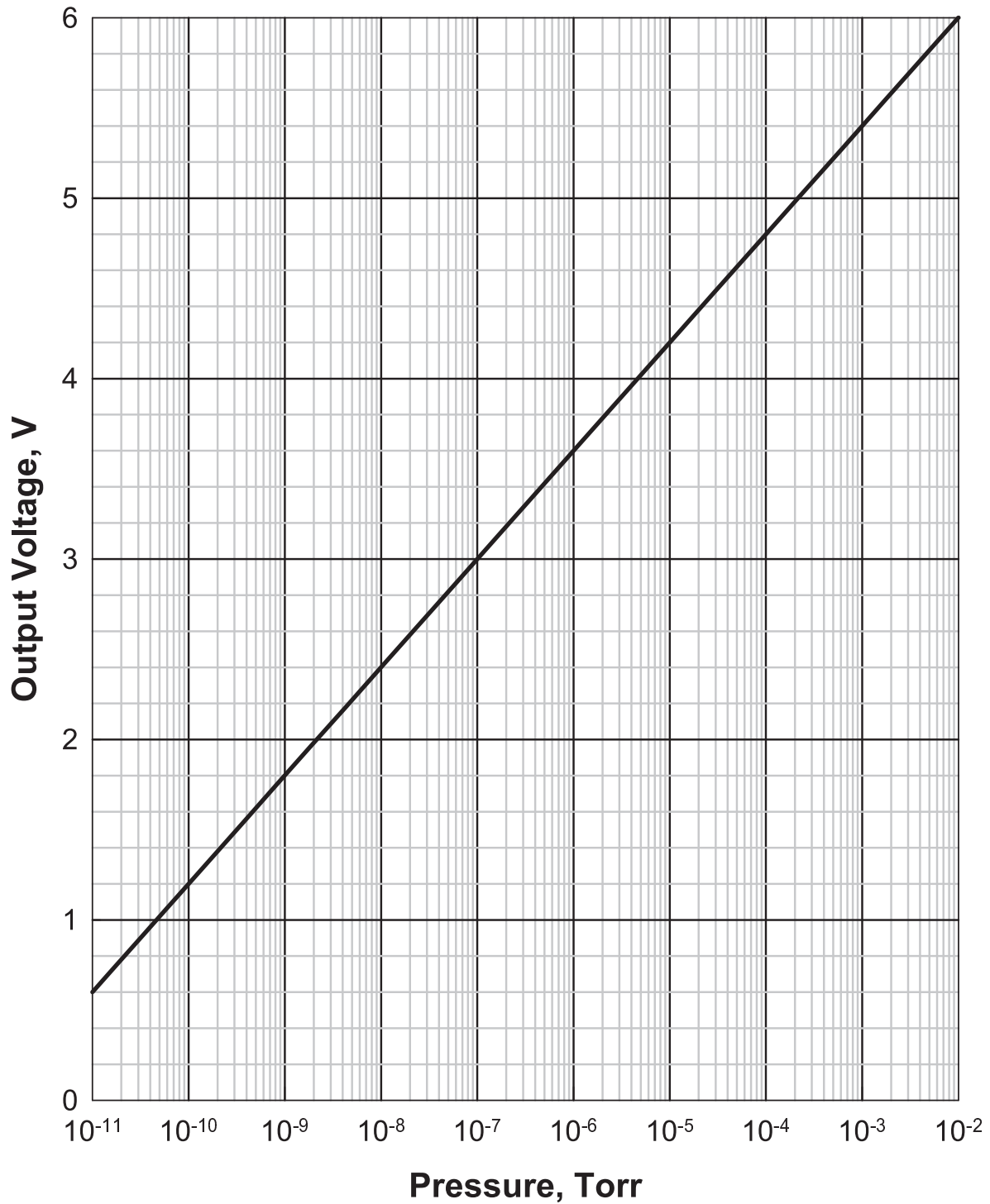

Figure 8-4 Buffered Analog Output for Hot Cathode Gauges; same as the Logarithmic Analog Output

## Buffered Pirani Analog Output (Series 315 & 345)

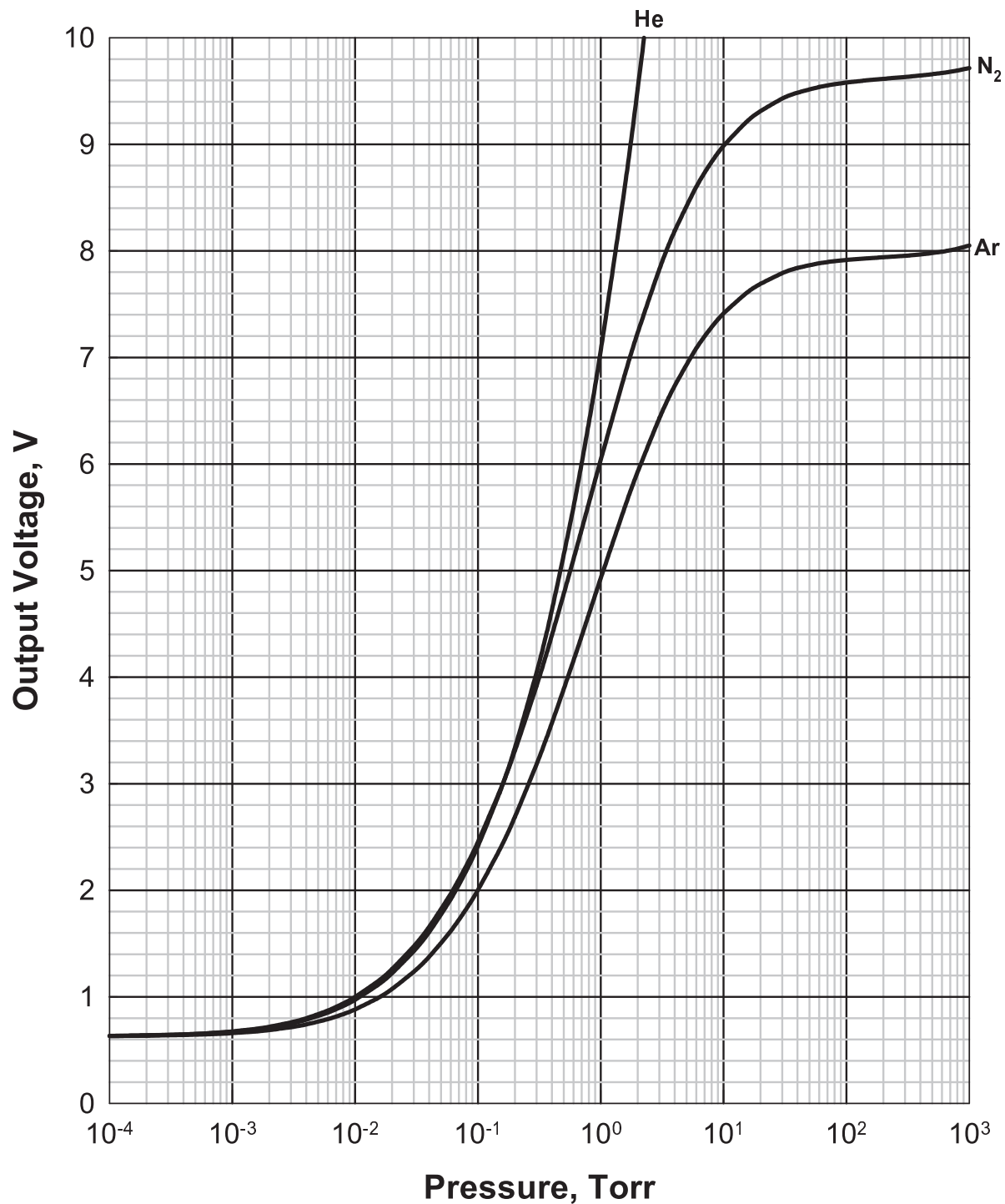

Figure 8-5 Buffered Analog Output for a 345 Pirani Gauge

Pressure, Torr	Buffered N <sub>2</sub> Vout, V	Buffered Ar Vout, V	Buffered He Vout, V
1.0E-04	0.6323	0.6324	0.6340
1.5E-04	0.6347	0.6339	0.6362
2.0E-04	0.6372	0.6355	0.6384
3.0E-04	0.6420	0.6385	0.6426
4.0E-04	0.6468	0.6414	0.6469
6.0E-04	0.6563	0.6474	0.6553
8.0E-04	0.6656	0.6533	0.6636
1.0E-03	0.6747	0.6591	0.6718
1.5E-03	0.6970	0.6734	0.6919
2.0E-03	0.7185	0.6875	0.7115
3.0E-03	0.7597	0.7147	0.7490
4.0E-03	0.7985	0.7408	0.7847
6.0E-03	0.8707	0.7905	0.8517
8.0E-03	0.9371	0.8371	0.9138
1.0E-02	0.9988	0.8812	0.9718
1.5E-02	1.1376	0.9824	1.1036
2.0E-02	1.2602	1.0735	1.2211
3.0E-02	1.4727	1.2344	1.4271
4.0E-02	1.6557	1.3751	1.6066
6.0E-02	1.9652	1.6162	1.9148
8.0E-02	2.2254	1.8213	2.1788
1.0E-01	2.4526	2.0015	2.4131
1.5E-01	2.9255	2.3794	2.9143
2.0E-01	3.3095	2.6885	3.3370
3.0E-01	3.9177	3.1815	4.0419
4.0E-01	4.3922	3.5686	4.6294
6.0E-01	5.1070	4.1556	5.5955
8.0E-01	5.6323	4.5898	6.3873
1.0E+00	6.0405	4.9289	7.0651
1.5E+00	6.7597	5.5295	8.4399
2.0E+00	7.2342	5.9282	9.5215
3.0E+00	7.8281	6.4295	11.1701
4.0E+00	8.1874	6.7340	
6.0E+00	8.6026	7.0869	
8.0E+00	8.8363	7.2858	
1.0E+01	8.9862	7.4136	
1.5E+01	9.1992	7.5950	
2.0E+01	9.3119	7.6909	
3.0E+01	9.4294	7.7908	
4.0E+01	9.4846	7.8398	
6.0E+01	9.5377	7.8835	
8.0E+01	9.5638	7.9034	
1.0E+02	9.5795	7.9149	
1.5E+02	9.6017	7.9306	
2.0E+02	9.6146	7.9400	
3.0E+02	9.6319	7.9539	
4.0E+02	9.6454	7.9664	
6.0E+02	9.6693	7.9922	
8.0E+02	9.6925	8.0200	
1.0E+03	9.7157	8.0502	

Table 8-6 Buffered Analog Output for the 315/345 Pirani Sensors

Range	Equation
<b>Nitrogen</b>	
$0.63 < V < 9.3 \text{ V}$ $1 \times 10^{-4} < p < 20 \text{ torr}$	$p = \left( \frac{1.585}{\frac{93.303}{V^2 - 0.3935} - 1} \right)^{1.007}$
$9.3 \text{ V} < V < 9.72 \text{ V}$ $20 < p < 1 \times 10^3 \text{ torr}$	$p = 4123 \times \left[ (V - 9.621) + \sqrt{(V - 9.621)^2 + 1.34 \times 10^{-3}} \right]^{0.8696}$
<b>Argon</b>	
$0.63 < V < 7.79 \text{ V}$ $1 \times 10^{-4} < p < 20 \text{ torr}$	$p = \frac{1.663}{\frac{63.63}{V^2 - 0.3961} - 1}$
$7.79 \text{ V} < V < 8.05 \text{ V}$ $30 < p < 1 \times 10^3 \text{ torr}$	$p = 2959 \times \left[ (V - 7.9386) + \sqrt{(V - 7.9386)^2 + 5.464 \times 10^{-4}} \right]^{0.729}$
<b>Helium</b>	
$0.63 < V < 10 \text{ V}$ $1 \times 10^{-4} < 3 \text{ torr}$	$p = \frac{9.287}{\frac{509.4}{V^2 - 0.3965} - 1}$

Table 8-7 Equations for the 345 Pirani Sensors



# Buffered Convection Pirani Analog Output (Series 317)

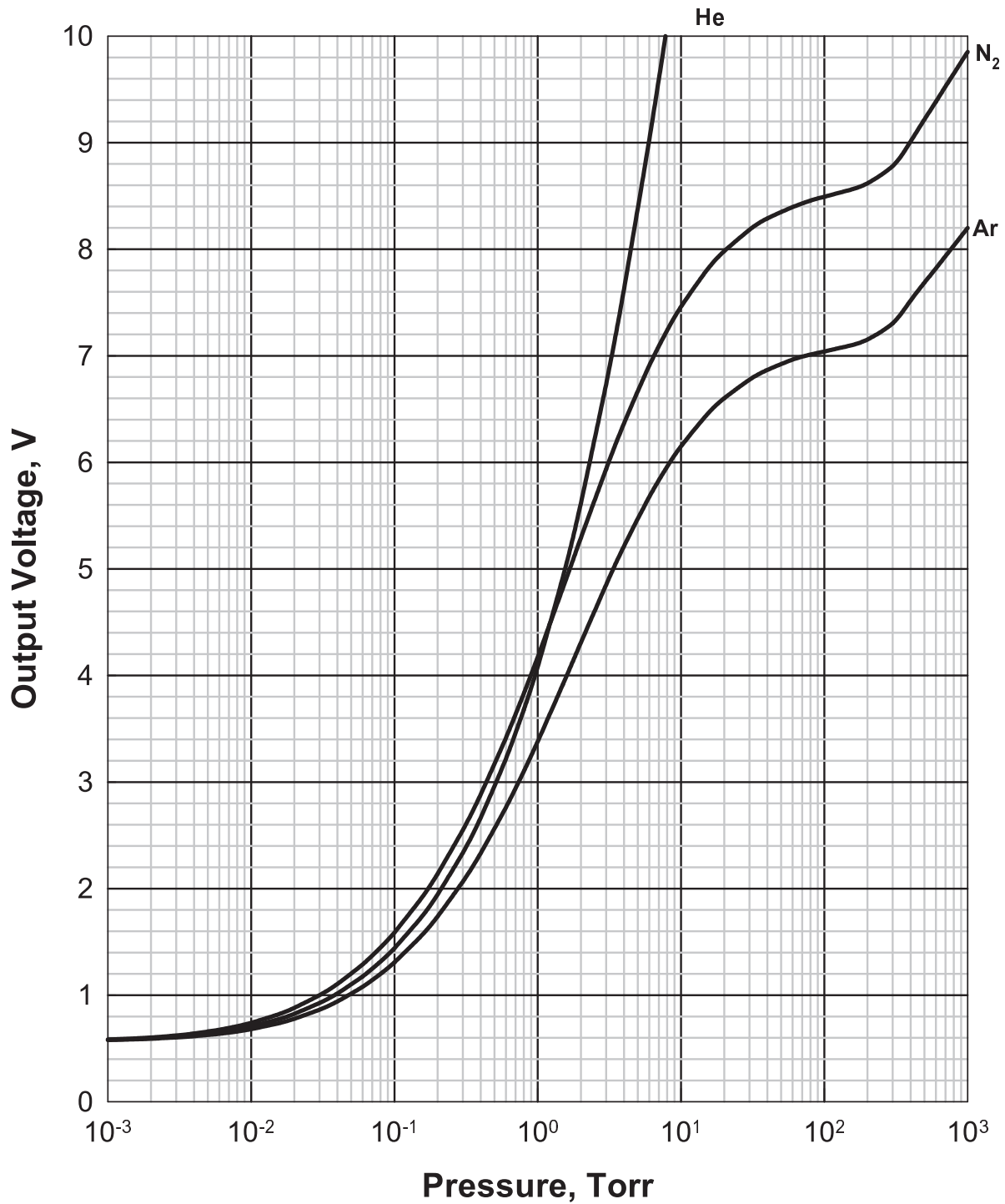

Figure 8-6 Buffered Analog Output for the 317 Convection Pirani Gauge

Pressure, Torr	Buffered N <sub>2</sub> Vout, V	Buffered Ar Vout, V	Buffered He Vout, V
1.0E-04	0.5639	0.5674	0.5654
1.5E-04	0.5650	0.5680	0.5663
2.0E-04	0.5660	0.5687	0.5671
3.0E-04	0.5681	0.5699	0.5688
4.0E-04	0.5702	0.5712	0.5705
6.0E-04	0.5744	0.5737	0.5738
8.0E-04	0.5785	0.5762	0.5771
1.0E-03	0.5825	0.5787	0.5803
1.5E-03	0.5925	0.5849	0.5883
2.0E-03	0.6023	0.5909	0.5961
3.0E-03	0.6213	0.6029	0.6114
4.0E-03	0.6397	0.6147	0.6262
6.0E-03	0.6748	0.6375	0.6547
8.0E-03	0.7081	0.6594	0.6818
1.0E-02	0.7397	0.6807	0.7077
1.5E-02	0.8130	0.7309	0.7685
2.0E-02	0.8799	0.7778	0.8244
3.0E-02	0.9993	0.8635	0.9256
4.0E-02	1.1050	0.9410	1.0161
6.0E-02	1.2884	1.0782	1.1755
8.0E-02	1.4465	1.1985	1.3147
1.0E-01	1.5870	1.3066	1.4398
1.5E-01	1.8866	1.5399	1.7110
2.0E-01	2.1371	1.7370	1.9427
3.0E-01	2.5480	2.0637	2.3341
4.0E-01	2.8825	2.3318	2.6645
6.0E-01	3.4139	2.7612	3.2168
8.0E-01	3.8301	3.1003	3.6784
1.0E+00	4.1716	3.3801	4.0811
1.5E+00	4.8207	3.9161	4.9231
2.0E+00	5.2897	4.3067	5.6142
3.0E+00	5.9352	4.8489	6.7300
4.0E+00	6.3647	5.2126	7.6243
6.0E+00	6.9069	5.6749	9.0227
8.0E+00	7.2375	5.9585	10.0998
1.0E+01	7.4611	6.1510	10.9720
1.5E+01	7.7955	6.4399	
2.0E+01	7.9814	6.6008	
3.0E+01	8.1820	6.7747	
4.0E+01	8.2885	6.8671	
6.0E+01	8.3954	6.9637	
8.0E+01	8.4563	7.0109	
1.0E+02	8.4917	7.0396	
1.5E+02	8.5547	7.0943	
2.0E+02	8.6178	7.1523	
3.0E+02	8.7804	7.3037	
4.0E+02	9.0106	7.5176	
6.0E+02	9.3827	7.8191	
8.0E+02	9.6467	8.0330	
1.0E+03	9.8515	8.1989	

**Table 8-8 Buffered Analog Output for the 317 Convection Pirani Sensor**

Range	Equation
<b>Nitrogen</b>	
$0.56 < V < 8.3 \text{ V}$ $1 \times 10^{-4} < p < 40$ torr	$p = \left( \frac{3.35}{\frac{74.327}{V^2 - 0.3156} - 1} \right)^{1.01}$
$8.3 \text{ V} < V < 8.8 \text{ V}$ $40 < p < 300 \text{ torr}$	$p = 399.5 \sqrt{(V - 8.503) + \sqrt{(V - 8.503)^2 + 5.372 \times 10^{-3}}}$
$p > 300 \text{ torr}$	$p = \exp\left(\frac{V - 3.512}{0.9177}\right)$
<b>Argon</b>	
$0.56 < V < 7.00 \text{ V}$ $1 \times 10^{-4} < p < 60$ torr	$p = \left( \frac{3.6}{\frac{51.083}{V^2 - 0.3205} - 1} \right)^{1.002}$
$7.00 \text{ V} < V < 7.4 \text{ V}$ $60 < p < 300 \text{ torr}$	$p = 411.2 \sqrt{(V - 7.042) + \sqrt{(V - 7.042)^2 + 3.789 \times 10^{-3}}}$
$P > 300 \text{ torr}$	$p = \exp\left(\frac{V - 3.063}{0.7436}\right)$
<b>Helium</b>	
$0.63 < V < 10 \text{ V}$ $1 \times 10^{-4} < p < 4$ torr	$p = \left( \frac{26.93}{\frac{456.3}{V^2 - 0.3177} - 1} \right)^{1.017}$

Table 8-9 Equations for the 317 Convection Pirani Sensor

# Buffered Capacitance Manometer Analog Output

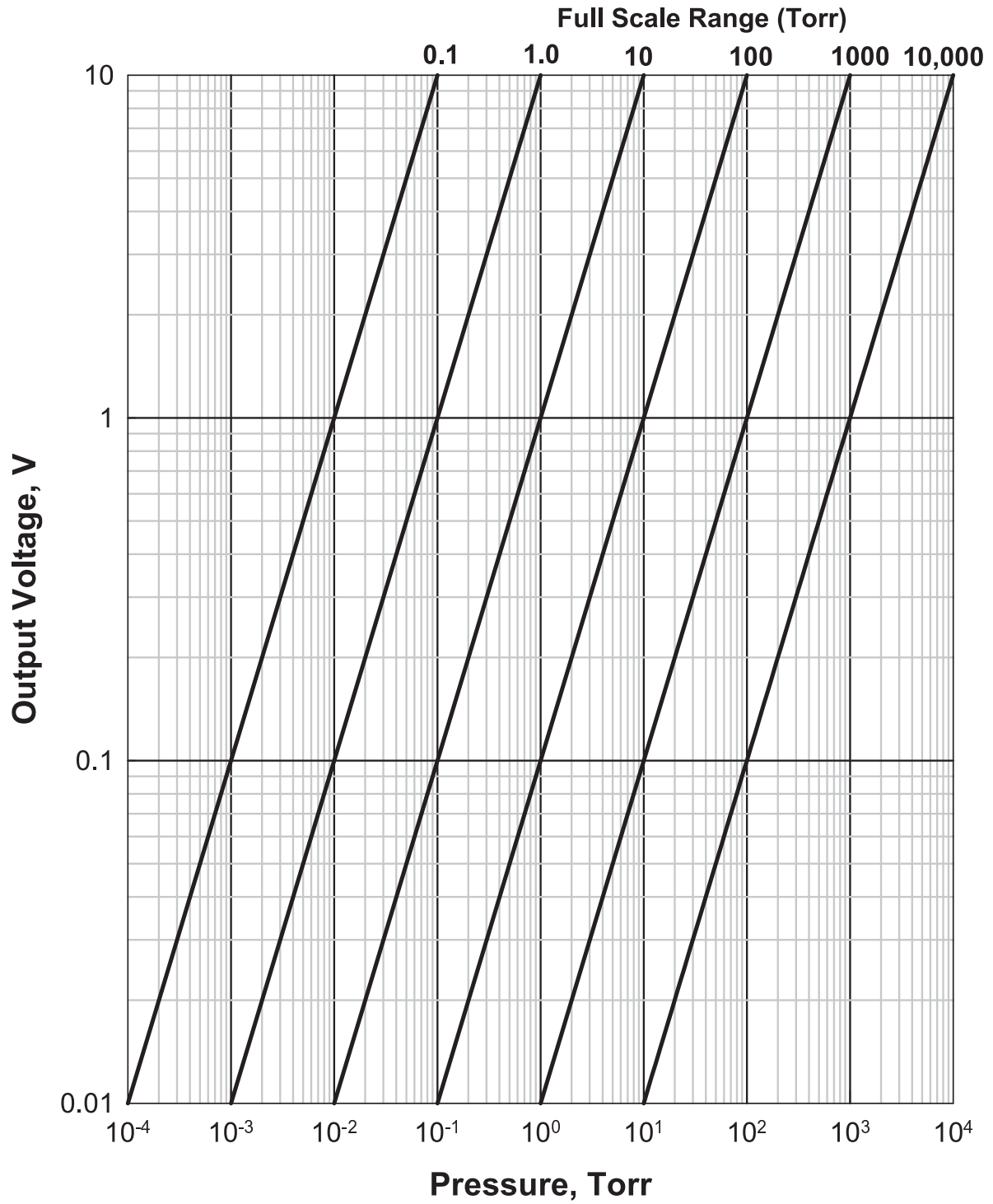

Figure 8-7 Buffered Analog Output for Capacitance Manometers

## 8.4 Logarithmic/Linear and Combination Analog Output

Since most of the buffered analog outputs are non-linear, logarithmically linearized or linear analog outputs are also provided for each individual sensor. However, since the logarithmic/linear analog outputs are processed by the microprocessor, these are updated every 50 msec, regardless of the number of sensors being connected to the controller.

In addition to these Log/Lin analog outputs, 2 combination analog outputs are also available. Up to 3 sensors can be selected for a combination analog output.

### 8.4.1 Logarithmic/Linear Analog Output

There are two types of analog output that can be selected for each channel: logarithmic

( $V = A \bullet \log(p) + B$ ) or linear ( $V = A \bullet p$ ). Since these analog outputs are determined by the DACs inside the controller, they can be modified by setting appropriate DAC parameters in the System Setup screen shown in Figure 6-6.

The default analog output for the 946 controller is logarithmic having a slope of 0.6V per decade and an offset of 7.2 V ( $V = 0.6 \text{Log}(p) + 7.2$ ). This covers analog output ranging from 0.6 to 9.6 V (equivalent to a pressure range from  $1 \times 10^{-11}$  to  $1 \times 10^4$  Torr).

For detailed setting of the DAC parameters, refer to System Setup, Section 6.4.

### 8.4.2 Combination Analog Output

In addition to the logarithmic analog output for each individual sensor, two combination analog outputs are available. This allows for wider pressure range coverage since a combination output combines the measurement ranges of multiple gauges.

When Capacitance Manometers are used in combination, no smoothing is provided in the overlap range. The 95% rule is used in switching the Capacitance Manometers. That is, if the reported pressure on the lower range Manometer is greater than 95% of its full scale, the combined analog output will be switched to the upper range Manometer. In other words, the lower range Capacitance Manometer is used as master in gauge switching.



When a Capacitance Manometer and a Pirani/Convection Pirani are used in combination, if the Pirani/Convection Pirani reading is greater than 5% of the full scale of the Capacitance Manometer (must be >500 Torr full scale), the combined analog output will switch to the Capacitance Manometer.

When a Capacitance Manometer and an Ion gauge are used in combination, the Ion gauge pressure will be used as the combined analog output. The combined output will switch to the Capacitance Manometer only when the Ion gauge is turned off.

If a Pirani/Convection Pirani and an Ion gauges are use in combination, a smoothing formula is used for the combined analog output where sensor ranges overlap ( $10^{-3}$  to  $10^{-4}$  torr).

Whenever combination is disabled and power is on then combination output is 10V.

Whenever three gauges are used in combination, if a fault is detected with any gauge, then the combination output is 10V. Possible faults are: gauge of at rear panel, filament failure, or cable disconnected.

To set the combination analog output from the from panel, press the  button, then move the cursor to change the Set Combination Ch parameter to On. After pressing , a setup screen will appear, as shown below:

Set Combination Channel Parameter				
	High	Middle	Low	Enable
Combo #1	C2	B1	A1	Enable
Combo #2	NA	NA	NA	Disable

**Figure 8-8 Setup Screen for Setting Combination Channel Parameters**

Once the combination gauges have been properly selected, enable the combined analog output. If invalid gauge channels are selected, the Enable parameter will stay in the Disabled mode.

The following rules may be used to simplify the gauge combination configuration.

- The combination must include at least two pressure gauges.
- NA is used as the parameter when no gauge is assigned
- If an Ion gauge (either Cold Cathode or Hot Cathode) is included in the combination, it must be assigned as the low pressure range gauge (“Low” in Figure 8.8).
- If a Pirani or Convection Pirani gauge is included in the combination, it must be assigned as the middle pressure range gauge (“Middle” in Figure 8.8).
- When a Pirani or Convection Pirani is used in combination, only an Ion gauge is allowed to be assigned as the low pressure range gauge.
- Capacitance Manometers cannot be differential type.
- Only Capacitance Manometer is allowed to be assigned as the high pressure range gauge.
- If a Capacitance Manometer is the High range and a Pirani is the Middle range, then the Capacitance Manometer full scale range has to be >500 torr.
- If two or more Capacitance Manometers are used in a combination then high range >= middle range >= low range.
- When multiple Capacitance Manometers with same full scale ranges are set to combination, the output are the average of these gauge outputs.
- Only logarithmic analog output is available for combined analog output.



**Pay special attention to the selection of the controlling gauge for the Ion gauge; make sure that both gauges are connected to the same vacuum space at all times, (make sure no valve is present between these gauges). If a valve between these two gauges is closed, or if these gauges are connected to different vacuum chambers, it may lead not only to bad combined pressure readings – it can also destroy an Ion gauge sensor.**

Combination pressure settings can also be accomplished using following serial commands:

- Query the pressure

@254PC1?;FF for corresponding pressure on combined Aout 1 and @254PC2?;FF for the pressure on combined Aout 2.

- Set the gauge combination

@254SPC1!HH,MM,LL;FF and @254SPC2!HH,MM,LL;FF . Here, **HH**, **MM** and **LL** are the gauge channel (**A1**, **A2**, **B1**, **B2**, **C1**, **C2**, **NA**) corresponding to the gauge assigned to High, Middle, and Low range pressure gauges.

- Query the gauge combination

@254SPC1?;FF and @254SPC2?;FF .

- Enable/disable the combined analog output

@254EPC1!Enable;FF and @254EPC1!Disable;FF .

### 8.4.3 Logarithmic/Linear Analog Output when the Gauge Power is Turned Off

There is time when the power to a pressure gauge (especially an ion gauge) will be turned off during the operation. The following table shows the expected logarithmic/linear analog output when the gauge power is turned off or the combined analog output is disabled.

	Analog Out (Volts)	Linear Out (volts)	Log-Linear Out (Volts)
946 Power off	0	0	0
Pirani type gauge channel off or gauge off via RP	0	10	10
Pirani type below range	See Analog Out Chart for Gauge	0	0.2
Pirani type filament failed	0	10	10
Pirani type cable disconnected	0	>10	>10
CC off from front panel; rear panel; via a 'control gauge'; or 'protect'	11.5	10.5	10.5
HC off from front panel; rear panel; via 'control gauge'; 'protect'; disconnected cable; or failed filament	10	10	10
CM (Absolute) below range	0	0	0.2
CM (Absolute) disconnected cable	-11	0	0.2
CM above range	11	10	9.8
CM (Differential) disconnected cable or below range	-11	0	0
CM (Differential) above range	11	0	0

Table 8-10 The Expected Logarithmic/Linear Analog Output Values

# 946 RS232/485 Serial Communication Commands

## 8.5 Serial Communication Wiring Diagram

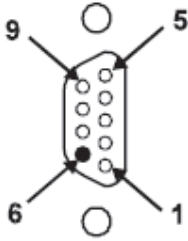

Pin	Description
2	RS485(-)/RS232TxD/(B)
3	RS485(+)/RS232RxD/(A)
5	Ground

Table 8-11 946 Serial Communication Wiring Diagram

## 8.6 Communication Protocols

Cable length with RS232 signals	50 ft (15 m)
Cable length with RS485 signals	4000 ft (1200 m)
Baud rate	9600, 19200, 38400, 57600, 115200
Character format	8 data bits, 1 stop bit, No parity, No hardware handshaking
Query format	<p><b>@&lt;aaa&gt;&lt;Command&gt;?;FF</b>            The corresponding response is  <b>@&lt;aaa&gt;ACK&lt;Response&gt;;FF</b>            Here, &lt;aaa&gt;: Address, 1 to 254            &lt;Command&gt;: Commands as described in 9.7 to9.18            &lt;Response&gt; Responses as described in 9.7 to9.18            For example, to query pressure on channel A1, use  <b>@003PR1?;FF</b>            and the corresponding response is  <b>@003ACK7.602E+2;FF</b>            Here, &lt;aaa&gt;=003; &lt;Command&gt;=PR1; &lt;Response&gt;=7.602E+2</p>
Set format	<p><b>@&lt;aaa&gt;&lt;Command&gt;!&lt;parameter&gt;;FF</b>            The corresponding response is  <b>@&lt;aaa&gt;ACK&lt;Response&gt;;FF</b>            Here, &lt;aaa&gt;: address, 1 to 254            &lt;Command&gt; Commands as described in 9.7 to9.18            &lt;Parameter&gt; Parameter as described in 9.7 to9.18            &lt;Response&gt; Responses as described in 9.7 to9.18            For example, to set new baud rate, use  <b>@001BR!19200;FF</b>            and the corresponding response is  <b>@001ACK19200;FF</b>            Here, &lt;aaa&gt;=001; &lt;Command&gt;=BR; &lt;Parameter&gt;=19200;            &lt;Response&gt;=19200</p>

Table 8-12 946 Serial Communication Command Protocol



## 8.7 Pressure Reading Commands

Command	Function	Response	Meaning			
<b>Single Channels</b>						
<b>PRn</b> (n=1 to 6)	Read pressure on Channel n	<b>d.d0E±ee</b> (d,e=0 to 9)	Pressure in selected units for PR, CP, CC & HC			
		<b>d.dddE±e</b> (d,e =0 to 9)	Pressure in selected units for CM			
		<b>-d.ddE±e</b> (d,e=0 to 9)	CM, when CM output is negative.			
		<b>LO&lt;E-e</b>	Gauge	e(torr/mbar)	e(Pascal)	e(micron)
			PR	4	2	1
			CP	3	1	0
			CC	11	9	8
		HC	10	8	7	
		<b>ATM</b>	PR when p>450 Torr			
		<b>OFF</b>	Cold cathode HV is off, or HC/PR/CP power is off.			
		<b>RP_OFF</b>	HC and CC power is turned off from rear panel control			
		<b>WAIT</b>	CC or HC startup delay			
		<b>LowEmis</b>	HC off due to low emission			
<b>CTRL_OFF</b>	CC or HC is off in controlled state					
<b>PROT_OFF</b>	CC or HC is off in protected state					
<b>MISCONN</b>	Sensor improperly connected, or broken filament (PR, CP only)					
<b>NO_GAUGE</b>	Controller unable to determine gauge connection.					
<b>PRZ</b>	Read pressures on all channel	6 of above, separated by spaces	Same as above			
<b>Combination Channels</b>						
<b>PCn</b> (n=1 or 2)	Read pressure on channel n and its combination sensor	<b>d.d0E±ee</b> (d,e=0 to 9)	Combined pressure in selected units			
		<b>NAK181</b>	Combination disabled			

Table 8-13 946 Pressure Reading Commands

## 8.8 Relay and Control Setting Commands

Command	Parameter	Response	Function
<b>SPm</b> (m=1 to 12)	<b>d.dd E±ee</b> (d,e=0 to 9)	<b>d.dd E±ee</b> (d,e=0 to 9)	Query or set a set point for relay m, response with the current setting value. If 0 is used as the parameter, the set point will be set as its low limit value.
<b>SHm</b> (m=1 to 12)	<b>d.dd E±ee</b> (d,e=0 to 9)	<b>d.dd E±ee</b> (d,e=0 to 9)	Query or set a hysteresis for relay m, response with the current setting value.
<b>SDm</b> (m=1 to 12)	<b>ABOVE</b> or <b>BELOW</b>	<b>ABOVE</b> or <b>BELOW</b>	Query or set the direction for relay m, response with the current setting value. For CC and HC, only BELOW can be selected.
		<b>NAK162</b>	For CC and HC as the relay direction is fixed to BELOW.
<b>ENm</b> (m=1 to 12)	<b>SET,</b> <b>ENABLE,</b> or <b>CLEAR</b>	<b>SET,</b> <b>ENABLE,</b> or <b>CLEAR</b>	Query or set status for relay m. Response with current Enable status. <b>ENABLE</b> enables the relay, its status depends on the pressure and set point value, <b>SET</b> forces relay activation, regardless of pressure, and <b>CLEAR</b> disable relay.
<b>SSm</b> (m=1 to 12)		<b>SET</b> or <b>CLEAR</b>	Query all the relay setting status, <b>SET</b> is activated, and <b>CLEAR</b> is disabled.
<b>ENA</b>		<b>ddd..ddd</b> (d=0,1,2)	Query single relay set point status (relay1 relay 2 ...relay 12). 0: clear; 1: set; 2: enable.
<b>SSA</b>		<b>ddd..ddd</b> (d=0,1)	Query all 12 relay set point status (relay1 relay 2 ...relay 12). 0: clear; 1: set.

Table 8-14 946 Relay and Control Serial Setting Commands

## 8.9 Capacitance Manometer Control Commands

Command	Parameter	Response	Function
<b>RGn</b> (n=1 to 6)	<b>d.dd E±ee</b>	<b>d.dd E±ee</b>	Query or set the full scale pressure measurement range for a capacitance manometer. Valid range is from 0.01 to 50000, and default range is 1000 Torr.
<b>CMTn</b> (n=1 to 6)	<b>ABS or Diff</b>	<b>ABS or Diff</b>	Query or set the Capacitor Manometer type, either absolute or differential.
<b>BVRn</b> (n=1 to 6)	<b>5 or 10</b> for ABS <b>1B, 5B, 1U, 5U or 10U</b> for Diff	<b>5 or 10</b> for ABS <b>1B, 5B, 1U, 5U or 10U</b> for Diff	Query or set the full scale voltage output range for a capacitance manometer. Default = 10V.
<b>ATZn</b> (n=1 to 6)		<b>OK or NAK</b>	Zero a differential Capacitance Manometer on channel n.
<b>VACn</b> (n=1 to 6)		<b>OK or NAK</b>	Zero a capacitance manometer on channel n. Execute only when the signal is less than 5% of the full scale.
<b>AZn</b> (n=1 to 6)	<b>A1, B1, A2, B2, C1, C2, NA</b>	<b>A1, B1, A2, B2, C1, C2, NA</b>	Query or set capacitance manometer autozero control channel n, or disable autozero (NA). Execute only when the signal is less than 5% of the full scale.

Table 8-15 946 Capacitance Manometer Serial Commands

## 8.10 Pirani and Convection Pirani Control Commands

Command	Parameter	Response	Function
<b>ATMn</b> (n=1 to 6)	<b>d.ddE+ee</b> (ambient pressure)	<b>d.ddE+ee</b>	Send an atmospheric pressure to perform ATM calibration. The PR/CP must be at atmospheric pressure when running ATM calibration. Valid range is from 100 to 1000.
<b>VACn</b> (n=1 to 6)		<b>OK or NAK</b>	Zero a PR/CP on channel n. Execute only when the pressure reading is less than $1 \times 10^{-2}$ Torr.
<b>AZn</b> (n=1 to 6)	<b>A1, B1, A2, B2, C1, C2, NA</b>	<b>A1, B1, A2, B2, C1, C2, NA</b>	Query or set an autozero (CC or HC) control channel n for a PR/CP, or disable autozero (NA). Execute only when the pressure reading is less than $1 \times 10^{-2}$ Torr.
<b>GTn</b> (n=1 to 6)	<b>Nitrogen Argon Helium</b>	<b>Nitrogen Argon Helium</b>	Query or set a gas type for PR/CP on channel n.
<b>CPn</b> (n=1 to 6)	<b>ON or OFF</b>	<b>ON or OFF</b>	Query the channel power status for PR, CP, HC or high voltage status for CC. Turn on/off the channel power for PR, CP, HC, or high voltage for CC).
<b>PTn</b> (n=1 to 6)	<b>AUTO PR CP</b>	<b>AUTO PR CP AUTO-PR AUTO-CP</b>	Query or set Pirani gauge type on channel n. If Pirani type is set to PR or CP, the PTn command will respond PR or CP. If the Pirani is set to AUTO, the PTn command will response with the Pirani type it auto detects, i.e. AUTO-PR, when it detects the PR.

Table 8-16 946 Pirani and Convection Pirani Control Commands

## 8.11 Cold Cathode Control Commands

Command	Parameter	Response	Function
<b>PROn</b> (n=1, 3, 5)	<b>d.dd E±ee</b> (d,e=0 to 9)	<b>d.dd E±ee</b> (d,e=0 to 9)	Query or set protection set point value for ion gauge for channel n. The valid PRO range is $1 \times 10^{-5}$ to $1 \times 10^{-2}$ Torr. Use 0.0 to disable the protect set point control. Default value is $5 \times 10^{-3}$ Torr.
<b>CSPn</b> (n=1, 3, 5)	<b>d.dd E±ee</b> (d,e=0 to 9)	<b>d.dd E±ee</b> (d,e=0 to 9)	Query and set control set point value for an ion gauge on channel n. Valid CSP range is $5 \times 10^{-4}$ to $1 \times 10^{-2}$ Torr for Pirani, $2 \times 10^{-3}$ to $1 \times 10^{-2}$ Torr for convention Pirani, and 0.2% of Full scale to 0.02 Torr for Capacitance Manometer. Capacitance Manometer full scale range has to be $\leq 2$ Torr. Control channel (CSE command) needs to be set to a valid channel prior to setting this command.
<b>XCSn</b> (n=1, 3, 5)	<b>ON or OFF</b>	<b>ON or OFF</b>	Query or set the upper control set point status. If "ON" the range extended from $1 \times 10^{-2}$ Torr to $9.5 \times 10^{-1}$ Torr.
<b>CHPn</b> (n=1, 3, 5)	<b>d.dd E±ee</b> (d,e=0 to 9)	<b>d.dd E±ee</b> (d,e=0 to 9)	Query and set control set point hysteresis value for an ion gauge on channel n. Valid CHP range is $1.2 \times \text{CSP}$ to $1.1 \times 10^{-2}$ Torr for Convention Pirani and Pirani, and $1.2 \times \text{CSP}$ to 0.03 Torr for Capacitance Manometer. Default value is 1.5X the control set point value.
<b>CSEn</b> (n=1, 3, 5)	<b>A1, B1, A2, B2, C1, C2, OFF</b>	<b>A1, B1, A2, B2, C1, C2, OFF</b>	Query, enable/disable the control channel status for an ion gauge on channel n.
<b>CTLn</b> (n=1, 3, 5)	<b>AUTO, SAFE, OFF</b>	<b>AUTO, SAFE, OFF</b>	AUTO: Ion gauge can be turned on & off by the controlling gauge. SAFE, ion gauge can be turned off, but, not be turned on by the controlling gauge.
<b>UCn</b> (n=1,3, 5)	<b>dd.d</b> (d=0 to 9)	<b>dd.d</b> (d=0 to 9)	Query or set a gas correction factor for a CC gauge on Channel n. Valid range is from 0.1 to 10.
<b>CPn</b> (n=1,3, 5)	<b>ON or OFF</b>	<b>ON or OFF</b>	Query the channel power status for PR, CP, HC or high voltage status for CC. Turn on/off the channel power for PR, CP, HC, or high voltage for CC).
<b>GTn</b> (n=1,3, 5)	<b>Nitrogen Argon Helium</b>	<b>Nitrogen Argon Helium</b>	Query or set a gas type for HC/CC on channel n.
<b>Tn</b> (n=1,3, 5)		<b>W, O, G, P, C, R, H, L</b>	Ion gauge status query. W = WAIT O = OFF G = GOOD C = Control P = PROTECT R = Rear panel Ctrl off H = High L = LOW
<b>TDCn</b> (n=1,3, 5)	<b>d</b> (d=0 to 9)	<b>d</b> (d=0 to 9)	Time delay for starting CCG, 3 to 300 secs
<b>FRCn</b> (n=1,3,5)	<b>d.d E±ee</b> (d,e=0 to 9)	<b>d.d E±ee</b> (d,e=0 to 9)	Query or set the pressure to trigger fast relay control output. Only available for special CC board with fast relay, and the set point value needs to be between $5 \times 10^{-5}$ to $2 \times 10^{-10}$ Torr.

Table 8-17 946 Cold and Hot Cathode Control Commands

## 8.12 Hot Cathode Control Commands

Command	Parameter	Response	Function
<b>PROn</b> (n=1, 3, 5)	<b>d.dd E±ee</b> (d,e=0 to 9)	<b>d.dd E±ee</b> (d,e=0 to 9) <b>DISABLE</b>	Query or set protection set point value for Ion gauge for channel n. The valid PRO range is $1 \times 10^{-5}$ to $1 \times 10^{-2}$ Torr. Use 0.0 to disable the protect set point control. Default value is $5 \times 10^{-3}$ Torr.
<b>CSPn</b> (n=1, 3, 5)	<b>d.dd E±ee</b> (d,e=0 to 9)	<b>d.dd E±ee</b> (d,e=0 to 9)	Query and set control set point value for an Ion gauge on channel n. Valid CSP range is $5 \times 10^{-4}$ to $1 \times 10^{-2}$ Torr for Pirani, $2 \times 10^{-3}$ to $1 \times 10^{-2}$ Torr for Convention Pirani, and 0.2% of Full scale to 0.02 Torr for Capacitance Manometer. Capacitance Manometer full scale range has to be $\leq 2$ Torr. Control channel (CSE command) needs to be set to a valid channel prior to setting this command.
<b>XCSn</b> (n=1, 3, 5)	<b>ON or OFF</b>	<b>ON or OFF</b>	Query or set the upper control set point status. If "ON" the range extended from $1 \times 10^{-2}$ Torr to $9.5 \times 10^{-1}$ Torr.
<b>CHPn</b> (n=1, 3, 5)	<b>d.dd E±ee</b> (d,e=0 to 9)	<b>d.dd E±ee</b> (d,e=0 to 9)	Query and set control set point hysteresis value for an Ion gauge on channel n. Valid CHP range is $1.2 \times \text{CSP}$ to $1.1 \times 10^{-2}$ Torr for Convention Pirani and Pirani, and $1.2 \times \text{CSP}$ to 0.03 torr for Capacitance Manometer. Default value is 1.5X the control set point value.
<b>CSEn</b> (n=1, 3, 5)	<b>A1, B1, A2, B2, C1, C2, OFF</b>	<b>A1, B1, A2, B2, C1, C2, OFF</b>	Query, enable/disable the control channel status for an Ion gauge on channel n.
<b>CTLn</b> (n=1, 3, 5)	<b>AUTO, SAFE, OFF</b>	<b>AUTO, SAFE, OFF</b>	AUTO: Ion gauge can be turned on & off by the controlling gauge (PR/CP). SAFE, Ion gauge can be turned off, but, not be turned on by the controlling gauge. If no PR/CP exists, this function cannot be enabled.
<b>AFn</b> (n=1,3, 5)	<b>1 or 2</b>	<b>1 or 2</b>	Query or set active filament for HC.
<b>ECn</b> (n=1,3, 5)	<b>20UA 100UA AUTO20 AUTO100</b>	<b>20UA 100UA AUTO20 AUTO100</b>	Query or set emission current.
<b>GCn</b> (n=1,3, 5)	<b>d.dd E±ee</b> (d,e=0 to 9)	<b>d.dd E±ee</b> (d,e=0 to 9)	Query or set a gas correction factor for a HC gauge on Channel n. Valid range is from 0.1 to 50. GT must be set to CUSTOM.
<b>CPn</b> (n=1,3, 5)	<b>ON or OFF</b>	<b>ON or OFF</b>	Query the channel power status for PR, CP, HC or high voltage status for CC. Turn on/off the channel power for PR, CP, HC, or high voltage for CC).
<b>SEn</b> (n=1,3, 5)	<b>d.dd E±ee</b> (d,e=0 to 9)	<b>d.dd E±ee</b> (d,e=0 to 9)	Query or set a gas sensitivity for a HC gauge on Channel n. Valid range is from 1 to 50.
<b>DGn</b> (n=1,3, 5)	<b>ON or OFF</b>	<b>ON or OFF</b>	Query the HC degas status Turn on/off degas
<b>DGTn</b> (n=1,3, 5)	<b>d</b> (d=5-240)	<b>d</b> (d=5-240)	Query and set the HC degas time.
<b>GTn</b> (n=1,3, 5)	<b>Nitrogen Argon Helium Custom</b>	<b>Nitrogen Argon Helium Custom</b>	Query or set a gas type for HC/CC on channel n. When Custom is selected, one can select GC value other than N <sub>2</sub> , Ar or He.
<b>Tn</b> (n=1,3, 5)		<b>W, O, P, D, C, R, F, N, H</b>	Ion gauge status query. W = WAIT O = OFF P = PROTECT D = DEGAS C = Control R = Rear panel Ctrl off F = HC filament fault N = No gauge

Table 8-18 946 Cold and Hot Cathode Control Commands

## 8.13 MFC Control Commands

Command	Parameter	Response	Function
<b>FRn</b> (n=1 to 6)	Read flow on Channel n	<b>d.dd0E±ee</b> (d,e=0 to 9)	Query flow reading in SCCM for MFC on Channel n.
<b>QSFn</b> (n=1 to 6)	<b>d.dd E±ee</b> (d,e=0 to 9)	<b>d.dd E±ee</b> (d,e=0 to 9)	Query or set a scale factor for a MFC on Channel n. Valid range is from 0.1 to 10.
<b>RNGn</b> (n=1 to 6)	<b>0.1 to 1E+6</b>	<b>0.1 to 1E+6</b>	Query or set the full scale nominal range for a MFC. Valid ranges are 1.0 to 1000000 sccm.
<b>QZn</b> (n=1 to 6)		<b>OK or NAK</b>	Zero a MFC on channel n. Execute only when flow reading is less than 5% of full scale.
<b>QSPn</b> (n=1 to 6)	<b>d.dd E±ee</b> (d,e=0 to 9)	<b>d.dd E±ee</b> (d,e=0 to 9)	Query and set the flow set point for a MFC on channel n. If the channel is set to set point mode, this is the true flow rate set point. If the channel is set to Pctrl mode, this is the startinf flow rate for the MFC. If the channel is set to RatioM or RatioA mode, this is the set point for ratio control. The maximum set point value is half of the full scale under the ratio control mode.
<b>QMDn</b> (n=1 to 6)	<b>Open</b> <b>Close</b> <b>Setpoint</b>	<b>OPEN</b> <b>CLOSE</b> <b>SETPOINT</b> <b>PCTRL</b> <b>RATIO</b> <b>PRESET</b>	Query or set the operation mode for a MFC on channel n.

Table 8-19 946 MFC Serial Control Commands

## 8.14 Pressure (Valve) Control Commands

Command	Parameter	Response	Function
<b>VTP</b>	<b>148</b> <b>248</b> <b>153</b> <b>154</b> <b>T3B</b>	<b>148</b> <b>248</b> <b>153</b> <b>154</b> <b>T3B</b>	Query or set the type of valve connected to valve control board.
<b>VMD</b>	<b>Open</b> <b>Close</b> <b>Manual</b>	<b>OPEN</b> <b>CLOSE</b> <b>SETPOINT</b> <b>AUTO</b> <b>MANUAL</b> <b>PRESET</b>	Query or set the operation mode for the valve connected to the pressure control board.  When you turn PID control off valve mode goes to PRESET
<b>VSP</b>	<b>d.dd E±ee</b> (d,e=0 to 9)	<b>d.dd E±ee</b> (d,e=0 to 9)	Set and query the position set point for valve.
<b>VPOS</b>	<b>d.dd E±ee</b> (d,e=0 to 9)	<b>d.dd E±ee</b> (d,e=0 to 9)	Query the current position of valve.

Table 8-20 946 Pressure (Valve) Serial Control Commands

## 8.15 PID Recipe Setting Commands

Command	Parameter	Response	Function
RCPn	n (n=1 to 8)	n (n=1 to 8)	Set or query the active recipe number.
RDCH?n RDCH!n:	A1, B1, A2, B2, C1, C2, Rat, Vlv	n:CH (n=1 to 8, CH=A1, A2, B1, B2, C1, C2, Rat, Vlv, NA)	Set or query the MFC channel for PID pressure control associated with recipe n.
RPCH?n RPCH!n:	A1, B1, A2, B2, C1, C2, PC1, PC2	n:CH (n=1 to 8, CH=A1, A2, B1, B2, C1, C2, NA)	Set or query the pressure channel for PID pressure control associated with recipe n.
RPSP?n RPSP!n:	d.dd E±ee (d,e=0 to 9)	n:d.dd E±ee (n=1 to 8) (d,e=0 to 9)	Set or query the pressure set point for PID pressure control associated with recipe n.
RKP?n RKP!n:	d.dd E±ee (d,e=0 to 9)	n:d.dd E±ee (n=1 to 8) (d,e=0 to 9)	Set or query the proportional control gain Kp for PID pressure control associated with current n. Valid range is from 0.00002 to 10000.0, default setting is 10.
RTI?n RTI!n:	d.dd E±ee (d,e=0 to 9)	n:d.dd E±ee (n=1 to 8) (d,e=0 to 9)	Set or query the Integral time constant for PID pressure control associated with recipe n. Valid range is from 0.01 to 10000, default setting is 1.
RTD?n RTD!n:	d.dd E±ee (d,e=0 to 9)	n:d.dd E±ee (n=1 to 8) (d,e=0 to 9)	Set or query the derivative time constant for PID pressure control associated with recipe n. Valid range is from 0 to 1000, default setting is 0.5.
RCEI?n RCEI!n:	d.dd E±ee (d,e=0 to 9)	n:d.dd E±ee (n=1 to 8) (d,e=0 to 9)	Set or query the CEILING parameter for PID pressure control associated with recipe n. Valid range is from 10+BASE to 100 of full scale, default setting is 100.
RBAS?n RBAS!n:	d.dd E±ee (d,e=0 to 9)	n:d.dd E±ee (n=1 to 8) (d,e=0 to 9)	Set or query the BASE parameter for PID pressure control associated with recipe n. Valid range is from 0 to CEILING -10 of full scale, default setting is 0.
RPST?n RPST!n:	d.dd E±ee (d,e=0 to 9)	n:d.dd E±ee (n=1 to 8) (d,e=0 to 9)	Set or query the PRESET parameter for PID pressure control associated with current active recipe n. Valid range is from 0 to 100 of full scale, default setting is 99.
RSTR?n RSTR!n:	d.dd E±ee (d,e=0 to 9)	n:d.dd E±ee (n=1 to 8) (d,e=0 to 9)	Set or query the START parameter for PID pressure control associated with recipe n. Valid range is from 0 to 100 of full scale, default setting is 0.
REND?n REND!n:	d.dd E±ee (d,e=0 to 9)	n:d.dd E±ee (n=1 to 8) (d,e=0 to 9)	Set or query the END parameter for PID pressure control associated with recipe n. Valid range is from 0 to 100 of full scale, default setting is 0.
RCST?n RCST!n:	d.dd E±ee (d,e=0 to 9)	n:d.dd E±ee (n=1 to 8) (d,e=0 to 9)	Set or query the CtrlStart parameter for PID pressure control associated with recipe n. Valid range is from 0 to 1000 seconds, default setting is 0 seconds.
RDIR?n RDIR!n:	Upstream Downstream	n:UPSTREAM n:DOWNSTREAM	Set or query the DIRECTION parameter for PID pressure control associated with recipe n. Default is Upstream.
RGSB?n RGSB!n:	d (d=0 to 30)	n:d (n=1 to 8) (d=0 to 30)	Set the band for gain scheduled PID control for PID pressure control associated with recipe n. Default is 0.
RGSB?n RGSB!n:	d (d=1 to 200)	n:d (n=1 to 8) (d=1 to 200)	Set the gain for gain scheduled PID control for PID pressure control associated with recipe n. Default is 1.

Table 8-21 946 Recipe Serial Setting Commands



Example 1: To query the proportional gain Kp for recipe 3: @001RKP?3;FF)

Example 2: To set control setpoint pressure to 50 Torr for recipe 1: @005RPSP!1:5.0E+1;FF)



The n: argument in both query and set command may be omitted (@254RPSP!2.5E+2;FF) if you query or set parameters within current active recipe.

## 8.16 Ratio Recipe Setting Commands

Command	Parameter	Response	Function
RRCP	n (n=1 to 4)	n (n=1 to 4)	Set or query the active ratio recipe number.
RRQm?n RRQm!n:	d.dd E±ee (d,e=0 to 9)	n:d.dd E±ee (n=1 to 4) (m=1 to 6) (d,e=0 to 9)	Set or query the flow rate for ratio control channel m associated with ratio recipe n. The ratio channel is disabled if the flow rate is set to zero.

Table 8-22 Ratio Recipe Serial Setting Commands



Ratio recipe serial commands can only query or set parameters within current active recipe. It is recommended to run @254RRCP!n;FF first to set the active recipe before modifying recipe parameters.

## 8.17 PID/Ratio Control Activation Command

PID	ON, OFF	ON, OFF, NAK	Start or stop the PID pressure control using current active recipe.
RM	ON, OFF	ON, OFF, NAK	Start or stop the manual pressure control using current active recipe.
RF	ddd (0 to 200)	ddd (0 to 200)	Set or query the ratio control factor. The RF! Command will also switch the auto ratio to manual ratio control.
RCP	n (n=1 to 8)	n (n=1 to 8)	Set or query the active recipe number.
RRCP	n (n=1 to 4)	n (n=1 to 4)	Set or query the active ratio recipe number.

Table 8-23 PID and Ratio Control Activation Commands



## 8.18 System Commands

Command	Parameter	Response	Function
AD	aaa (aaa=001 to 253)	aaa (aaa=001 to 253)	Query or set controller address (1 to 253) 254 is reserved for broadcasting. Default = 253.
BR	#	#	Query or set baud rate (valid # = 9600, 19200, 38400, 57600, 115200), default = 9600.
PAR	NONE EVEN ODD	NONE EVEN ODD	Query or set the parity for the controller. Default=NONE.
DLY	t msec	t msec	485 time delay, t must $\geq 1$ for reliable 485 communication. Default = 8 msec.
U	Unit	Unit	Pressure unit, Unit=Torr, MBAR, PASCAL, Micron
DM	STD or LRG	STD or LRG	Display mode: either standard display, or large font display. Default = STD.
DF	Default PatchZ HighR	Default PatchZ HighR	Display format: either default, patch zero, or high resolution (only for HC and CC). Default = Default.
LOCK	ON or OFF	ON or OFF	Enable (ON) or disable (OFF) front panel lock
CAL	Enable Disable	Enable Disable	Enable or disable User Calibration, default = Enable.
SPM	Enable Disable	Enable Disable	Enable or disable parameter setting, default = Enable.
MT		T1,T2,T3,T4	Display the sensor module type. T1, T2, T3=(CC, HC, CM, PR, FC, NC). NC= no connection. T4=(NA, PF, PC)
STn (n=A, B, C)		S1S2	Display the connected sensor type on the specified module (A, B, or C). S1,S2=CC,PR,CP,CM,FC,HC, NG. NC=no connection.
MD		937B or 946	Type of controller, either 937B, or 946.
FDn (n=1 to 6)		OK	Factory default for Pirani sensor module. This will reset the user calibration to factory default.
FDS		OK	Factory default for system setup (including address, unit, baud rate, recipes, combination, display format, screen saver)
FVn (n=1 to 6)		d.dd (d=0 to 9)	Firmware version n=1=Slot A; n=2=Slot B; n=3=Slot C n=4=AIO; n=5=COMM; n=6=Main
SN		10 digit SN	Display the serial number of the unit.
SNn (n=1 to 6)	Read serial number in slot n	10 digit SN	Display the serial number of the card in slot A, B, C, CO M, Analog and Main
SPCn (n=1 or 2)	HH,MM,LL	HH,MM,LL	Set or query the combination channel setting. HH: The channel for HP sensor; MM: The channel for MP sensor; LL: The channel for LP sensor. Valid values for HH, MM, or LL are A1, A2, B1, B2, C1, C2, or NA. Default is NA.
EPCn (n=1 or 2)	Enable Disable	Enable Disable	Enable or disable the combination channel. When the combination channel is disabled, the output is 10 V.
DLTn (n=1 to 6)	LIN or LOG	LIN or LOG	Query or set the type of DAC linear (LIN, $V=A*P$ ) of logarithmic linear (LOG, $V=A*\text{Log}P+B$ ) output. Default setting is LOG. (Only LOG is allowed for combined output)

<b>DLAn</b> (n=0 to 6)	<b>d.dd E±ee</b> (d,e=0 to 9)	<b>d.dd E±ee</b> (d,e=0 to 9)	Query or set the DAC slope parameter A. Default value is 0.6. Use n=0 for combination output. Valid range is from 0.5 to 5 when DLT is set to LOG, and 1E-4 to 1E+8 when DLT is set to LIN.
<b>DLBn</b> (n=0 to 6)	<b>d.dd E±ee</b> (d,e=0 to 9)	<b>d.dd E±ee</b> (d,e=0 to 9)	Query or set the DAC offset parameter B. Default value is 7.2. Use n=0 for combination output. Valid range is from -20 to 20 when DLT is set to LOG, and always equals to zero when DLT is set to LIN.
<b>IU</b>	<b>ON or OFF</b>	<b>ON or OFF</b>	Force the use of international pressure unit (Pascal).
<b>XDL</b>			Erase the first page of the memory for preparing the firmware downloading using Sam-BA after power cycle of the controller.
<b>SEM</b>	<b>TXT or CODE</b>	<b>TXT or CODE</b>	Set the NAK error code response. An error text string is returned if it is set to TXT, while an error code is returned if it is set to CODE.
<b>SST</b>	<b>0 to 240</b>	<b>OFF, 1 to 240</b>	Set and query the screen saver time (in minute) when sleep mode (turn off front panel display) is activated. 0 means the screen saver mode is disabled.

**Table 8-24 946 System Commands**

## 8.19 Error Code

When serial commands are used in communicating with 946, an error code will be returned if an invalid command or an invalid parameter is sent. The error code can be displayed in either in TXT or CODE mode, and can be selected by using @254SEM!TXT;FF or @254SEM!CODE;FF command, respectively.

946 Error Code	
CODE	TXT
150	WRONG_GAUGE
151	NO_GAUGE
152	NOT_IONGAUGE
153	NOT_HOTCATHODE
154	NOT_COLD_CATHODE
155	NOT_CAPACITANCE_MANOMETER
156	NOT_PIRANI_OR_CTP
157	NOT_PR_OR_CM
158	NOT_MFC
159	NOT_VLV
160	UNRECOGNIZED_MSG
161	SET_CMD_LOCK
162	RLY_DIR_FIX_FOR_ION
163	INVALID_CHANNEL
164	DIFF_CM
165	INVALID_PID_PARAM
166	PID_IN_PROGRESS
167	INVALID_RATIO_PARAM
168	NOT_IN_DEGAS
169	INVALID_ARGUMENT
172	VALUE_OUT_OF_RANGE
173	INVALID_CTRL_CHAN
175	CMD_QUERY_BYTE_INVALID
176	NO_GAS_TYPE
177	NOT_485
178	CAL_DISABLED
179	SET_POINT_NOT_ENABLED
181	COMBINATION_DISABLED
182	INTERNATIONAL_UNIT_ONLY
183	GAS_TYPE_DEFINED
191	NOT_RATIO_MODE
195	CONTROL_SET_POINT_ENABLED
199	PRESSURE_TOO_HIGH_FOR_DEGAS

Table 8-25 946 Serial Communication Error Codes

## 9 Maintenance of Series 946 Controller Modules

There are 3 sensor module slots (A, B, and C) available in the 946 Controller. Sensor module plug-in boards (Pirani/CP, Capacitance Manometer, Cold Cathode, Hot Cathode) can be inserted into any available slot and the controller will automatically recognize the type of the board in the slot. Typically, 946 Controllers are shipped with customer-specified sensor modules and these are tested at the factory.

To change the factory controller configuration or to remove and adjust the appropriate module, follow the steps shown below.

### 9.1 Removing and Installing a Sensor Module



**Lethal voltages are present in the controller when it is powered. Disconnect the power cable before disassembly.**



**Suitable ESD handling precautions should be followed while installing, configuring or adjusting the instrument or any modules.**

To remove a module for modification,

1. Make sure that the 946 power is off, and that the power cord is disconnected
2. Using a #1 Phillips screwdriver, remove the two screws on the top and bottom of the rear panel of the sensor module.
3. Use a small, flat-blade screwdriver to gently pry the sensor module away from the rear panel frame until it slides freely.
4. **Carefully** slide the module out.
5. Place the module on a static-protected workbench.

To installing a module into 946,

1. Make sure that the 946 power is off, and that the power cord is disconnected
2. Align the module to fit and slide freely in the **card guides**, with the internal 32-pin DIN connector end first.
3. Gently slide the module forward (A, B, or C).
4. Using a #1 Phillips screwdriver, tighten two screws on the top and bottom of the rear panel of the module.



**A sensor module (with 32-pin DIN) can only be inserted into slots A, B or C. It will not fit into the COMM slot!**

### 9.2 Removing and Installing AIO Module

In the 946 Controller, the power cord receptor, the RS232/485 communication 9-pin D-Sub connector, the 25 pin D-Sub Relay output connector, and the 37-pin D-Sub Analog output connector are all mounted on the same AIO back panel.

To remove the AIO module, use the following procedure:

 **Lethal voltages are present in the controller when it is powered. Disconnect the power cable before disassembly.**

 **Suitable ESD handling precautions should be followed while installing, configuring or adjusting the instrument or any modules.**

1. Make sure that the 946 power is off and that the power cord is disconnected.
2. Using a #1 Phillips screwdriver, remove the four (4) screws on the four corner of the rear panel of the AIO module.
3. Place a small, flat-bladed screwdriver at the top right corner of the AIO module (as shown below) and gently pry the AIO module away from the rear panel frame until it slides eely.

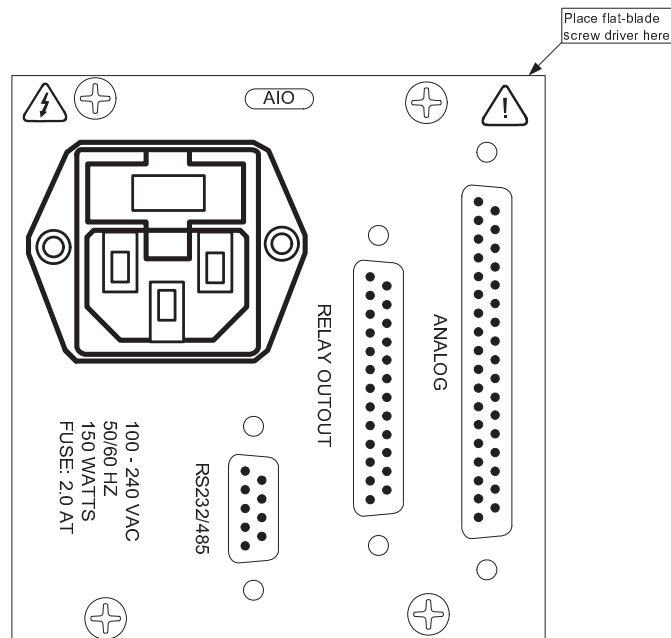

**Figure 9-1 Instructions for Removing AIO Module**

4. Pull the AIO board out by about 2 inches (5 cm)
5. Use needle-nose pliers to remove the 3 wires (Blue, Brown, and Green/Yellow) connected to the back of the power cord receptor
6. Carefully slide the module out
7. Place the module on a static-protected workbench

To install the AIO module, please follow the following procedure:

1. Make sure that the 946 power is off and that the power cord is disconnected

2. Align the module to fit and slide freely in the **card guides**, with the internal 48-pin DIN connector end first.
3. Gently slide the module forward, and stop when the back end of the module is about 2 inches (5 cm) away from the back panel frame.
4. Connect 3 wires to the back of the power cord receptor as show below

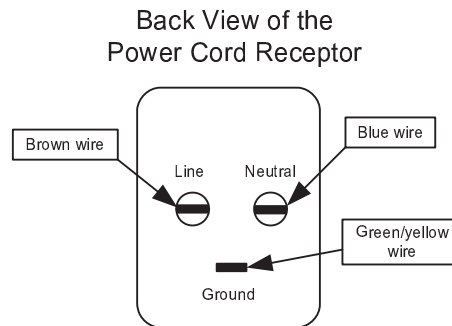

**Figure 9-2 Instruction for Connecting Wire on the Back of the Power Cord Receptor**

5. Gently slide the module forward, and make sure the internal 48-pin DIN connector is engaged.
6. Using a #1 Phillips screwdriver, tighten four (4) screws on the four corners of the rear panel of the module.

### 9.3 Communication Module

In the Series 946, the slot labeled “COM” can only be used for the valve pressure control card (PC).

### 9.4 Power Supply



**Lethal voltages are present in the controller when it is powered. Disconnect the power cable before disassembly.**



**Suitable ESD handling precautions should be followed while installing, configuring or adjusting the instrument or any modules.**

The power supply used on the 946 Controller is a 150 Watt, open frame switching power supply. This power supply is mounted on the right-hand side panel using four screws. Do not remove the power supply.

Contact HPS™ Products Applications Engineering if it becomes necessary to remove or replace the power supply.

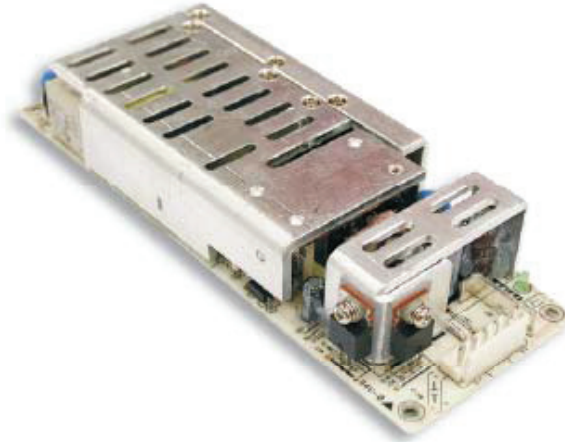

Figure 9-3 The 946 Controller Power Supply

## 9.5 Mounting the 946 Controller

The 946 Controller was designed for both rack mounting and bench top use. In both cases, leave at least 1 inch open above the perforated panels to ensure adequate ventilation of the controller. Side clearance is not required.

To accommodate connectors and cables, leave open about 3 inches of clearance behind the rear panel.

Adhesive backed rubber pads are provided for bench top use. Remove the adhesive backing from each pad and apply one to each corner of the bottom surface.

Optional mounting hardware is available for mounting the 946 Controller in a 19 inch rack.

- Mounting a single 946 Controller into a 19" rack (HPS<sup>®</sup> Part # 100005651)
  1. Attach the faceplate (3.5"x5.5") to each side of the 946 front panel using the four 10-32 bolts provided. Secure the bolts with the nuts included in the kit.
  2. Secure this assembly to the rack using the ¼" screws provided. It may be necessary to loosen the 10-32 bolts securing the faceplates in order to align the holes with the mounting holes on the rack.
  
- Mounting the 946 Controller with another ½ rack instrument (HPS<sup>®</sup> Part # 100007700)
  1. Attach the ½ rack instrument to the 946 Controller using the small splicing plate and the four 10-32 bolts provided. The splicing plate is used to connect the front panel of each instrument together.
  2. Secure this assembly to the rack using the ¼" screws provided. It may be necessary to loosen the 10-32 bolts securing the splicing plate in order to align the holes with the mounting holes on the rack.



**All items in the kit may not be necessary, depending on the mounting configuration.**

Contact HPS<sup>™</sup> Products Applications Engineering for solutions to other mounting configurations.

## 9.6 AC Power Cord

The 946 Controller includes a standard 100-240 VAC, 50/60 Hz power connection with a female IEC 60320 connector. If the power source is different, use only a harmonized, detachable cord set with conductors having a cross-sectional area equal to or greater than 0.75 mm<sup>2</sup>. The power cord should be approved by a qualified agency such as UL, VDE, Semko, or SEV.



**Properly ground the controller and vacuum system.**

The 946 Controller is grounded through the ground conductor of the power cord. If the protective ground connection is lost, all accessible conductive parts may pose a risk of electrical shock. Plug the cord into a properly grounded outlet only.



**Do not exceed the manufacturer's specifications when applying voltage. Electrical shock may result.**



# 10 Maintenance and Service of HPS<sup>®</sup> Vacuum Sensors

## 10.1 431 Cold Cathode Sensor

### 10.1.1 Cold Cathode Theory

Ambient gas molecules are ionized by a high voltage discharge in Cold Cathode sensors and gauge sensitivity is enhanced by the presence of a magnetic field. HPS<sup>®</sup> Products Group's Cold Cathode sensors are not standard Penning sensors in that they employ an inverted magnetron design that includes an isolation collector, as shown in Figure 11-1. This makes the sensor less susceptible to contamination and allows a wider range of pressure measurement.

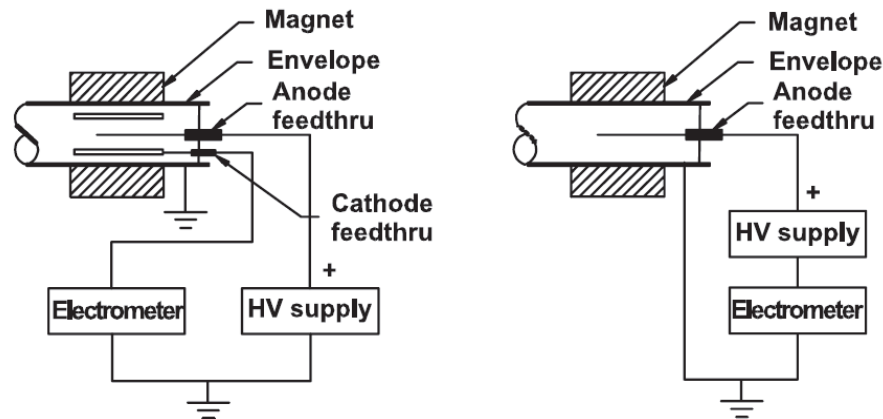

**Figure 10-1 A comparison of Inverted Magnetron (left) and Penning (right) Cold Cathode Gauges**

Cold Cathode ionization sensors have inherent advantages over Hot Cathode sensors. These include:

- No filament to break or burn out, which makes the gauge immune to inrushes of air. As well, it is relatively insensitive to damage due to vibration.
- No X-ray limit for lower pressure measurements.
- No adjustment for emission current or filament voltage is needed.
- Degassing is not needed.
- Properly designed sensor tubes can be cleaned and reused almost indefinitely.
- The control circuit is simple and reliable, having only one current loop, as compared with a Hot Cathode sensor which has three.
- Less power consumption enables the use of significantly longer cables between the controller and the sensor.

A Cold Cathode sensor consists of a cathode and an anode with a potential difference of several kilovolts between them. The electrodes are surrounded by a magnet, arranged so the magnetic field is perpendicular to the electric field. The crossed electric and magnetic fields cause electrons to follow long spiral trajectories within the sensor, increasing the chance of collisions with gas molecules, thereby providing a significant increase in ionization efficiency over a Hot Cathode sensor.

In operation, a near constant circulating electrical current is trapped by the crossed fields in which the collisions between electrons and residual gas molecules produce ions that are collected by the cathode. The relationship between sensor current and pressure is  $i = kP^n$ , where  $i$  is the sensor ion current,  $k$  is

a constant,  $P$  is the pressure, and  $n$  is a constant (in the range of 1.00 to 1.15). This equation is valid for pressures ranging from  $10^{-3}$  to  $10^{-8}$  Torr, depending on the series resistor used. At pressures around  $10^{-6}$  Torr, the sensitivities of 1 to 10A/Torr are not unusual.

The initiation of electron impact events within a Cold Cathode sensor depends upon certain chance events such as field emission or cosmic ray production of the first free electron. Electron-molecule collisions thereafter produce additional electron/ion pairs during the electrons' transit between the electrodes. The discharge rapidly builds to a stable value. Start of the discharge normally requires a very short time at  $10^{-6}$  Torr or above, a few minutes at  $10^{-8}$  Torr, and longer times at lower pressures.

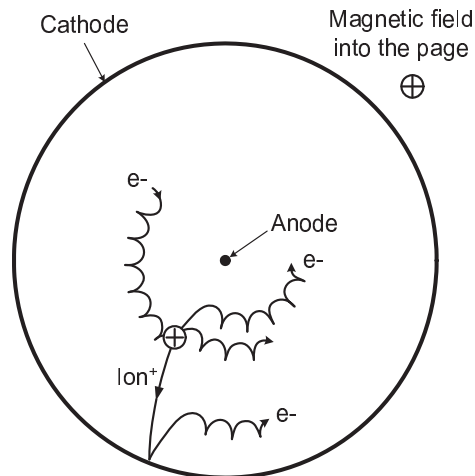

**Figure 10-2 Electron Orbits and Ion Production in an Inverted Magnetron**

There are issues that should be considered in the design of Cold Cathode sensors. For instance, at high pressures the current increases and sputtering of the cathode can become a problem. A large series resistor reduces sputtering. Voltage across the tube is pressure dependent in the range between  $10^{-4}$  to  $10^{-2}$  Torr and this can be used to extend the measurement range of the Cold Cathode to  $10^{-2}$  Torr. Of the various electrode configurations possible in Cold Cathode gauges, it has been found that single feed-through Cold Cathodes can suffer from spurious currents due to insulator leakage and field emission that mask the small, pressure dependent ionization currents.

HPS® Products Group Cold Cathode sensors use an inverted magnetron with separate feed-throughs for the anode high voltage and the cathode current. This configuration has a cylindrical cathode, a central wire anode, and an external cylindrical magnet which provides an axial field. The cathode is isolated from the grounded metal housing. The inverted magnetron geometry produces more stable signal output, and also works well to low pressure without risk of extinguishing the discharge.

## 10.1.2 Maintenance of Series 431/422 Cold Cathode Sensor

### 10.1.2.1 Disassembling the Series 431/422 Sensor

The Series 431/422 sensor consists of three subassemblies – the backshell; the internal; and the body subassemblies. Only the internal and body subassemblies are exposed to vacuum.

To disassemble the sensor, remove the backshell subassembly as follows (Steps 1 through 4 are not necessary when replacing internal parts):

1. Remove the two 4-40 x 1/4" Phillips head SEMS screws **2** and slide the backshell **9** off of the sensor.

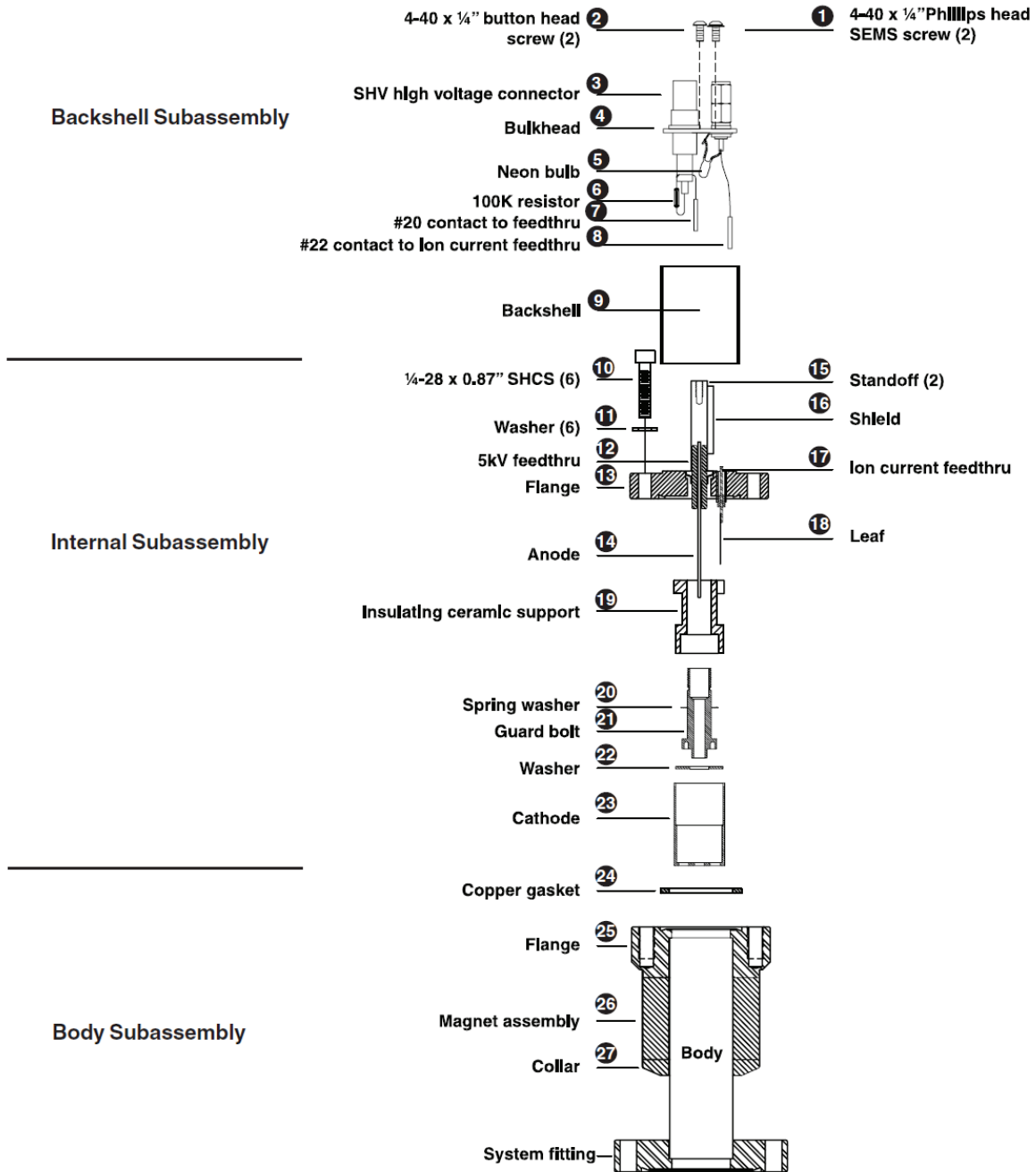

Figure 10-3 Exploded View of the 431/422 Cold Cathode Gauge Assembly

- Remove the two 4-40 x 1/4" button head screws (1).
- Use needle nose pliers to pull the #22 contact (8) carefully off of the ion current feed-through (17).
- Pull the #20 contact (7) off of the 5kV feed-through (12) taking the entire bulkhead (4) with it (do not remove the SHV and BNC connectors from the bulkhead).

5. Remove the six ¼-28 x 0.875" socket head cap screws **10** and pull the back flange **13** free. Note that these screws are silver-plated for lubricity and should be used only once. They may be re-lubricated with a dry lubricant such as molybdenum disulfide, though new silver-plated screws are recommended. The copper gasket **24** must be replaced with a standard 2 1/8" CF flange gasket.



**The cathode and anode assemblies are attached to the flange. Disassembly should proceed from the bottom to the top of the internal assembly drawing.**

6. To remove the cathode **23**, release the two integral, spring-loaded ears that are hooked over the shoulder of the ceramic insulating support **19**.
7. Gently pull up on the ear until it just clears the outer diameter of the ceramic insulating support **19**.



**Position the small Elgiloy® leaf **18** used to connect the ion current feed-through **17** to the cathode. The rotational position of the cathode with respect to the leaf is not critical, however, be careful not to bend the leaf.**

8. Slide the cathode **23** and washer **22** off of the insulating support.
9. The insulating support is captured by the guard bolt **21**. Remove this using a spanner wrench and unscrew the guard bolt from the flange **13**.



**There is a small curved spring washer **20** under the head of the guard bolt. This spring washer holds the insulating support tight, preloads the guard bolt to resist unscrewing due to possible vibration, and provides compliance for differential thermal expansion during bakeout.**

### 10.1.2.2 Cleaning the Series 431/422 Sensor

Depending on the degree of contamination and application of the sensor, the internal parts may be cleaned — either ultrasonically, with mild abrasives, or chemically.



**Do not touch any vacuum exposed part after cleaning unless wearing gloves.**

Ultrasonic cleaning should use only high quality detergents compatible with aluminum (e. g. ALCONOX®). Scrub surfaces with a mild abrasive to remove most contamination. Scotch-Brite™ or fine emery cloth may be effective. Rinse with alcohol.

Clean aluminum and ceramic parts chemically in a wash (not recommended for semiconductor processing), such as a 5 to 20% sodium hydroxide solution, at room temperature (20°C) for one minute. Follow with a preliminary rinse of deionized water. Remove smut (the black residue left on aluminum parts) in a 50 to 70% nitric acid dip for about 5 minutes.

### 10.1.2.3 Assembling the Series 431/422 Sensor

To reassemble the sensor, reverse the order of procedures used during disassembly. Note the following tightening procedure for the guard bolt. The bolt has a 3/8" 40 thread design that is delicate.

1. Finger tighten the guard bolt to compress the spring washer and then back off one turn. Do not over tighten as this will remove all compliance from the spring washer and possibly damage the aluminum 3/8"-40 thread.

2. Verify that the anode **14** is well-centered within the bore of the guard bolt.
3. If it is off center, carefully bend it back into position and continue with the assembly.

#### 10.1.2.4 Preparing the Sensor for Bakeout

The 431/422 sensor, including the LEMO connectors in the bulkhead, will withstand bakeout up to 250°C. Additionally, the sensor may be operated during bakeout if cables and connectors with appropriate temperature ratings are used. Cables or connectors rated to temperatures less than the bakeout temperature need to be disconnected from the sensor for bakeout. In applications requiring repeated bakeouts, the use of bakable connectors and cables is suggested. To prepare the sensor for bakeout up to 125°C, remove the high voltage and ion current cables only.

#### 10.1.2.5 Testing a Cold Cathode Sensor

HPS cold cathode sensors contain anode and cathode (collector) electrodes. Test the sensor with an ohmmeter. There should be no shorts between the electrodes or from the electrodes to the sensor body.

### 10.2 Maintenance of Series 423 I-MAG® Cold Cathode Sensor

#### 10.2.1 Connecting the I-MAG Sensor

Mount the Sensor to a grounded vacuum system.

If the I-MAG Sensor has a CF flange, remove the magnet to allow clearance for bolt installation. When replacing the magnet, note that it is keyed to the sensor body to protect the feed-through pins from damage. The pins should be straight and centered.

For grounding, use a conductive, all-metal clamp to mount a KF 25 or KF 40 flanged sensor body.

Connect the cable to the sensor and to the 946 Controller before turning on your system. Tighten the thumbscrew on top of the cable to make sure it is securely in place.

#### 10.2.2 Disassembling the I-MAG Sensor

1. Clean tweezers and clean smooth-jaw, needle-nose pliers are required.
2. Turn off the power to the 946 Controller.
3. Loosen the thumbscrew on top of the sensor cable and remove the cable.
4. Loosen the two flat head screws **15**.
5. Remove the magnet **14**.
6. Using the smooth-jaw, needle-nose pliers, firmly grab the compression spring **3** at the tip closest to the flange.
7. Pull on the compression spring **3** while rotating to free it from the formed groove of the sensor body **9**. Continue to pull until the compression spring **3** is completely free.
8. With the vacuum port facing up, carefully remove the remaining components (**4** through **8**) from the sensor body.

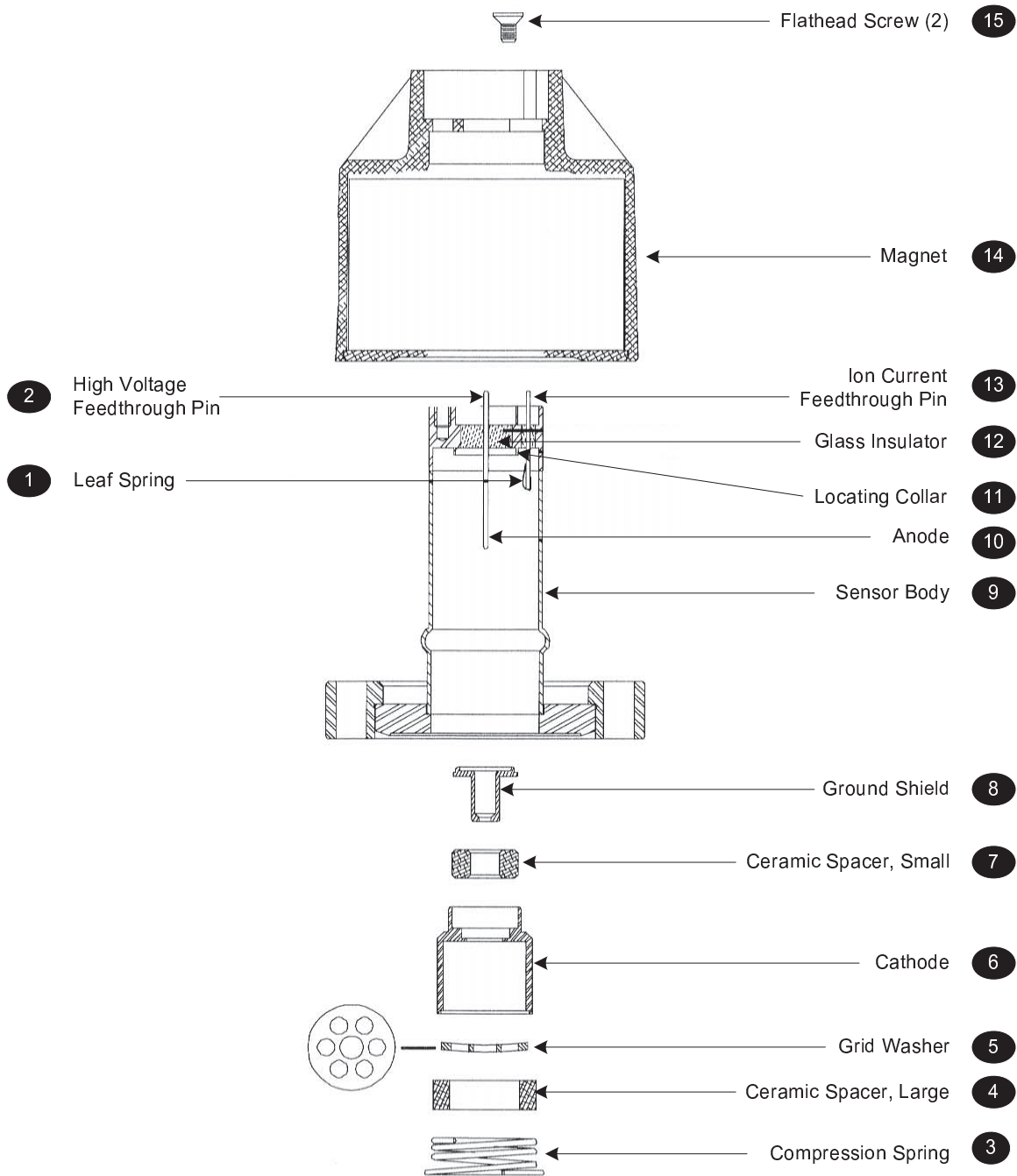

Figure 10-4 Exploded View of the Series 423 I-MAG Cold Cathode Gauge Sensor

**STOP** Do not bend the anode **10** or the leaf spring **1** on the ion current feed-through pin when assembling or disassembling the sensor.

### 10.2.3 Cleaning the I-MAG Sensor

Depending on the degree of contamination and the application of the sensor, the internal parts may be cleaned — either ultrasonically, with mild abrasives, or chemically.



**Do not touch any vacuum-exposed part after cleaning unless wearing gloves.**

Ultrasonically clean surfaces using only high quality detergents compatible with aluminum (i.e. ALCONOX®).

Scrub with a mild abrasive to remove most contamination. Scotch-Brite™ or fine emery cloth may be effective. Rinse with alcohol.



**Clean aluminum and ceramic parts chemically in a wash such as a 5 to 20% sodium hydroxide solution, at room temperature (20°C) for one minute (not recommended for semiconductor processing). Follow with a preliminary rinse with deionized water. Remove smut (the black residue left on aluminum parts) in a 50 to 70% nitric acid dip for about 5 minutes.**



**Chemical cleaning should not be used to clean the anode; mild abrasives or ultrasonic cleaning are acceptable.**



**Do not damage the leaf spring 1 while cleaning the sensor.**

Each of the cleaning methods described above should be followed with multiple rinses of deionized water.

Dry all internal components and the sensor body 9 in a clean oven set at 150°C. The two ceramic spacers, 4 and 7, are slightly porous and will require longer drying time in the oven to drive off the absorbed water.

## 10.2.4 Assembling the I-MAG Sensor



**Wear gloves and assemble with clean tools.**

1. Roll the sensor body 9 on a flat surface and, looking down the port, check the anode 10 for any radial runout motion. It should be straight and centered with the sensor body 9 for proper operation.
2. Install the ground shield 8 using tweezers. Make sure that the ground shield 8 drops into the locating collar 11.
3. Slide the small ceramic spacer 7 over the small end of the ground shield 8.
4. Check that the leaf spring 1 will contact the base of the cathode 6, as shown to the right. If not, remove the small ceramic spacer 7 and the ground shield 8, and gently bend the leaf spring 1 towards the anode 10 and then replace the ground shield 8 and ceramic spacer 7.

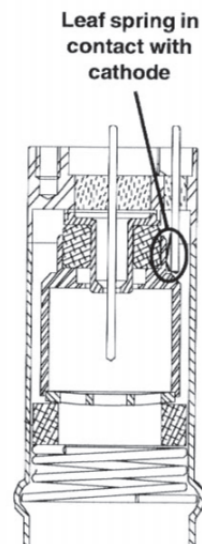

5. Slide the cathode **6**, the grid washer **5**, and the large ceramic spacer **4** into place. The grid washer **5** has a concave shape. Refer to the figures to see its installation orientation.
6. Insert the small end of the compression spring **3** into the sensor body **9**.
7. Using your thumbs, push the larger end of the spring into the sensor body **9** until it is contained within the tube's inside diameter.
8. Using the smooth-jaw, needle-nose pliers, work the compression spring **3** down into the sensor body **9** until it is fully seated in the formed groove.
9. Inspect the ground shield **8** and the grid washer **5** to verify they are centered with respect to the anode **10**.
10. If adjustment is needed, gently reposition the grid washer/cathode assembly, taking care not to scratch the grid washer **5**.

It is recommended that the resistance between the ion current feed-through pin **13** and the grid washer **5** be measured to verify that the leaf spring **1** is in contact with the cathode **6**. The measurement should indicate a short circuit between them. There should be an open circuit between the ion current feed-through pin **13** and both the high voltage feed-through pin **2** and the sensor body **9**.

Once this procedure is complete, the I-MAG Sensor is ready for installation. If it is not to be installed immediately, cover the flange with clean, vacuum grade aluminum foil and cap with a flange protector.

## 10.2.5 Preparing the Sensor for Bakeout

To prepare the sensor for bakeout at up to 400°C, remove the sensor cable and magnet assembly as described in "Disassembling the I-MAG sensor".

## 10.3 Maintenance of Low Power Nude and Mini BA Hot Cathode Sensors

### 10.3.1 Hot Cathode Theory

Hot Cathode Ionization gauges use the electrons emitted from a hot filament (thermionic electrons) to create ions in a surrounding gas. The ion numbers are in proportion to the ambient gas pressure. Electrons are accelerated through the gauge by a potential difference between the hot, emitting filament and a positively charged surrounding grid (anode). The energy acquired by the electrons as they are accelerated by the electric field in the gauge is sufficient to ionize resident ambient gas molecules. The positively charged ions created by this collision ionization are attracted to the negatively biased ion collector within the gauge where they are neutralized by an electron current. The gas molecules are singly ionized and there is a one-to-one correspondence between the number of ions neutralized and the magnitude of the neutralizing electron current. Hence the electron current is often called the "ion current" and this is proportional to the pressure in the gauge. The "ion current" is measured by the electrometer and converted to a pressure indication on 946 display.

The Bayard Alpert (BA) gauge is one of the most popular types of hot cathodes gauges. They are available in glass envelopes, or mounted on a flange (the latter configuration is often referred to as a nude gauge). The main advantage of the BA configuration is its reduced susceptibility to X-ray induced errors. This is achieved through the adoption of a small diameter ion collector that minimizes the area exposed to the soft X-ray emitted from the grid. X-ray emission from the grid is an undesirable side effect of electron impact upon the grid surface since some of these X-ray strike the ion collector, releasing electrons by the photoelectric effect. This photoelectric current is not related to the pressure but is nevertheless added to the measurement of current determined by the electrometer. The photoelectric



current can fully mask the ion current at low pressure (around  $1 \times 10^{-10}$  Torr) and this limits the pressure measurement capabilities of the BA gauge.

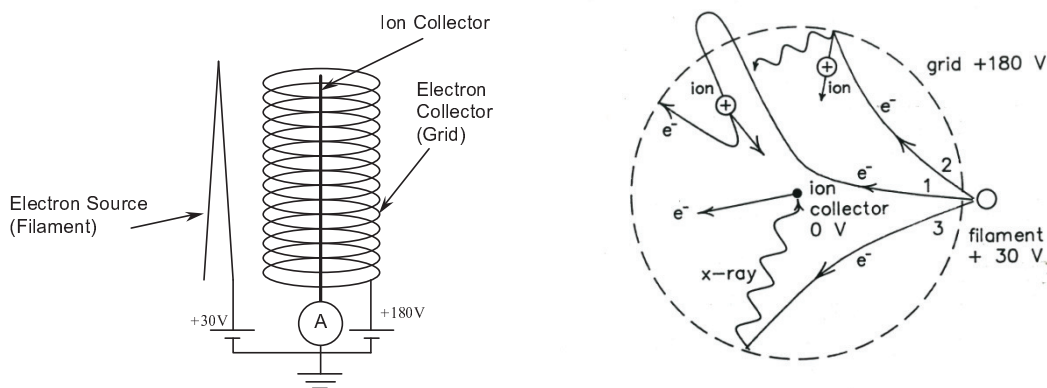

**Figure 10-5 BA Gauge Structure and Electron Process Inside the Gauge**

The collection ion current  $i_+$  is related to the pressure  $P$  and emission current  $i_-$  by the equation  $i_+ = kPi_-$  where,  $k$  is the gauge sensitivity which depends strongly upon the gauge structure and operating condition. Typical gauge sensitivity for nitrogen is around  $7.5$  to  $15 \text{ Torr}^{-1}$ .

To reduce the outgassing in gauge to a negligible level, and minimize the effect of ESD (electron stimulated desorption) on high vacuum measurement, high temperature degassing techniques are used to drive off any adsorbed gas molecules from the surface of the anode grid. Electrode heating during the degas process is accomplished either by electron bombardment (EB degas) or by passing a high current through the grid ( $I^2R$  degas). EB degas technique is accomplished in the 946 Controller by increasing the emission current from the Hot Cathode.

### 10.3.2 Cleaning the Hot Cathode Sensor

Roughing pump oils and other fluids that condense and/or decompose on surfaces within the gauge (i.e. grid and collector surfaces) contaminate the sensor and can cause calibration shift. Degassing of the gauge can remove surface contamination on the grid and collector, however, severe contamination of the grid structure may require a replacement of the sensor.

Although the feed-through insulators are shielded, in some applications conducting films or other forms of electrically conductive pathways may be formed on insulator surfaces. When this happens it creates a leakage path on the insulator that can produce false low pressure reading. In these cases the sensor may have to be replaced.



**Unlike with Cold Cathode gauge, it is not advisable to clean the Hot Cathode sensor. Attempts to clean the sensor may either deform or break the gauge structure.**

### 10.3.3 Testing the Hot Cathode Sensor



**This test will only identify a non-functional sensor. It will not detect damage from contamination, misuse or rough handling that can affect the calibration of a Hot Cathode gauge.**

The most common cause of sensor failure is filament failure. To check for this failure mode, test the sensor using an ohmmeter with less than 5 mA of current. The resistance readings of a normal hot cathode sensor are shown in Table 11-1. The resistance between the two pins of each filament is of particular importance. This test may be applied to any hot cathode sensor operated by 946.

Pin Numbers	Resistance (Ohm) for a good sensor	Resistance (Ohm) for a bad sensor
Between F1 pins	0 - 5	Open (>100 Ohm)
Between F2 pins	0 - 5	Open (>100 Ohm)
Any pin to ground/shell	>10 <sup>6</sup> Ohm	<10 <sup>6</sup> Ohm

**Table 10-1 Resistance Readings of a Normal HC Sensor**

F1 and F2 are identified on the Low Power Nude gauge. For a Mini BA, use the drawing in Figure 11-6 to located F1 and F2.

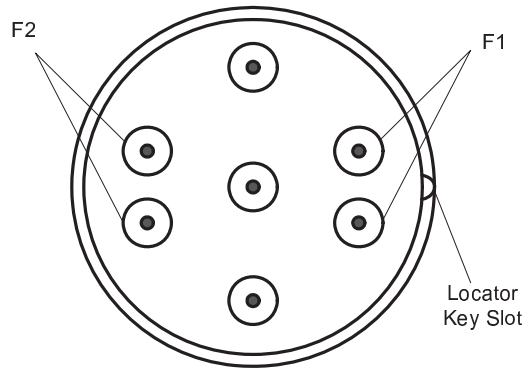
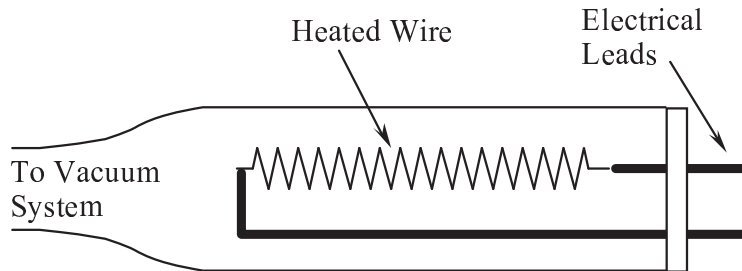

**Figure 10-6 Filament Pin Locator for LPN and Mini BA Gauges**

## 10.4 Maintenance of Pirani Sensors

### 10.4.1 Theory of a Pirani Pressure Sensor

Both standard Pirani and Convection enhanced Pirani gauges can be used with the 946 Controller. In both cases, measurement is based on gas-dependent thermal conductivity of the gas in the vacuum environment. A wire suspended from supports (as shown in Figure 11-7) is heated and maintained at a constant temperature during the measurement process.



**Figure 10-7 Schematic of a Pirani Thermal Conductivity Sensor**

The amount of heat exchanged between the hot wire and cold environment is a function of the pressure when the distance between the hot wire and the cold environment is comparable to the mean free path of the gas molecules (less than about ~20X of the mean free path). When gas pressure is higher, the gas thermal conductivity becomes pressure insensitive and natural convective heat transfer must be employed to improve the gauge sensitivity. This demands the horizontal placement of the sensor tube (as shown in Figure 12-8) for a convection enhanced Pirani used to measure pressures greater than 100 Torr.

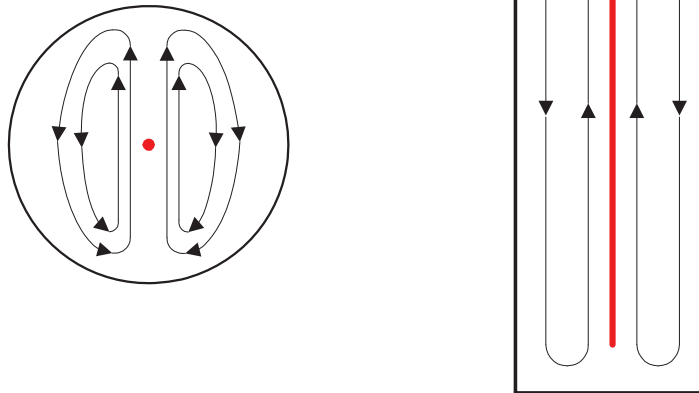

**Figure 10-8 Natural Convection Heater Transfer in Horizontal (left) and Vertical (right) Sensor Tubes.**

The size (diameter) of gas molecules has significant impact on the Pirani sensor. Since smaller molecules (such as helium) move faster in the gas, this gas can transfer more heat energy under the same pressure as compared with a gas composed of heavy molecules (e.g. Argon). This explains why helium is saturated when the pressure is less than 10 Torr.

The standard Pirani sensor will read continuously between  $5 \times 10^{-4}$  to 100 Torr, and, with lower resolution, up to atmospheric pressure.

The Convection Pirani sensor design enhances heat transfer at higher pressures through convection. This sensor will read continuously with full resolution from  $1.0 \times 10^{-3}$  to 1000 Torr.

## 10.4.2 Cleaning the Series 345 Sensor

Roughing pump oils and other fluids condensing or decomposing on the heated filament can contaminate the sensor. This changes the emissivity of the filament, which in turn can cause the calibration to change, especially at low pressure.



**It is not advisable to clean the sensor. Attempts to clean it may either deform or break the filament. The deformed filament can cause gauge errors arising from a shift in the sensor output.**

Replace the sensor if it becomes contaminated (see **Spare Parts and Accessories**).

### 10.4.2.1 Testing the Series 345 Sensor



**This procedure tests function only. Lower levels of sensor damage that are due to contamination or rough handling can affect calibration, but the tube may still be functional.**

The most common cause of sensor failure is a broken filament (checked from pin 4 to pin 6) due to improper handling.

Test the sensor using an ohmmeter with less than 5 mA of current. The resistance readings of a normal Series 345 Sensor measured at atmospheric pressure and at room temperature (20°C) are shown in Table 11-2.

345 D-Sub Pin #	Resistance (Ω)
4 to 7	39
4 to 8	114
6 to 7	31
6 to 8	114
5 to 6	62
3 to 5	345

Table 10-2 Bridge Resistance Value for a Normal 345 Pirani Sensor

### 10.4.3 Cleaning the Series 317 Sensor

Roughing pump oils and other fluids condensing or decomposing on the heated filament can contaminate the sensor. This changes the emissivity of the filament, which in turn can cause the calibration to change, especially at low pressure.



**It is not advisable to clean the Sensor. Attempts to clean it may either deform or break the filament. The deformed filament would then cause additional error due to a shift in the sensor's output.**

Replace the sensor if it becomes contaminated (see **Spare Parts and Accessories**).

#### 10.4.3.1 Testing the Series 317 Sensor

The most common cause of sensor failure is a broken filament. This might be caused by physical abuse or sudden venting of the sensor to atmosphere at the inlet port.

- Using a #1 Phillips head screwdriver, remove the two screws to separate the connector/electronics subassembly from the end of the sensor.
- Check the resistance on the sensor's pins listed in the first column in Table 11-3. Test the sensor using an ohmmeter with less than 5 mA of current. The resistance readings for a normal sensor measured at atmospheric pressure and at room temperature (20°C) are listed in the middle column. If the condition shown in the right column exists, the sensor should be replaced.

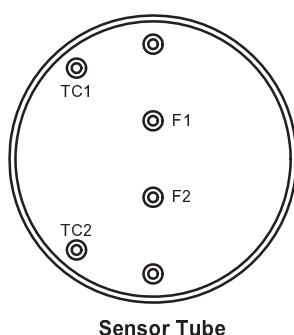

Check	Resistance (Ω)	Results
F1 to F2	20	If higher, filament is broken or burned out.
F1 to sensor port F2 to sensor port	$>20 \times 10^6$	If lower, sensor is damaged or contaminated.
TC1 to TC2	27	If higher, temperature compensation winding is broken.
TC1 to sensor port TC2 to sensor port	$>20 \times 10^6$	If Lower, temperature compensation winding is broken.

Table 10-3 Resistance Values for a Normal 317 Convection Enhanced Pirani Sensor

### 10.4.3.2 Preparing the 317 Sensor for Bakeout

Remove the cable from the sensor. Using a #1 Phillips head screwdriver remove the two screws at the end of the connector/electronics subassembly to separate it from the sensor. The standard Convection Pirani sensor can be baked up to 150°C and the Shielded Convection Pirani sensor can be baked up to 100°C.

A 317 sensor is also available with an aluminum housing. With the electronics removed, it is bakable to 250°C.

Maintenance of Capacitance Manometer

## 10.5 Theory of a Capacitance Manometer

Figure 10-9 Exploded View of a MKS Capacitance Manometer Sensor

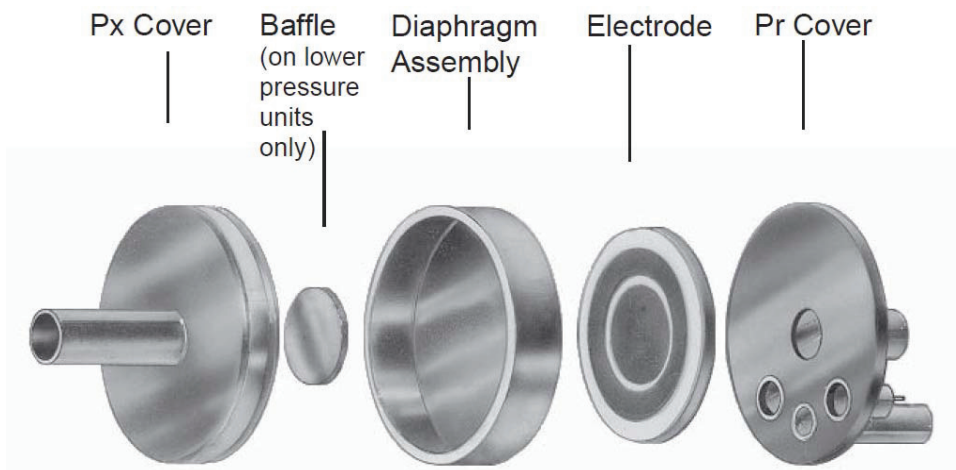

MKS Capacitance Manometers contains a sensor and signal conditioner. The sensor is made up of a tensioned metal diaphragm, one side of which is exposed to the media whose pressure is to be measured. The other (reference) side contains an electrode assembly placed in a reference cavity (see Figure 11-9). Absolute transducers have the reference side factory-sealed under high vacuum ( $10^{-7}$  Torr). The diaphragm deflects with changing pressure — force per unit area — causing a capacitance change between the diaphragm and the adjacent electrode assembly. The high level output signal, current, or DC voltage is linear with pressure, amplified, and self-compensated for thermal stability with ambient temperature changes. Capacitance Manometers should be zeroed on installation. This zero adjustment has no effect on the actual calibration.

### 10.5.1 Repairing the Baratron™ Capacitance Manometer

Repair by the user is not recommended since replacement or movement of PC board components may require complete calibration of the unit. Return to MKS for repair.

# 11 Spare Parts and Accessories

	<i>Part #</i>
<b>Accessories</b>	
USA power cable	103150001
Half rack mounting kit	100005651
Full rack mounting kit	100007700
946 Instruction Manual	100016467
Rebuild kit for Series 421	100006734
Spanner Wrench for 421 tube rebuild	100005279
Rebuild kit for Series 423 I-MAG®	100002353
Adapter, SMA-F to BNC-M	100016120
Adapter, Connector, SMA-M to BNC-F	100016121
Fuse (2X) inside the inlet power connector	100015755
<b>Module, plug-in</b>	
Cold Cathode	100018446
Cold Cathode with TTL	100018448
Hot Cathode (MIG/LPN)	100015641
Dual Capacitance Manometer/Piezo	100015267
Dual Standard Pirani/Convection Pirani	100015132
MFC	100016529
Pressure control	100016609
<b>Serial Firmware Download Adaptor</b>	
Adaptor	100016642
<b>Cable for Capacitance Manometer, Type 722B</b>	
10 ft (3.0 m)	100016951
25 ft (7.6 m)	100016952
50 ft (15.2 m)	100016953
<b>Cable for Capacitance Manometer, Type 626B/627D</b>	
10 ft (3.0 m)	100007555
25 ft (7.6 m)	100007556
50 ft (15.2 m)	100007557
Custom to 50 ft (15.2 m)	100007558
<b>Cable for Series 902 Transducer</b>	
10 ft (3.0 m)	100011869
25 ft (7.6 m)	100011870
50 ft (15.2 m)	100011871
Custom (maximum length 50 ft)	100011872
<b>Cable for Cold Cathode Sensor, Series 431</b>	
10 ft (3.0 m)	100016217
25 ft (7.6 m)	100016218
50 ft (15.2 m)	100016219
100 ft (30.5 m)	100016220
Custom to 300 ft (91.4 m)	100016221
<b>Cable for Cold Cathode Sensor, Series 423 I-MAG®</b>	
2 ft (0.6 m)	100016295
10 ft (3.0 m)	100016296
25 ft (7.6 m)	100016297
50 ft (15.2 m)	100016298
Custom to 300 ft (91.4 m)	100016299
<b>Cable for Hot Cathode, Mini BA Gauge</b>	
10 ft (3.0 m)	100011106
25 ft (7.6 m)	100011107
50 ft (15.2 m)	100011108
<b>Cable for Hot Cathode, Low Power Nude</b>	

10 ft (3.0 m)	100010909
25 ft (7.6 m)	100010910
50 ft (15.2 m)	100010911
<b>Cable for 317 Convection Pirani &amp; 345 Pirani Sensor</b>	
10 ft (3.0 m)	103170006SH
25 ft (7.6 m)	103170007SH
50 ft (15.2 m)	103170008SH
100 ft (30.5 m)	103170017SH
Custom to 500 ft (152.4 m)	103170009SH
<b>Cable for Mass flow controller (15 pin connector)</b>	
10 ft (3.0 m)	100016744
25 ft (7.6 m)	100016745
50 ft (15.2 m)	100016746
<b>Cable for Mass flow controller (9 pin connector)</b>	
10 ft (3.0 m)	100019087
25 ft (7.6 m)	100019088
50 ft (15.2 m)	100019089
<b>Cable for 148/248/154 solenoid valve</b>	
10 ft (3.0 m)	100018192
XX ft	100018191-XX
<b>Cable for 153/T3B throttle valve</b>	
10 ft (3.0 m)	100018191
XX ft	100019191-XX
<b>Cable for T3B</b>	
T3B to 946	1053451-001
Din Rail Power Supply	1053456-001
Desktop Power Supply	1053192-001
<b>Sensor, Series 431 Cold Cathode</b>	
KF 25	104310004
KF 40	104310001
2¾" CF	104310002
1" tube	104310003
8 VCR®-F (½")	104310005
<b>Sensor, Series 423 I-MAG® Cold Cathode</b>	
KF 25	104230004
KF 40	104230001
2¾" CF	104230002
1" tube	104230003
<b>Sensor, Hot Cathode MIG Gauge, Yr Coated Ir filament</b>	
1" OD tube	100011085
Mini CF	100011111
2¾" CF	100011112
KF 25	100011113
KF 40	100011114
KF 16	100011118
¾" OD tube	100011127
<b>Sensor, Hot Cathode, Low Power Nude</b>	
KF 40, W filament	100005987
2¾" CF, W filament	100005980
KF 40, Yr coated Ir filament	100006841
2¾" CF, Yr coated Ir filament	100006842
<b>Sensor, Convection Pirani, Shielded (317)</b>	
KF 16	103170010SH
KF25	103170027SH

1/8" NPT-M with 1/2" Compression Seal Option	103170011SH
8 VCR®-F (1/2")	103170012SH
4 VCR®-F (1/4")	103170029SH
1 1/3" CF (non-rotatable)	103170013SH
2 3/4" CF (non-rotatable)	103170014SH
Ø 15 mm x 30 mm Tubing	103170016SH
Ø 18 mm x 30 mm Tubing	103170018SH

**Sensor, Pirani (345)**

KF 16	103150010
1/8" NPT-M with 1/2" Compression Seal Option	103150011
8 VCR®-F (1/2")	103450012
1 1/3" CF (non-rotatable)	103450013
2 3/4" CF (non-rotatable)	103450014
KF25	103450015
Ø 15 mm x 30 mm Tubing	103450016
Ø 18 mm x 30 mm Tubing	103450018

**Sensor, Series 902 Piezo Transducer**

902 Transducer, NW16KF, RS485	902-1112
902 Transducer, 4 VCR®-F, RS485	902-1212
902 Transducer, 8 VCR®-F, RS485	902-1312
902 Transducer, NW16KF, RS232	902-1113
902 Transducer, 4 VCR®-F, RS232	902-1213
902 Transducer, 8 VCR®-F, RS232	902-1313
902 Transducer, NW16KF, 0-10V	902-1105
902 Transducer, 4 VCR®-F, 0-10V	902-1205
902 Transducer, 8 VCR®-F, 0-10V	902-1305

Please call the HPS® Products Customer Service Department of MKS Vacuum Products Group at 1-303-449-9861 or 1-800-345-1967 to order any of these parts or to receive catalogs for other MKS products.



# 12 APPENDIX

## 12.1 Hot Cathode Gauge Gas Correction Factors

Substance	Formula	Relative ionization Gas correction factor	Substance	Formula	Relative ionization Gas correction factor		
Acetaldehyde	C <sub>2</sub> H <sub>4</sub> O	2.6	Carbon disulfide	CS <sub>2</sub>	5.0		
Acetone	(CH <sub>3</sub> ) <sub>2</sub> CO	3.6			4.7		
		4.0			4.8		
Acetylene	C <sub>2</sub> H <sub>2</sub>	3.6	Carbon monoxide	CO	1.05		
		1.9			1.05		
Air		2.0	Carbon tetrachloride	CCl <sub>4</sub>	6.0		
		1.0			6.3		
Ammonia	NH <sub>3</sub>	0.98	Cesium	Cs	4.3		
		1.3			2.0		
		1.2			4.8		
iso-Amylene	Iso-C <sub>5</sub> H <sub>10</sub>	5.9	Chlorine	Cl <sub>2</sub>	0.68		
cyclo-Amylene	cyclo-C <sub>5</sub> H <sub>10</sub>	5.8			2.6		
Argon	Ar	1.3			1.6		
		1.1	Chlorobenzene	C <sub>6</sub> H <sub>5</sub> Cl	7.0		
		1.2			Chloroethane	C <sub>2</sub> H <sub>5</sub> Cl	4.0
		0.9			Chloroform	CHCl <sub>3</sub>	4.7
Benzene	C <sub>6</sub> H <sub>6</sub>	5.9		4.8			
		5.8		4.8			
		5.7	Chloromethane	CH <sub>3</sub> Cl	2.6		
		5.9			3.2		
		6.0			3.1		
Benzoic Acid	C <sub>6</sub> H <sub>5</sub> COOH	5.5	Cyanogen	(CN) <sub>2</sub>	2.8		
Bromine	Br	3.8			3.6		
Bromomethane	CH <sub>3</sub> Br	3.7			2.7		
n-Butane	n-C <sub>4</sub> H <sub>10</sub>	4.9	Cyclohexylene	C <sub>6</sub> H <sub>12</sub>	7.9		
		4.7			6.4		
Iso-Butane	iso-C <sub>4</sub> H <sub>10</sub>	4.6	Deuterium	D <sub>2</sub>	0.35		
		4.9			0.38		
Cadmium	Cd	2.3	Dichlorodifluoro- methane	CCl <sub>2</sub> F <sub>2</sub>	2.7		
		3.4			4.1		
Carbon dioxide	CO <sub>2</sub>	1.42	Dichloromethane	CH <sub>2</sub> Cl <sub>2</sub>	3.7		
		1.4	Dinitrobenzene	C <sub>6</sub> H <sub>4</sub> (NO <sub>2</sub> ) <sub>2</sub>	7.8		
		1.5				o-	
		1.5				m-	
		1.4				p-	

Ethane	$C_2H_6$	2.6	Iodomethane	$CH_3I$	4.2
		2.8	Isoamyl alcohol	$C_5H_{11}OH$	2.9
		2.5	Isobutylene	$C_4H_8$	3.6
Ethanol	$C_2H_5OH$	3.6	Krypton	Kr	1.9
		2.9			1.7
Ethyl acetate	$CH_3COOC_2H_5$	5.0			
Ethyl ether	$(C_2H_5)_2O$	5.1	Lithium	Li	1.9
		5.1	Mercury	Hg	3.6
Ethylene	$C_2H_4$	2.3	Methane	$CH_4$	1.4
		2.4			1.5
		2.2			1.6
		2.2 to 2.5			1.4 to 1.8
Ethylene oxide	$(CH_2)_2O$	2.5			1.5
Helium	He	0.18			1.5
		0.15	Methanol	$CH_3OH$	1.8
		0.13			1.9
		0.12	Methyl acetate	$CH_3COOCH_3$	4.0
Heptane	$C_7H_{16}$	8.6	Methyl ether	$(CH_3)_2O$	3.0
1,5-Hexadiene	$1,5-C_6H_{10}$	6.4			3.0
Cyclo-Hexadiene	Cy- $C_6H_{10}$	6.0	Naphthalene	$C_{10}H_8$	9.7
Hexane	$C_6H_{14}$	6.6	Neon	Ne	0.30
1-Hexane	$1-C_6H_{12}$	5.9			0.31
Cyclo-hexane	Cy- $C_6H_{10}$	6.4	Nitrobenzene	$C_6H_5NO_2$	7.2
Hydrogen	$H_2$	0.46	Nitrogen	$N_2$	1.0
		0.38	Nitrotoluene (o-,m-,p-)	$C_6H_4CH_3NO_2$	8.5
		0.41	Nitric oxide	NO	1.3
		0.45			1.2
		0.44			1.0
Hydrogen Bromide	HBr	2.0	Nitrous oxide	$N_2O$	1.5
Hydrogen chloride	HCl	1.5			1.7
		1.6			1.7
		2.0			1.3 to 2.1
		1.5	Oxygen	$O_2$	1.0
Hydrogen cyanide	HCN	1.5			1.1
		1.6			0.9
Hydrogen fluoride	HF	1.4			0.9
Hydrogen iodide	HI	3.1	n-Pentane	n- $C_5H_{12}$	6.2
Hydrogen sulfide	$H_2S$	2.2			6.0
		2.2			5.7
		2.3	Iso-Pentane	i- $C_5H_{12}$	6.0
		2.1	Neo-Pentane	$(CH_3)_4C$	5.7
Iodine	$I_2$	5.4	Phenol	$C_6H_5OH$	6.2

Phosphine	PH <sub>3</sub>	2.6	Sulfur dioxide	SO <sub>2</sub>	2.1
Potassium	K	3.6			2.3
Propane	C <sub>3</sub> H <sub>8</sub>	4.2	Sulfur hexafluoride	SF <sub>6</sub>	2.3
		3.7			2.8
		3.7 to 3.9	Toluene	C <sub>6</sub> H <sub>5</sub> CH <sub>3</sub>	6.8
		3.6	Trinitrobenzene	C <sub>6</sub> H <sub>3</sub> (NO <sub>2</sub> ) <sub>3</sub>	9.0
Propene oxide	C <sub>3</sub> H <sub>6</sub> O	3.9	Water	H <sub>2</sub> O	1.1
n-Propene	n-C <sub>3</sub> H <sub>6</sub>	3.3			1.0
		3.2 to 3.7			0.8
cyclo-Propene	cy-C <sub>3</sub> H <sub>6</sub>	3.6	Xenon	Xe	2.87
Rubidium	Rb	4.3			2.2
Silver perchlorate	AgClO <sub>4</sub>	3.6			2.4
Sodium	Na	3.0	o-Xylene	o-C <sub>6</sub> H <sub>4</sub> (CH <sub>3</sub> ) <sub>2</sub>	7.8
Stannic iodide	SnI <sub>4</sub>	6.7	p-Xylene	p-C <sub>6</sub> H <sub>4</sub> (CH <sub>3</sub> ) <sub>2</sub>	7.9

## 13.2 MFC Gas Conversion Factors for Selected Gases

Gas	Symbol	Cp Cal/g K)	Density g/l @ 0 °C	Conversion Factor
Air		0.240	1.293	1.00
Ammonia	NH <sub>3</sub>	0.492	0.760	0.73
Argon	Ar	0.1244	1.782	1.39
Arsine	AsH <sub>3</sub>	0.1167	3.478	0.67
Boron Trichloride	BCl <sub>3</sub>	0.1279	5.227	0.41
Bromine	Br <sub>2</sub>	0.0539	7.130	0.81
Carbon Dioxide	CO <sub>2</sub>	0.2016	1.964	0.70
Carbon Monoxide	CO	0.2488	1.250	1.00
Carbon Tetrachloride	CCl <sub>4</sub>	0.1655	6.86	0.31
Carbon Tetrafluoride (Freon 14)	CF <sub>4</sub>	0.1654	3.926	0.42
Chlorine	Cl <sub>2</sub>	0.1144	3.163	0.86
Chlorodifluoromethane (Freon 22)	CHClF <sub>2</sub>	0.1544	3.858	0.46
Chloropentafluoroethane (Freon 115)	C <sub>2</sub> ClF <sub>5</sub>	0.164	6.892	0.24
Chlorotrifluoromethane (Freon 13)	CClF <sub>3</sub>	0.153	4.660	0.38
Cyanogen	C <sub>2</sub> N <sub>2</sub>	0.2613	2.322	0.61
Deuterium	D <sub>2</sub>	1.722	0.1799	1.00
Diborane	B <sub>2</sub> H <sub>6</sub>	0.508	1.235	0.44
Dibromodifluoromethane	CBr <sub>2</sub> F <sub>2</sub>	0.15	9.362	0.19
Dichlorodifluoromethane (Freon 12)	CCl <sub>2</sub> F <sub>2</sub>	0.1432	5.395	0.35
Dichlorofluoromethane (Freon 21)	CHCl <sub>2</sub> F	0.140	4.592	0.42

Dichloromethylsilane	$(\text{CH}_3)_2\text{SiCl}_2$	0.1882	5.785	0.25
Dichlorosilane	$\text{SiH}_2\text{Cl}_2$	0.150	4.506	0.40
1,2-Dichlorotetrafluoroethane (Freon 114)	$\text{C}_2\text{Cl}_2\text{F}_4$	0.160	7.626	0.22
1,1-Difluoroethylene (Freon 1132A)	$\text{C}_2\text{H}_2\text{F}_2$	0.224	2.857	0.43
2,2-Dimethylpropane	$\text{C}_5\text{H}_{12}$	0.3914	3.219	0.22
Ethane	$\text{C}_2\text{H}_6$	0.4097	1.342	0.50
Fluorine	$\text{F}_2$	0.1873	1.695	0.98
Fluoroform (Freon 23)	$\text{CHF}_3$	0.176	3.127	0.50
Freon 11	$\text{CCl}_3\text{F}$	0.1357	6.129	0.33
Freon 12	$\text{CCl}_2\text{F}_2$	0.1432	5.395	0.35
Freon 13	$\text{CClF}_3$	0.153	4.660	0.38
Freon 13B1	$\text{CBrF}_3$	0.1113	6.644	0.37
Freon 14	$\text{CF}_4$	0.1654	3.926	0.42
Freon 21	$\text{CHCl}_2\text{F}$	0.140	4.592	0.42
Freon 22	$\text{CHClF}_2$	0.1544	3.858	0.46
Freon 23	$\text{CHF}_3$	0.176	3.127	0.50
Freon 113	$\text{C}_2\text{Cl}_2\text{F}_3$	0.161	8.360	0.20
Freon 114	$\text{C}_2\text{Cl}_2\text{F}_4$	0.160	7.626	0.22
Freon 115	$\text{C}_2\text{ClF}_5$	0.164	6.892	0.24
Freon 116	$\text{C}_2\text{F}_6$	0.1843	6.157	0.24
Freon C318	$\text{C}_4\text{F}_8$	0.1866	8.93	0.164
Freon 1132A	$\text{C}_2\text{H}_2\text{F}_2$	0.224	2.857	0.43
Helium	He	1.241	0.1786	1.45
Hexafluoroethane (Freon 116)	$\text{C}_2\text{F}_6$	0.1843	6.157	0.24
Hydrogen	$\text{H}_2$	3.419	0.0899	1.01
Hydrogen Bromide	HBr	0.0861	3.610	1.00
Hydrogen Chloride	HCl	0.1912	1.627	1.00
Hydrogen Fluoride	HF	0.3479	0.893	1.00
Isobutylene	$\text{C}_4\text{H}_8$	0.3701	2.503	0.29
Krypton	Kr	0.0593	3.739	1.543
Methane	$\text{CH}_4$	0.5328	0.715	0.72
Methyl Fluoride	$\text{CH}_3\text{F}$	0.3221	1.518	0.56
Molybdenum Hexafluoride	$\text{MoF}_6$	0.1373	9.366	0.21
Neon	Ne	0.246	0.900	1.46
Nitric Oxide	NO	0.2328	1.339	0.99
Nitrogen	$\text{N}_2$	0.2485	1.250	1.00
Nitrogen Dioxide	$\text{NO}_2$	0.1933	2.052	**
Nitrogen Trifluoride	$\text{NF}_3$	0.1797	3.168	0.48
Nitrous Oxide	$\text{N}_2\text{O}$	0.2088	1.964	0.71
Octafluorocyclobutane (Freon C318)	$\text{C}_4\text{F}_8$	0.1866	8.93	0.164
Oxygen	$\text{O}_2$	0.2193	1.427	0.993
Pentane	$\text{C}_5\text{H}_{12}$	0.398	3.219	0.21

Perfluoropropane	$C_3F_8$	0.194	8.388	0.17
Phosgene	$COCl_2$	0.1394	4.418	0.44
Phosphine	$PH_3$	0.2374	1.517	0.76
Propane	$C_3H_8$	0.3885	1.967	0.36
Propylene	$C_3H_6$	0.3541	1.877	0.41
Silane	$SiH_4$	0.3189	1.433	0.60
Silicon Tetrachloride	$SiCl_4$	0.1270	7.580	0.28
Silicon Tetrafluoride	$SiF_4$	0.1691	4.643	0.35
Sulfur Dioxide	$SO_2$	0.1488	2.858	0.69
Sulfur Hexafluoride	$SF_6$	0.1592	6.516	0.26
Trichlorofluoromethane (Freon 11)	$CCl_3F$	0.1357	6.129	0.33
Trichlorosilane	$SiHCl_3$	0.1380	6.043	0.33
1,1,2 Trichloro-1,2,2,-Trifluoroethane (Freon 113)	$C_2Cl_3F_3$	0.161	8.360	0.20
Tungsten Hexafluoride	$WF_6$	0.0810	13.28	0.25
Xenon	$Xe$	0.0378	5.858	1.32

\*\* Consult MKS Instruments

Note: Standard pressure is defined as 760 torr (mmHg). Standard temperature is defined as 0 °C.

# 13 Product Warranty

## Extent of the Warranty

MKS Instruments, Inc., Vacuum Products Group (MKS), warrants the HPS® Products Series 946 High Vacuum, Multi-Sensor System and its accessories to be free from defects in materials and workmanship for one (1) year from the date of shipment by MKS or authorized representative to the original purchaser (PURCHASER). Any product or parts of the product repaired or replaced by MKS under this warranty are warranted only for the remaining unexpired part of its one (1) year original warranty period. After expiration of the applicable warranty period, the PURCHASER shall be charged MKS' current prices for parts and labor, plus any transportation for any repairs or replacement.

**ALL EXPRESS AND IMPLIED WARRANTIES, INCLUDING THE IMPLIED WARRANTIES OF MERCHANTABILITY AND FITNESS FOR A PARTICULAR PURPOSE, ARE LIMITED TO THE WARRANTY PERIOD. NO WARRANTIES, EXPRESS OR IMPLIED, WILL APPLY AFTER THIS PERIOD.**

## Warranty Service

The obligations of MKS under this warranty shall be at its option: (1) to repair, replace, or adjust the product so that it meets applicable product specifications published by MKS or (2) to refund the purchase price.

## What Is Not Covered

The product is subject to above terms only if located in the country of the seller from whom the product was purchased. The above warranties do not apply to:

- I. Damages or malfunctions due to failure to provide reasonable and necessary maintenance in accordance with MKS operating instructions.
- II. Damages or malfunctions due to chemical or electrolytic influences or use of the product in working environments outside the specification.
- III. Fuses and all expendable items which by their nature or limited lifetime may not function for a year. If such items fail to give reasonable service for a reasonable period of time within the warranty period of the product; they will, at the option of MKS, be repaired or replaced.
- IV. Defects or damages caused by modifications and repairs effected by the original PURCHASER or third parties not authorized in the manual.

## Condition of Returned Products

MKS will not accept for repair, replacement, or credit any product which is asserted to be defective by the PURCHASER, or any product for which paid or unpaid service is desired, if the product is contaminated with potentially corrosive, reactive, harmful, or radioactive materials, gases, or chemicals.

When products are used with toxic chemicals, or in an atmosphere that is dangerous to the health of humans, or is environmentally unsafe, it is the responsibility of the PURCHASER to have the product cleaned by an independent agency skilled and approved in the handling and cleaning of contaminated materials before the product will be accepted by MKS for repair and/or replacement.

In the course of implementing this policy, MKS Customer Service Personnel may inquire of the PURCHASER whether the product has been contaminated with or exposed to potentially corrosive, reactive, harmful, or radioactive materials, gases, or chemicals when the PURCHASER requests a return authorization. Notwithstanding such inquiries, it is the responsibility of the PURCHASER to ensure that no products are returned to MKS which have been contaminated in the aforementioned manner.

## Other Rights and Remedies

- I. These remedies are exclusive. HPS SHALL NOT BE LIABLE FOR CONSEQUENTIAL DAMAGES, FOR ANTICIPATED OR LOST PROFITS, INCIDENTAL DAMAGES OR LOSS OF TIME, OR OTHER LOSSES INCURRED BY THE PURCHASER OR BY ANY THIRD PARTY IN CONNECTION WITH THE PRODUCT COVERED BY THIS WARRANTY, OR OTHERWISE. Some states do not allow exclusion or limitation of incidental or consequential damage or do not allow the limitation on how long an implied warranty lasts. If such laws apply, the limitations or exclusions expressed herein may not apply to PURCHASER.
- II. Unless otherwise explicitly agreed in writing, it is understood that these are the only written warranties given by HPS. Any statements made by any persons, including representatives of MKS, which are inconsistent or in conflict with the terms of the warranty shall not be binding on MKS unless reduced to writing and approved by an authorized officer of MKS.
- III. This warranty gives PURCHASER specific legal rights, and PURCHASER may also have other rights which vary from state to state.
- IV. For MKS products sold outside of the U.S., contact your MKS representative for warranty information and service.

## Warranty Performance

To obtain warranty satisfaction, contact the following: MKS Instruments, Inc., Vacuum Products Group, 5330 Sterling Drive, Boulder, CO 80301, USA, at phone number (303) 449-9861. You may be required to present proof of original purchase.