



115714-P1
Rev D, 3/99
Instruction Manual

MKS Type 153D and 1253D Throttle Valve Controllers



WARRANTY

Type 153D/1253D Equipment

MKS Instruments, Inc. (**MKS**) warrants that the equipment described above (the "equipment") manufactured by **MKS** shall be free from defects in materials and workmanship for a period of one year from date of shipment and will for a period of two years from the date of shipment, correctly perform all date-related operations, including without limitation accepting data entry, sequencing, sorting, comparing, and reporting, regardless of the date the operation is performed or the date involved in the operation, provided that, if the equipment exchanges data or is otherwise used with equipment, software, or other products of others, such products of others themselves correctly perform all date-related operations and store and transmit dates and date-related data in a format compatible with **MKS** equipment. THIS WARRANTY IS **MKS'** SOLE WARRANTY CONCERNING DATE-RELATED OPERATIONS.

For the period commencing with the date of shipment of this equipment and ending one year later in the case of defects in materials and workmanship, but two years later in the case of failure to comply with the date-related operations warranty, **MKS** will, at its option, either repair or replace any part which is defective in materials or workmanship or with respect to the date-related operations warranty without charge to the purchaser. The foregoing shall constitute the exclusive and sole remedy of the purchaser for any breach by **MKS** of this warranty.

The purchaser, before returning any equipment covered by this warranty, which is asserted to be defective by the purchaser, shall make specific written arrangements with respect to the responsibility for shipping the equipment and handling any other incidental charges with the **MKS** sales representative or distributor from which the equipment was purchased or, in the case of a direct purchase from **MKS**, with the **MKS** home office in Andover, Massachusetts, USA.

This warranty does not apply to any equipment which has not been installed and used in accordance with the specifications recommended by **MKS** for the proper and normal use of the equipment. **MKS** shall not be liable under any circumstances for indirect, special, consequential, or incidental damages in connection with, or arising out of, the sale, performance, or use of the equipment covered by this warranty.

MKS recommends that all **MKS** pressure and flow products be calibrated periodically (typically every 6 to 12 months) to ensure accurate readings. When a product is returned to **MKS** for this periodic re-calibration it is considered normal preventative maintenance not covered by any warranty.

THIS WARRANTY IS IN LIEU OF ALL OTHER RELEVANT WARRANTIES, EXPRESSED OR IMPLIED, INCLUDING THE IMPLIED WARRANTY OF MERCHANTABILITY AND THE IMPLIED WARRANTY OF FITNESS FOR A PARTICULAR PURPOSE, AND ANY WARRANTY AGAINST INFRINGEMENT OF ANY PATENT.

MKS Type 153D and 1253D Throttle Valve Controllers

Copyright © 1999 by MKS Instruments, Inc.

All rights reserved. No part of this work may be reproduced or transmitted in any form or by any means, electronic or mechanical, including photocopying and recording, or by any information storage or retrieval system, except as may be expressly permitted in writing by MKS Instruments, Inc.

Printed in the United States of America

Cluster Gauge™ is a trademark of MKS Instruments, Inc.

Firmware Version 1.1

Table of Contents

Valve Safety Information	1
Symbols Used in This Instruction Manual.....	1
Symbols Found on the Unit	2
Safety Procedures and Precautions	3
Informations relatives à la sécurité pour la valve.....	5
Symboles utilisés dans ce manuel d'utilisation	5
Symboles apparaissant sur l'unité.....	6
Mesures de sécurité et précautions	7
Sicherheitshinweise für das Ventil.....	9
In dieser Betriebsanleitung vorkommende Symbole.....	9
Erklärung der am Gerät angebrachten Symbole.....	10
Sicherheitsvorschriften und Vorsichtsmaßnahmen.....	11
Medidas de seguridad de la válvula	13
Símbolos usados en este manual de instrucciones.....	13
Símbolos hallados en la unidad	14
Procedimientos y precauciones de seguridad.....	15
Chapter One: General Information.....	17
Introduction	17
How This Manual Is Organized.....	18
Customer Support.....	18
Chapter Two: Installation	19
How To Unpack the 153/1253 Unit.....	19
Unpacking Checklist	19
Interface Cables	20
Interconnections for the 153 Unit	21
Interconnections for the 1253 Unit.....	24
Generic Shielded Cable Guidelines.....	25
Product Location and Requirements.....	26

153 Unit: Heated Valves	26
System Considerations.....	26
Size of the 253 Valve.....	26
Setup.....	26
Mounting the 153 Unit.....	26
Mounting the 1253 Unit.....	26
Chapter Three: Overview	27
General Information	27
Labels	28
Serial Number Label.....	28
Pump Label (153 units only).....	28
External Connectors and Controls on the 153 Unit	29
J1 - INPUT Connector	29
J2 - POWER Connector	31
Manual Switch.....	31
HOLD/NORMAL Switch	31
External Connectors and Controls on the 1253 Unit	32
J3 Connector - VALVE Connector.....	32
Manual Switch.....	33
Internal Controls on the 153/1253 Controller.....	34
Factory Settings	36
RS-232 Configuration.....	36
Control Parameters	37
Power-Down Constants	38
Valve Slippage Signal	39
Valve Slippage.....	39
Chapter Four: Operation	41
General Information	41
How To Learn the Valve with the 1253 Controller	42
How To Tune the 153/1253 Controller	43
How To Calibrate the 153/1253 Controller.....	44
How the 153/1253 Controller Handles the Calibration Voltages.....	45

How To Switch Between Normal and Reverse Modes.....	46
How To Communicate via RS-232	46
How To Connect to a PC.....	46
How To Change the Dipswitch Settings	47
How To Connect to the MKS PT-1	48
Standard Protocol	49
How To Reset the 153/1253 Controller	51
Portable Terminal (PT-1) Protocol.....	51
New Set Point Syntax.....	52
How To Connect the 153/1253 to the Type 146 Cluster Gauge™	52
Chapter Five: Maintenance.....	53
General Information.....	53
How To Clean the Unit	53
Appendix A: Product Specifications	55
Electrical Specifications.....	55
Performance Specifications	56
Physical Specifications	56
Environmental Specifications.....	56
Appendix B: Model Code Explanation	57
Model Code for the Type 153 Unit	57
Model Code for the Type 1253 Unit.....	60
Index.....	61

List of Figures and Tables

Figures

Figure 1: Piping and Cable Interconnections for the Type 153 Unit	21
Figure 2: Returned Leads Tied to System Ground	23
Figure 3: Piping and Cable Interconnections for the Type 1253 Unit	24
Figure 4: Serial Number Label	28
Figure 5: Pump Label.....	28
Figure 6: Top Panel of the 153 Unit	29
Figure 7: Front Panel of the 1253 Unit	32
Figure 8: Dipswitch Bank on the Motherboard	34
Figure 9: RS-232 Communication Cable (Null Modem).....	46

Tables

Table 1: Definition of Symbols Found on the Unit	2
Tableau 2: Définition des symboles apparaissant sur l'unité.....	6
Tabelle 3: Bedeutung der am Gerät angebrachten Symbole.....	10
Tabla 4: Definición de los símbolos hallados en la unidad.....	14
Table 5: Interface Cables	20
Table 6: Cables for the Type 153 Unit.....	21
Table 7: INPUT Connector (J1) Pinout.....	30
Table 8: POWER Connector (J2) Pinout.....	31
Table 9: VALVE Connector (J3) Pinout	33
Table 10: Explanation of the Dipswitch Settings	35
Table 11: Factory Settings for the RS-232 Communication Parameters	36
Table 12: Factory Settings for Control Parameters.....	37
Table 13: RS-232 Communications Settings.....	47
Table 14: Standard Protocol Commands.....	49
Table 15: Report Command Responses	50
Table 16: Operating Values Established By The “B” Command	50
Table 17: Dipswitch Settings for Portable Terminal Protocol.....	51

Valve Safety Information

Symbols Used in This Instruction Manual

Definitions of WARNING, CAUTION, and NOTE messages used throughout the manual.

Warning



The **WARNING** sign denotes a hazard to personnel. It calls attention to a procedure, practice, condition, or the like, which, if not correctly performed or adhered to, could result in injury to personnel.

Caution



The **CAUTION** sign denotes a hazard to equipment. It calls attention to an operating procedure, practice, or the like, which, if not correctly performed or adhered to, could result in damage to or destruction of all or part of the product.

Note



The **NOTE** sign denotes important information. It calls attention to a procedure, practice, condition, or the like, which is essential to highlight.

Symbols Found on the Unit

The following table describes symbols that may be found on the unit.















Definition of Symbols Found on the Unit			
			
On (Supply) IEC 417, No.5007	Off (Supply) IEC 417, No.5008	Earth (ground) IEC 417, No.5017	Protective earth (ground) IEC 417, No.5019
			
Frame or chassis IEC 417, No.5020	Equipotentiality IEC 417, No.5021	Direct current IEC 417, No.5031	Alternating current IEC 417, No.5032
			
Both direct and alternating current IEC 417, No.5033-a	Class II equipment IEC 417, No.5172-a	Three phase alternating current IEC 617-2 No.020206	
			
Caution, refer to accompanying documents ISO 3864, No.B.3.1	Caution, risk of electric shock ISO 3864, No.B.3.6	Caution, hot surface IEC 417, No.5041	

Table 1: Definition of Symbols Found on the Unit

Safety Procedures and Precautions

Observe the following general safety precautions during all phases of valve operation. Failure to comply with these precautions or with specific warnings elsewhere in this manual violates safety standards of intended use of the valve and may impair the protection provided by the equipment. MKS Instruments, Inc. assumes no liability for the customer's failure to comply with these requirements.

Warning



Moving parts in the valve create a risk of personal injury until the valve is securely incorporated into a system. To avoid injury, keep all bodily parts away from any valve opening.

1. Do not insert objects into openings where contact with moving parts is possible.
 2. Isolate the valve from any electrical or pneumatic power supply before handling the valve.
-

DO NOT SUBSTITUTE PARTS OR MODIFY VALVE

Do not install substitute parts or perform any unauthorized modification to the valve. Return the valve to an MKS Calibration and Service Center for service and repair to ensure that all safety features are maintained.

SERVICE BY QUALIFIED PERSONNEL ONLY

Operating personnel must not attempt component replacement and internal adjustments. Any service must be performed by qualified service personnel only.

USE CAUTION WHEN OPERATING WITH HAZARDOUS MATERIALS

If hazardous materials are used, observe the proper safety precautions, completely purge the valve when necessary, and ensure that the material used is compatible with the wetted materials in this product, including any sealing materials.

PURGE THE VALVE

After installing the unit, or before removing it from a system, purge the unit completely with a clean, dry gas to eliminate all traces of the previously used flow material.

USE PROPER PROCEDURES WHEN PURGING

This valve must be purged under a ventilation hood, and gloves must be worn for protection.

DO NOT OPERATE IN AN EXPLOSIVE ENVIRONMENT

To avoid explosion, do not operate this product in an explosive environment unless it has been specifically certified for such operation.

USE PROPER FITTINGS AND TIGHTENING PROCEDURES

All valve fittings must be consistent with valve specifications, and compatible with the intended use of the valve. Assemble and tighten fittings according to manufacturer's directions.

CHECK FOR LEAK-TIGHT FITTINGS

Carefully check all vacuum component connections to ensure leak-tight installation.

OPERATE AT SAFE INLET PRESSURES

Never operate the valve at pressures higher than the rated maximum pressure (refer to the product specifications for the maximum allowable pressure).

INSTALL A SUITABLE BURST DISC

When operating from a pressurized gas source, install a suitable burst disc in the vacuum system to prevent system explosion should the system pressure rise.

KEEP THE UNIT FREE OF CONTAMINANTS

Do not allow contaminants to enter the unit before or during use. Contamination such as dust, dirt, lint, glass chips, and metal chips may permanently damage the unit or contaminate the process.

KEEP AWAY FROM VALVE OPENING

Keep fingers, other body parts, and other materials away from the valve opening when the valve is in operation.

Informations relatives à la sécurité pour la valve

Symboles utilisés dans ce manuel d'utilisation

Définitions des indications AVERTISSEMENT, ATTENTION, et REMARQUE utilisées dans ce manuel.

Avertissement



L'indication **AVERTISSEMENT** signale un danger pour le personnel. Elle attire l'attention sur une procédure, une pratique, une condition, ou toute autre situation présentant un risque d'accident pour le personnel, en cas d'exécution incorrecte ou de non respect des consignes.

Attention



L'indication **ATTENTION** signale un danger pour l'appareil. Elle attire l'attention sur une procédure d'exploitation, une pratique, ou toute autre situation, présentant un risque d'endommagement ou de destruction d'une partie ou de la totalité de l'appareil, en cas d'exécution incorrecte ou de non respect des consignes.

Remarque



L'indication **REMARQUE** signale une information importante. Elle attire l'attention sur une procédure, une pratique, une condition, ou toute autre situation, présentant un intérêt particulier.

Symboles apparaissant sur l'unité

Le tableau suivant décrit les symboles pouvant apparaître sur l'unité.















Définition des symboles apparaissant sur l'unité			
			
Marche (sous tension) IEC 417, No.5007	Arrêt (hors tension) IEC 417, No.5008	Terre (masse) IEC 417, No.5017	Terre de protection (masse) IEC 417, No.5019
			
Masse IEC 417, No.5020	Equipotentialité IEC 417, No.5021	Courant continu IEC 417, No.5031	Courant alternatif IEC 417, No.5032
			
Courant continu et alternatif IEC 417, No.5033-a	Matériel de classe II IEC 417, No.5172-a	Courant alternatif triphase IEC 617-2, No.020206	
			
Attention : se reporter à la documentation ISO 3864, No.B.3.1	Attention : risque de choc électrique ISO 3864, No.B.3.6	Attention : surface brûlante IEC 417, No.5041	

Tableau 2: Définition des symboles apparaissant sur l'unité

Mesures de sécurité et précautions

Prendre les précautions générales de sécurité suivantes pendant toutes les phases d'exploitation de la valve. Le non respect de ces précautions ou des avertissements contenus dans ce manuel constitue une violation des normes de sécurité relatives à l'utilisation de la valve et peut diminuer la protection fournie par l'appareil. MKS Instruments, Inc. n'assume aucune responsabilité concernant le non respect des consignes par les clients.

Avertissement



Les pièces mobiles de la valve peuvent être une cause d'accident tant que la valve n'est pas solidement incorporée dans un système. Pour éviter tout accident, tenir toute partie du corps à distance de toute ouverture de la valve.

- 1. Ne pas insérer des objets dans les ouvertures où le contact avec des pièces mobiles est possible.**
 - 2. Isoler la valve de toute source d'alimentation électrique ou pneumatique pendant la manipulation de la valve.**
-

PAS DE SUBSTITUTION DE PIÈCES OU DE MODIFICATION DE LA VALVE

Ne pas installer des pièces de substitution ou effectuer des modifications non autorisées sur la valve. Renvoyer la valve à un centre de service et de calibrage MKS pour tout dépannage ou réparation afin de garantir l'intégrité des dispositifs de sécurité.

DÉPANNAGE UNIQUEMENT PAR DU PERSONNEL QUALIFIÉ

Le personnel d'exploitation ne doit pas essayer de remplacer des composants ou de faire des réglages internes. Tout dépannage doit être uniquement effectué par du personnel qualifié.

PRÉCAUTION EN CAS D'UTILISATION AVEC DES PRODUITS DANGEREUX

Si des produits dangereux sont utilisés, prendre les mesures de précaution appropriées, purger complètement la valve quand cela est nécessaire, et s'assurer que les produits utilisés sont compatibles avec les composants liquides de l'appareil, y compris les matériaux d'étanchéité.

PURGE DE LA VALVE

Après l'installation de l'unité, ou avant son enlèvement d'un système, purger l'unité complètement avec un gaz propre et sec afin d'éliminer toute trace du produit de flux utilisé précédemment.

UTILISATION DES PROCÉDURES APPROPRIÉES POUR LA PURGE

Cette valve doit être purgée sous une hotte de ventilation, et il faut porter des gants de protection.

PAS D'EXPLOITATION DANS UN ENVIRONNEMENT EXPLOSIF

Pour éviter toute explosion, ne pas utiliser cet appareil dans un environnement explosif, sauf en cas d'homologation spécifique pour une telle exploitation.

UTILISATION D'ÉQUIPEMENTS APPROPRIÉS ET PROCÉDURES DE SERRAGE

Tous les équipements de la valve doivent être cohérents avec ses spécifications, et compatibles avec l'utilisation prévue de la valve. Assembler et serrer les équipements conformément aux directives du fabricant.

VÉRIFICATION DE L'ÉTANCHÉITÉ DES CONNEXIONS

Vérifier attentivement toutes les connexions des composants pour le vide afin de garantir l'étanchéité de l'installation.

EXPLOITATION AVEC DES PRESSIONS D'ENTRÉE NON DANGEREUSES

Ne jamais utiliser la valve avec des pressions supérieures à la pression nominale maximum (se reporter aux spécifications de l'unité pour la pression maximum admissible).

INSTALLATION D'UN DISQUE D'ÉCHAPPEMENT ADAPTÉ

En cas d'exploitation avec une source de gaz pressurisé, installer un disque d'échappement adapté dans le système à vide afin d'éviter une explosion du système en cas d'augmentation de la pression.

MAINTIEN DE L'UNITÉ À L'ABRI DES CONTAMINATIONS

Ne pas laisser des produits contaminants pénétrer dans l'unité avant ou pendant l'utilisation. Des produits contaminants tels que des poussières et des fragments de tissu, de glace et de métal peuvent endommager l'unité d'une manière permanente ou contaminer le processus.

PRÉCAUTION AVEC L'OUVERTURE DE LA VALVE

Éviter tout contact des mains, toute autre partie du corps, ou tout autre matériel avec l'ouverture de la valve quand celle-ci est en fonctionnement.

Sicherheitshinweise für das Ventil

In dieser Betriebsanleitung vorkommende Symbole

Bedeutung der mit WARNUNG!, VORSICHT! und HINWEIS gekennzeichneten Absätze in dieser Betriebsanleitung.

Warnung!



Das Symbol **WARNUNG!** weist auf eine Gefahr für das Bedienpersonal hin. Es macht auf einen Arbeitsablauf, eine Arbeitsweise, einen Zustand oder eine sonstige Gegebenheit aufmerksam, deren unsachgemäße Ausführung bzw. ungenügende Berücksichtigung zu Verletzungen führen kann.

Vorsicht!



Das Symbol **VORSICHT!** weist auf eine Gefahr für das Gerät hin. Es macht auf einen Bedienungsablauf, eine Arbeitsweise oder eine sonstige Gegebenheit aufmerksam, deren unsachgemäße Ausführung bzw. ungenügende Berücksichtigung zu einer Beschädigung oder Zerstörung des Gerätes oder von Teilen des Gerätes führen kann.

Hinweis



Das Symbol **HINWEIS** macht auf wichtige Informationen bezüglich eines Arbeitsablaufs, einer Arbeitsweise, eines Zustands oder einer sonstige Gegebenheit aufmerksam.

Erklärung der am Gerät angebrachten Symbole

Nachstehender Tabelle sind die Bedeutungen der Symbole zu entnehmen, die am Gerät angebracht sein können.















Bedeutung der am Gerät angebrachten Symbole			
			
Ein (Netz) IEC 417, No.5007	Aus (Netz) IEC 417, No.5008	Erde IEC 417, No.5017	Schutzerdung IEC 417, No.5019
			
Rahmen, Chassis IEC 417, No.5020	Aquipotential- anschluß IEC 417, No.5021	Gleichstrom IEC 417, No.5031	Wechselstrom IEC 417, No.5032
			
Gleichstrom und Wechselstrom IEC 417, No.5033-a	Geräteklasse II IEC 417, No.5172-a	Drehstrom IEC 617-2, No.020206	
			
Vorsicht! Bitte Begleitdokumente lesen! ISO 3864, No.B.3.1	Vorsicht! Stromschlaggefahr! ISO 3864, No.B.3.6	Vorsicht! Heiße Oberfläche! IEC 417, No.5041	

Tabelle 3: Bedeutung der am Gerät angebrachten Symbole

Sicherheitsvorschriften und Vorsichtsmaßnahmen

Folgende allgemeine Sicherheitsvorschriften sind während allen Betriebsphasen dieses Ventils zu befolgen. Eine Mißachtung der Sicherheitsvorschriften und sonstiger Warnhinweise in dieser Betriebsanleitung verletzt die für dieses Ventil und seine Bedienung geltenden Sicherheits-standards, und kann die eingebauten Schutzvorrichtungen wirkungslos machen. MKS Instruments, Inc. haftet nicht für Mißachtung dieser Sicherheitsvorschriften seitens des Kunden.

Warnung!



Solange das Ventil nicht fest in ein System eingebaut ist, besteht Verletzungsgefahr aufgrund von beweglichen Teilen. Daher Finger und andere Körperteile unbedingt von allen Ventilöffnungen fernhalten

- 1. Niemals Fremdkörper in Öffnungen einführen, in denen ein Kontakt mit beweglichen Teilen möglich ist.**
 - 2. Das Ventil vor dem Hantieren stets von allen elektrischen und pneumatischen Kraftquellen trennen.**
-

Niemals Teile austauschen oder Änderungen am Ventil vornehmen!

Ersetzen Sie keine Teile mit baugleichen oder ähnlichen Teilen, und nehmen Sie keine eigenmächtigen Änderungen am Ventil vor. Schicken Sie das Ventil zwecks Wartung und Reparatur an den MKS-Kalibrierungs- und -Kundendienst ein. Nur so wird sichergestellt, daß alle Schutzvorrichtungen voll funktionsfähig bleiben.

Wartung nur durch qualifizierte Fachleute!

Das Auswechseln von Komponenten und das Vornehmen von internen Einstellungen darf nur von qualifizierten Fachleuten durchgeführt werden, niemals vom Bedienpersonal.

Vorsicht beim Arbeiten mit gefährlichen Stoffen!

Wenn gefährliche Stoffe verwendet werden, muß der Bediener die entsprechenden Sicherheitsvorschriften genauestens einhalten, das Ventil, falls erforderlich, vollständig ausblasen, sowie sicherstellen, daß der Gefahrstoff die von ihm benetzten, im Ventil verwendeten Materialien, insbesondere Dichtungen, nicht angreift.

Ausblasen des Ventils

Nach dem Installieren oder vor dem Ausbau aus einem System muß das Ventil unter Einsatz eines reinen Trockengases vollständig ausgeblasen werden, um alle Rückstände des Vorgängermediums zu entfernen.

Anweisungen zum Ausblasen des Ventils

Das Ventil darf nur unter einer Ablufthaube ausgeblasen werden. Schutzhandschuhe sind zu tragen.

Nicht zusammen mit explosiven Stoffen, Gasen oder Dämpfen benutzen!

Um der Gefahr einer Explosion vorzubeugen, darf dieses Produkt niemals zusammen mit explosiven Stoffe aller Art eingesetzt werden, sofern es nicht ausdrücklich für diesen Zweck zugelassen ist.

Anweisungen zum Installieren der Armaturen

Alle Ventilanschlußstücke und Armaturenteile müssen mit den Ventilspezifikationen übereinstimmen, und mit dem geplanten Einsatz des Ventils kompatibel sein. Der Einbau, insbesondere das Anziehen und Abdichten, muß gemäß den Anweisungen des Herstellers vorgenommen werden.

Ventil auf Undichtigkeiten prüfen!

Überprüfen Sie sorgfältig alle Verbindungen auf undichte Stellen.

Nur unter zulässigen Anschlußdrücken betreiben!

Betreiben Sie das Ventil niemals unter Drücken, die den maximal zulässigen Druck (siehe Produktspezifikationen) übersteigen.

Geeignete Berstscheibe installieren!

Wenn mit einer unter Druck stehenden Gasquelle gearbeitet wird, sollte eine geeignete Berstscheibe in das Vakuumsystem installiert werden, um eine Explosionsgefahr aufgrund von steigendem Systemdruck zu vermeiden.

Verunreinigungen vermeiden!

Stellen Sie sicher, daß Verunreinigungen jeglicher Art weder vor dem Einsatz noch während des Betriebs in das Innere gelangen können. Staub- und Schmutzpartikel, Glassplitter oder Metallspäne können das Produkt dauerhaft beschädigen oder Prozeß und Meßwerte verfälschen.



Hände weg von der Ventilöffnung!

Körperteile, insbesondere Finger, sowie Fremdobjekte während des Betriebes von der Ventilöffnung fernhalten.

Medidas de seguridad de la válvula

Símbolos usados en este manual de instrucciones

Definiciones de los mensajes de advertencia, precaución y de las notas usados en el manual.

Advertencia		El símbolo de advertencia indica la posibilidad de que se produzcan daños personales. Pone de relieve un procedimiento, práctica, estado, etc. que en caso de no realizarse u observarse correctamente puede causar daños personales.
Precaución		El símbolo de precaución indica la posibilidad de producir daños al equipo. Pone de relieve un procedimiento operativo, práctica, estado, etc. que en caso de no realizarse u observarse correctamente puede causar daños o la destrucción total o parcial del equipo.
Nota		El símbolo de notas indica información de importancia. Este símbolo pone de relieve un procedimiento, práctica o condición cuyo conocimiento es esencial destacar.

Símbolos hallados en la unidad

La tabla siguiente contiene los símbolos que puede hallar en la unidad.















Definición de los símbolos hallados en la unidad			
			
Encendido (alimentación eléctrica) IEC 417, N° 5007	Apagado (alimentación eléctrica) IEC 417, N° 5008	Puesta a tierra IEC 417, N° 5017	Protección a tierra IEC 417, N° 5019
			
Caja o chasis IEC 417, N° 5020	Equipotencialidad IEC 417, N° 5021	Corriente continua IEC 417, N° 5031	Corriente alterna IEC 417, N° 5032
			
Corriente continua y alterna IEC 417, N° 5033-a	Equipo de clase II IEC 417, N° 5172-a	Corriente alterna trifásica IEC 617-2, N° 020206	
			
Precaución. Consulte los documentos adjuntos ISO 3864, N° B.3.1	Precaución. Riesgo de descarga eléctrica ISO 3864, N° B.3.6	Precaución. Superficie caliente IEC 417, N° 5041	

Tabla 4: Definición de los símbolos hallados en la unidad

Procedimientos y precauciones de seguridad

Las precauciones generales de seguridad descritas a continuación deben observarse durante todas las etapas de funcionamiento de la válvula. La falta de cumplimiento de dichas precauciones o de las advertencias específicas a las que se hace referencia en el manual, constituye una violación de las normas de seguridad establecidas para el uso previsto de la válvula y podría anular la protección proporcionada por el equipo. Si el cliente no cumple dichas precauciones y advertencias, MKS Instruments, Inc. no asume responsabilidad legal alguna.

Advertencia



Hasta que la válvula sea incorporada en forma segura al sistema, las piezas en movimiento presentes en la misma pueden causar daños personales. Para evitarlo, mantenga todo el cuerpo alejado de toda abertura de válvula.

- 1. No introduzca objetos que puedan entrar en contacto con piezas en movimiento por las aberturas.**
 - 2. Antes de tocar la válvula, aíselela de toda fuente de alimentación neumática o eléctrica.**
-

NO UTILICE PIEZAS NO ORIGINALES O MODIFIQUE LA VÁLVULA

No instale piezas que no sean originales o modifique la válvula sin autorización. Para asegurar el correcto funcionamiento de todos los dispositivos de seguridad, envíe la válvula al Centro de servicio y calibración de MKS toda vez que sea necesario efectuar reparaciones o tareas de mantenimiento.

LAS REPARACIONES DEBEN SER EFECTUADAS ÚNICAMENTE POR TÉCNICOS AUTORIZADOS

Los operarios no deben intentar reemplazar los componentes o realizar tareas de ajuste en el interior. Las tareas de mantenimiento o reparación deben ser realizadas únicamente por personal autorizado.

TENGA CUIDADO CUANDO TRABAJE CON MATERIALES TÓXICOS

Cuando se utilicen materiales tóxicos, los operarios deberán cumplir las medidas de seguridad correspondientes, purgar totalmente la válvula cuando sea necesario y comprobar que el material utilizado sea compatible con los materiales humedecidos del instrumento e inclusive, con los materiales de sellado.

PURGUE LA VÁLVULA

Una vez instalada la unidad o antes de retirarla del sistema, purgue completamente la unidad con gas limpio y seco para eliminar todo resto de la sustancia líquida empleada anteriormente.

USE PROCEDIMIENTOS ADECUADOS PARA REALIZAR LA PURGA

La válvula debe purgarse debajo de una campana de ventilación y deben utilizarse guantes protectores.

NO HAGA FUNCIONAR LA VÁLVULA EN UN AMBIENTE CON RIESGO DE EXPLOSIONES

Para evitar que se produzcan explosiones, no haga funcionar este producto en un ambiente con riesgo de explosiones, excepto cuando el mismo haya sido certificado específicamente para tal uso.

USE ACCESORIOS ADECUADOS Y REALICE CORRECTAMENTE LOS PROCEDIMIENTOS DE AJUSTE

Todos los accesorios de la válvula deben cumplir las especificaciones de la misma y ser compatibles con el uso que se debe dar a la válvula. Arme y ajuste los accesorios de acuerdo con las instrucciones del fabricante.

COMPRUEBE QUE LAS CONEXIONES SEAN A PRUEBA DE FUGAS

Inspeccione cuidadosamente las conexiones de los componentes de vacío para comprobar que hayan sido instalados a prueba de fugas.

HAGA FUNCIONAR LA VÁLVULA CON PRESIONES DE ENTRADA SEGURAS

No haga funcionar nunca la válvula con presiones superiores a la máxima presión nominal (en las especificaciones del instrumento hallará la presión máxima permitida).

INSTALE UNA CÁPSULA DE SEGURIDAD ADECUADA

Cuando el instrumento funcione con una fuente de gas presurizado, instale una cápsula de seguridad adecuada en el sistema de vacío para evitar que se produzcan explosiones cuando suba la presión del sistema.

MANTENGA LA UNIDAD LIBRE DE CONTAMINANTES

No permita el ingreso de contaminantes en la unidad antes o durante su uso. Los productos contaminantes tales como polvo, suciedad, pelusa, lascas de vidrio o virutas de metal pueden dañar irreparablemente la unidad o contaminar el proceso.

MANTÉNGASE ALEJADO DE LA ABERTURA DE LA VÁLVULA

Cuando la válvula esté funcionando, mantenga los dedos, otras partes del cuerpo y otros materiales alejados de la abertura.

Chapter One: General Information

Introduction

The MKS Type 153D and Type 1253D “Smart” Throttle Valve Controllers are designed for use in downstream pressure control applications. Both units work with the Type 253 valve and consist of the same electronics but differ in packaging. The 153 unit includes a 253 valve (built into it), a microprocessor, RS-232 communication connections, and driver circuits. The driver circuits eliminate the need for a separate controller box. The 1253 unit uses the same electronics as the 153 unit, however, the 253 valve is not enclosed in the unit. This allows you to mount a 253 valve separately from the controller box.

The 153/1253 controller contains a digital pressure/position control algorithm that directs the 253 valve to the proper position for either pressure or position control. The pressure or position set point may be an external voltage applied to the input connector, or sent as an RS-232 message. The 153/1253 unit reads the pressure signal used for control applications directly from a pressure transducer.

Power for the 153/1253 unit can be a *single* DC supply of +15 to +30 Volts. You can use a +15 VDC, +24 VDC, or +28 VDC supply. The units require approximately 5 Watts of power.

Note

Use a ± 15 V supply to power the 153/1253 unit if you plan to power transducers from the 153/1253 unit.

When the controller is turned off, or experiences an unexpected power loss, all calibration constants and the last valve position are saved in non-volatile memory. Therefore, when you repower the unit, it will be calibrated and ready for operation.

A switch on the front of the controller allows for off-line operation of the valve for troubleshooting. Switches inside the controller allow you to select:

- Baud Rate (1200 or 9600)
- Parity (Odd, Even)
- Select Analog or Digital Set Point Input
- Communications Protocol (Standard or Portable Terminal)

How This Manual Is Organized

This manual is designed to provide instructions on how to set up and install a Type 153 or Type 1253 unit.

Before installing your Type 153/1253 unit in a system and/or operating it, carefully read and familiarize yourself with all precautionary notes in the *Safety Messages and Procedures* section at the front of this manual. In addition, observe and obey all WARNING and CAUTION notes provided throughout the manual.

Chapter One, *General Information*, this chapter, introduces the product and describes the organization of the manual.

Chapter Two, *Installation*, explains the environmental requirements and describes how to mount the unit in your system.

Chapter Three, *Overview*, gives a brief description of each unit and its functionality.

Chapter Four, *Operation*, describes how to use the Type 153/1253 unit and explains all the functions and features.

Chapter Five, *Maintenance*, lists any maintenance required to keep the instrument in good working condition.

Appendix A, *Product Specifications*, lists the specifications of both units.

Appendix B, *Model Code Explanation*, describes the instrument's ordering code.

Customer Support

Standard maintenance and repair services are available at all of our regional MKS Calibration and Service Centers, listed on the back cover. In addition, MKS accepts the instruments of other manufacturers for recalibration using the Primary and Transfer Standard calibration equipment located at all of our regional service centers. Should any difficulties arise in the use of your Type 153 or 1253 instrument, or to obtain information about companion products MKS offers, contact any authorized MKS Calibration and Service Center. If it is necessary to return the instrument to MKS, please obtain an ERA Number (Equipment Return Authorization Number) from the MKS Calibration and Service Center before shipping. The ERA Number expedites handling and ensures proper servicing of your instrument.

Please refer to the inside of the back cover of this manual for a list of MKS Calibration and Service Centers.

Warning



All returns to MKS Instruments must be free of harmful, corrosive, radioactive, or toxic materials.

Chapter Two: Installation

How To Unpack the 153/1253 Unit

MKS has carefully packed the Type 153/1253 unit so that it will reach you in perfect operating order. Upon receiving the unit, however, you should check for defects, cracks, broken connectors, etc., to be certain that damage has not occurred during shipment.

If you find any damage, notify your carrier and MKS immediately. If it is necessary to return the unit to MKS, obtain an ERA Number (Equipment Return Authorization Number) from the MKS Service Center before shipping. Please refer to the inside of the back cover of this manual for a list of MKS Calibration and Service Centers.

Do not discard the protective plastic caps that are placed over the valve ports for shipment. Leave the protective caps on the valve until it is installed in the system and replace the caps when you remove the valve from the system.

Unpacking Checklist

Standard Equipment:

- 153D/1253D Unit
- Power cord

Optional Equipment:

- Electrical Connector Accessories Kit, 153D-K1 or 1253D-K1 (contains a mate for the electrical connector should you choose to make your own cable)

Interface Cables

As of January 1, 1996, most products shipped to the European Community must comply with the EMC Directive 89/336/EEC, which covers radio frequency emissions and immunity tests. In addition, as of January 1, 1997, some products shipped to the European Community must also comply with the Product Safety Directive 92/59/EEC and Low Voltage Directive 73/23/EEC, which cover general safety practices for design and workmanship. MKS products that meet these requirements are identified by application of the CE Mark.

To ensure compliance with EMC Directive 89/336/EEC, an overall metal braided shielded cable, properly grounded at both ends, is required during use. No additional installation requirements are necessary to ensure compliance with Directives 92/59/EEC and 73/23/EEC.

Note



1. An overall metal braided, shielded cable, properly grounded at both ends, is required during use to meet CE specifications.
2. To order an overall metal braided shielded cable, add an “S” after the cable type designation. For example, to order a cable to connect a 153 unit to a 122 unit, use part number CB153-8-XX, where XX designates the cable length; for a braided, shielded cable use part number CB153S-8-XX.

Interface Cables		
To Connect the 153 Unit to . . .	Use the MKS Cable . . .	
	Standard	Shielded
122	CB153-8	CB153S-8
127	CB153-7	CB153S-7
270	CB153-6	CB153S-6
To Connect the 1253 Unit to . . .	Use the MKS Cable . . .	
	Standard	Shielded
260 PS	CB153-1-XX	CB153S-1-XX
253 Valve	CB652-2-XX	CB652S-2-XX
xx indicates the cable length, in feet; standard length is 10 ft		

Table 5: Interface Cables

Interconnections for the 153 Unit

Figure 1 shows a typical set up for the 153 unit.

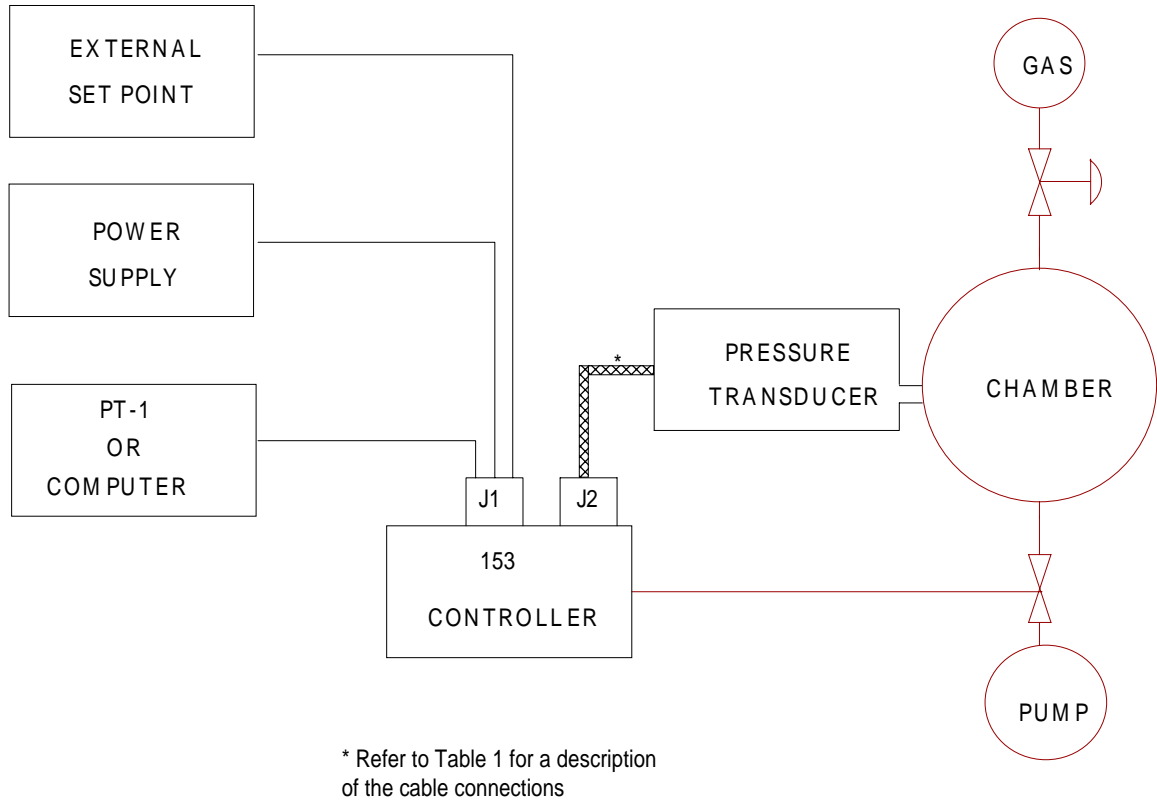

Figure 1: Piping and Cable Interconnections for the Type 153 Unit

Cables For the Type 153 Unit		
Cable To:	For	Cable Number
122	Input and Power	CB153-8
127	Input and Power	CB153-7
270 B/C	Input	CB153-6

Table 6: Cables for the Type 153 Unit

The 253 valve, enclosed in the 153 unit, requires +15 to +30 Volts. If you need to power a pressure transducer, you must supply ± 15 VDC to the 153 unit. The 153 unit uses the +15 Volts and sends the ± 15 Volts on to the pressure transducer. Both connectors J1 & J2 provide connections for ± 15 Volts and the pressure signal. The system shown in Figure 1, page 21, receives ± 15 Volts through the INPUT connector (J1) and interfaces with the pressure transducer through the POWER connector (J2). Table 6, page 21, lists the cables used to interface with various pressure transducers.

The 153 controller can receive a set point signal from either an external voltage source or an RS-232 signal. In either case, the INPUT connector (which incorporates the RS-232 communications) acts as the interface. Figure 1, page 21, shows an external voltage source connected as the set point signal.

The pressure and set point inputs to the 153 controller are both differential inputs that are not internally referenced to ground. Tie the returns to the system ground at a single point. Figure 2, page 23, illustrates this type of grounding.

Note

Not grounding the set point return or the pressure return (floating) can induce noise into the signals.

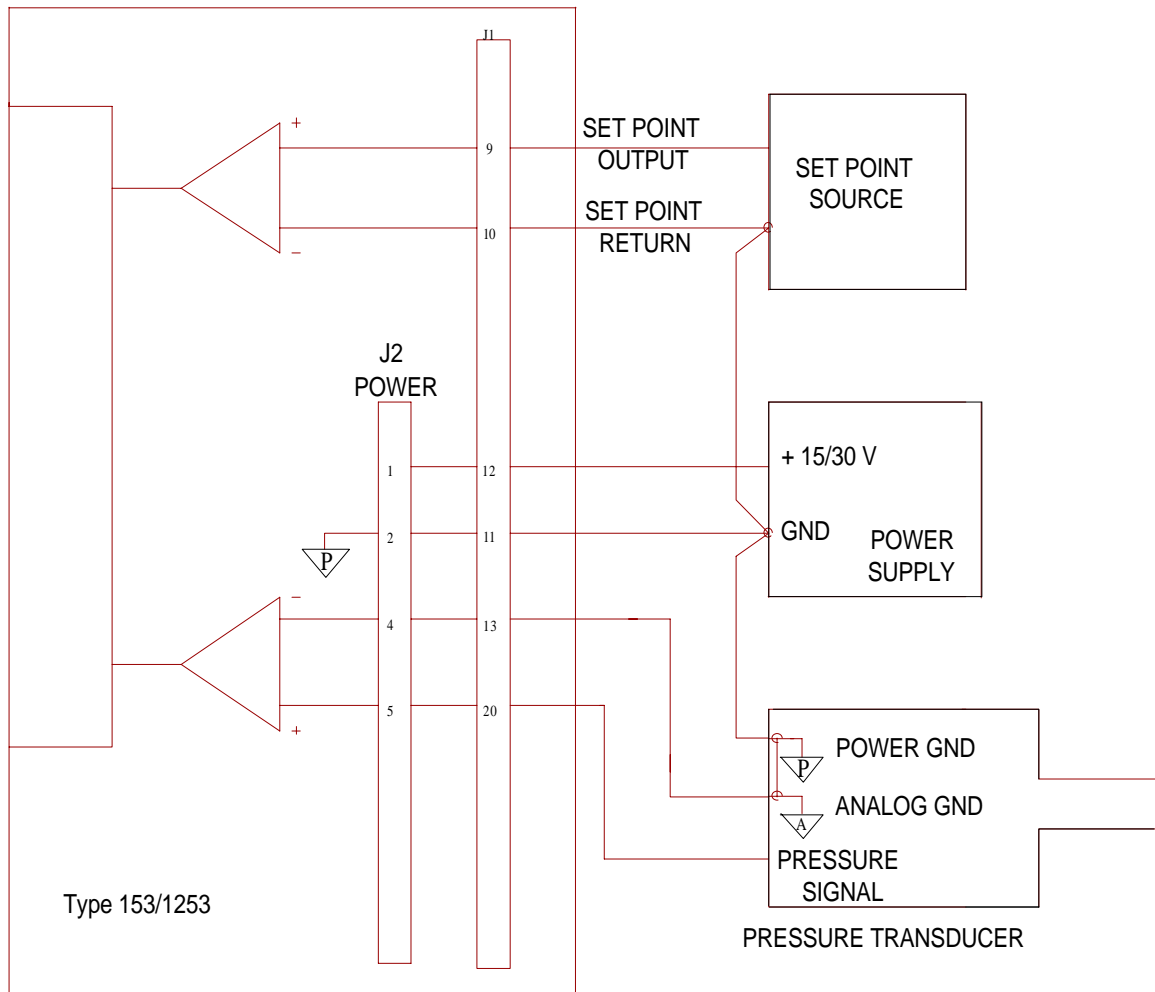

The Type 153 and 1253 units use true differential inputs for the pressure and set point input signals. You must connect the return leads to the power supply ground at a single point. Grounding at multiple points will produce ground loops and IR drops which will degrade performance.

Figure 2: Returned Leads Tied to System Ground

Interconnections for the 1253 Unit

The 1253 unit requires +15 to +30 Volts. If you need to power a pressure transducer through a 1253 unit, you must supply ± 15 VDC to the 1253 unit. The 1253 unit uses the +15 Volts and sends the ± 15 Volts on to the pressure transducer through the INPUT connector (J1). Figure 3 shows the ± 15 Volts being supplied from the MKS 260PS through a CB153-1 cable to the 1253 unit. The pressure transducer power and pressure signal connections are made through J1.

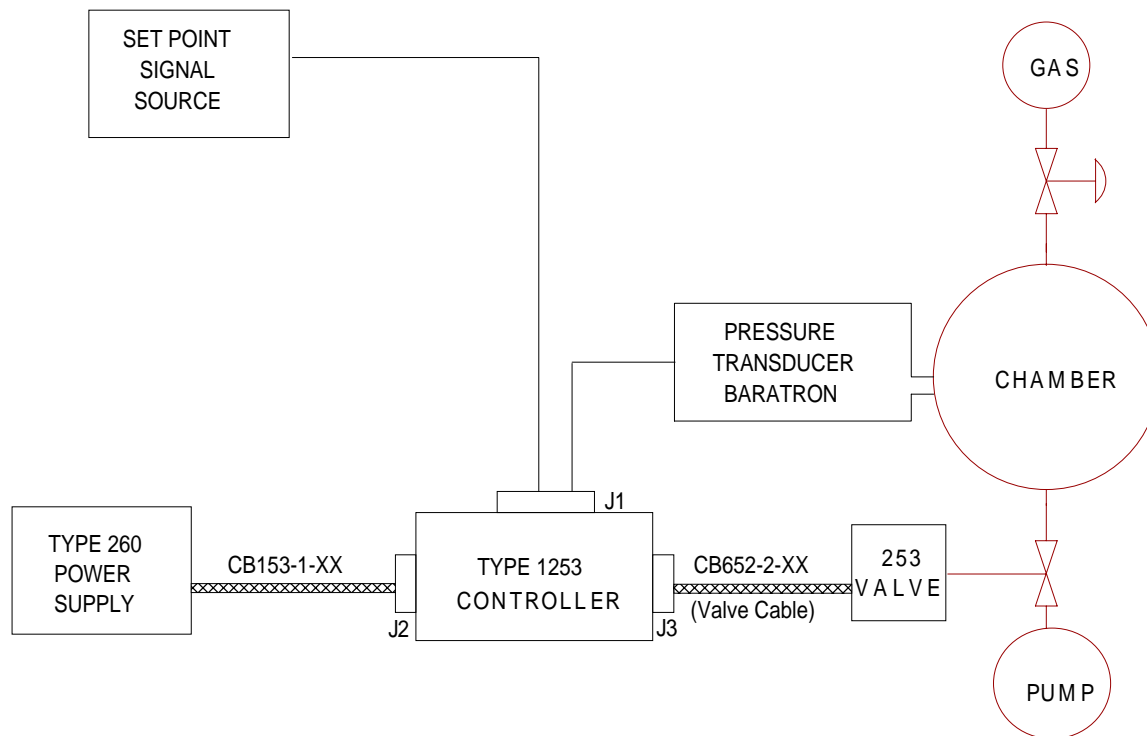

Figure 3: Piping and Cable Interconnections for the Type 1253 Unit

The 1253 controller can receive a set point signal from either an external voltage source or an RS-232 signal. In either case, the INPUT connector (which incorporates the RS-232 communications) acts as the interface. Figure 3 shows an external voltage source connected as the set point signal.

The pressure signal input is also available on the POWER connector (J2). This allows the use of a split power supply cable that can interface the pressure transducer and the 1253 controller through the J2 connector. This leaves J1 empty to interface with the RS-232 port on an external computer.

A CB652-2-xx cable connects the 1253 controller to the valve. Use the minimum length of cable to prevent voltage loss between the 1253 unit and the valve.

The pressure and set point inputs to the Type 1253 controller are both differential inputs that are not internally referenced to ground. Tie the returns to the system ground at a single point. Figure 2, page 23, illustrates this type of grounding.

Generic Shielded Cable Guidelines

Should you choose to manufacture your own cables, follow the guidelines listed below:

1. The cable must have an overall metal *braided* shield, covering all wires. Neither aluminum foil nor spiral shielding will be as effective; using either may nullify regulatory compliance.
2. The connectors must have a metal case which has direct contact to the cable's shield on the whole circumference of the cable. The inductance of a flying lead or wire from the shield to the connector will seriously degrade the shield's effectiveness. The shield should be grounded to the connector before its internal wires exit.
3. With very few exceptions, the connector(s) must make good contact to the device's case (ground). "Good contact" is about 0.01 ohms; and the ground should surround all wires. Contact to ground at just one point may not suffice.
4. For shielded cables with flying leads at one or both ends; it is important at each such end, to ground the shield *before* the wires exit. Make this ground with absolute minimum length. (A ¼ inch piece of #22 wire may be undesirably long since it has approximately 5 nH of inductance, equivalent to 31 ohms at 1000 MHz). After picking up the braid's ground, keep wires and braid flat against the case. With very few exceptions, grounded metal covers are not required over terminal strips. If one is required, it will be stated in the Declaration of Conformity or in the instruction manual.
5. In selecting the appropriate type and wire size for cables, consider:
 - A. The voltage ratings.
 - B. The cumulative I^2R heating of all the conductors (keep them safely cool).
 - C. The IR drop of the conductors, so that adequate power or signal voltage gets to the device.
 - D. The capacitance and inductance of cables which are handling fast signals, (such as data lines or stepper motor drive cables).
 - E. That some cables may need internal shielding from specific wires to others; please see the instruction manual for details regarding this matter.

Product Location and Requirements

153 Unit: Heated Valves

The Type 153 unit is not designed to operate with a heated valve unless certain modifications are made. Some installations require that the exhaust line and throttle valve be heated to prevent exhaust vapors from precipitating out in the exhaust line. For these types of applications, contact MKS Instruments, Inc.

System Considerations

For best pressure control, locate the pressure transducer and the exhaust valve as close as practical to the process chamber. This minimizes the time constants associated with these items. Use tubing that is less than 6 inches long and no less than ¼ inch diameter to connect the transducer and chamber. If the distance must exceed 6 inches, then use a larger diameter tubing to compensate for conductance losses.

Size of the 253 Valve

The 1253 unit controls an external 253 valve (not included). This valve can be sized for a wide variety of applications. The size of the valve is dictated by the size of the vacuum exhaust line and the range of conductance necessary for the pressure and flow rates being used. (Refer to the 253 data sheet for detailed information on the different valves available.)

Setup

Mounting the 153 Unit

The 153 unit can be mounted in a vacuum exhaust line with the proper fittings and connectors. The 153 unit consists of a Type 253 exhaust valve with an electronic housing attached to the motor plate.

Although the 153 unit was designed and tested to operate in the most extreme conditions (with no air circulation and a heated valve at 80° C), it will operate cooler if the air slots in the side of the housing are clear to allow convection air circulation. Typically, electronic components last longer in cooler environments.

Mounting the 1253 Unit

You can mount the 1253 unit in any position. For optimum performance, mount the power supply and 1253 unit near the valve. This reduces the length of cable necessary to connect the valve to the unit and thereby reduces the amount of voltage loss in the valve drive cables. Refer to the 253 valve Instruction Manual for directions on mounting the valve.

Chapter Three: Overview

General Information

MKS products are designed and tested to provide the highest degree of safety attainable. To use your MKS valve safely, you must always conform to the following instructions:

- Refer to the valve instruction manual for directions on installation and operation of the valve.

Warning



The moving parts in the valve create a risk of personal injury until the valve is securely incorporated into a system. To avoid injury keep all objects away from any valve opening.

- Do not insert objects into openings where contact with moving parts is possible.
- Isolate the equipment from any electrical or pneumatic power supply before handling the valve.

Labels

There are two labels on the 153 controller; a pump label and a serial number label. The labels are located on opposite sides of the 153 valve's driver/gear assembly (refer to Figure 5). The 1253 controller only has a serial number label.

Serial Number Label

The serial number label lists the unit's serial number and the product model code, and displays the CE mark, signifying compliance with the European CE regulations.



Figure 4: Serial Number Label

The options for the 153 controller are identified in the model code when you order the unit. Refer to *Appendix B: Model Code Explanation*, page 57, for more information.

Pump Label (153 units only)

The pump label shown in Figure 5 indicates which side of the valve should be oriented towards the high vacuum pump during installation.

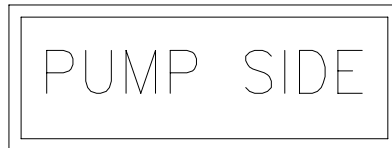

Figure 5: Pump Label

External Connectors and Controls on the 153 Unit

The 153 unit has two external connectors: J1 and J2. Figure 6 shows the location of the two connectors and the top panel of the 153 unit.

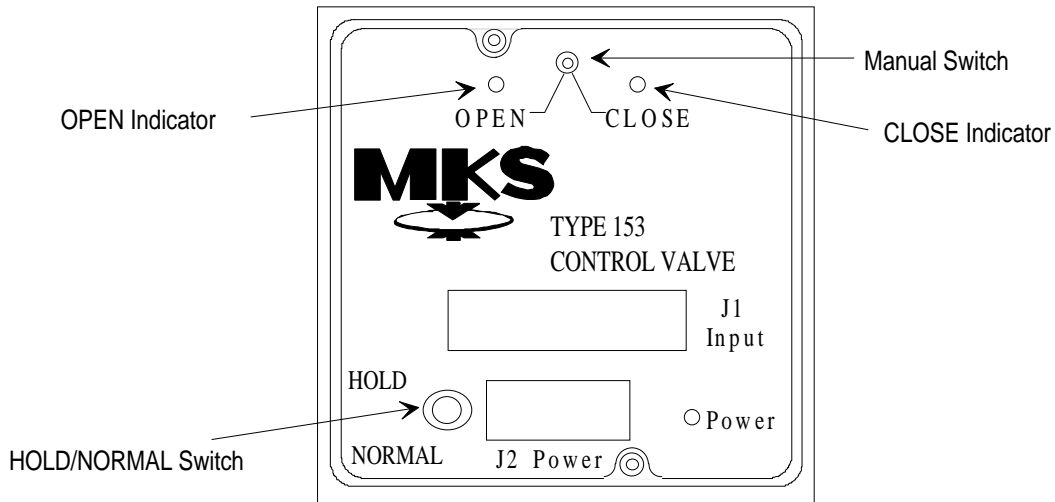

Figure 6: Top Panel of the 153 Unit

J1 - INPUT Connector

J1 is a 25-pin, female Type “D” connector that functions as the INPUT connector. It contains pins for Pressure Input, Set Point Input, RS-232 communications, Power Supply Input, and Limit-Switch Outputs. Table 7, page 30, lists the pinout for the J1 connector.

INPUT Connector (J1) Pinout		
Pin	Description	Also connects to J2 Pin
1	Chassis Ground	9
2	TX (RS-232)	
3	RXD (RS-232)	
4	No Connection	
5	No Connection	
6	No Connection	
7	Digital Common	
8	+5 Volt Output (Powers portable terminal)	
9	Set Point Input (Hi side)	
10	Set Point Return (Lo side)	
11	Power Common (Return for power supply)	2
12	+15/30V Power Supply Input	1
13	Pressure Signal Common (Lo side)	4
14	No Connection	
15	No Connection	
16	No Connection	
17	No Connection	
18	Manual Close Command Line	
19	Manual Open Command Line	
20	Pressure Signal Input (Hi side)	5
21	-15V (External supply to transducer)	3
22	Open Limit-Switch Output	7
23	Close Limit-Switch Output	8
24	Limit-Switch Common	6
25	Chassis Ground	9

Table 7: INPUT Connector (J1) Pinout

J2 - POWER Connector

J2 is a 9-pin male Type “D” connector that serves as the POWER connector. It contains pins for Power Input, Pressure Input, and Limit-Switch Outputs.

POWER Connector (J2) Pinout		
Pin	Description	Also connects to J1 Pin
1	+15 to +30 Volt DC Power Supply Input	12
2	Power Supply Common	11
3	-15V (External supply to transducer)	21
4	Pressure Signal Common (Lo side)	13
5	Pressure Signal Input (Hi side)	20
6	Limit-Switch Common	24
7	Open Limit-Switch Output	22
8	Close Limit-Switch Output	23
9	Chassis Ground	1, 25

Table 8: POWER Connector (J2) Pinout

Manual Switch

The manual switch, located on the top panel of the 153 unit, allows you to manually drive the valve to the open or closed position. Refer to Figure 6, page 29, for the location of the switch. The OPEN indicator light, located to the left of the manual switch, illuminates when the valve is fully open. The CLOSE indicator light is located to the right of the manual switch and illuminates when the valve is in the fully closed position. Use these indicator lights in conjunction with the manual switch when troubleshooting a problem.

HOLD/NORMAL Switch

The HOLD/NORMAL switch, located in the lower left-hand corner of the top panel, allows you to manually hold the valve in a constant position. Refer to Figure 6, page 29, for the location of the switch. The valve operates in the standard way when the switch is in the NORMAL position. The valve is held in a constant position when the switch is placed in the HOLD position. The valve will not move from the Pressure or Set Point signals. To override the HOLD position setting, move the manual switch (change from the OPEN or CLOSE position). The RS-232 commands, Open and Close, will override the HOLD position setting as well.

External Connectors and Controls on the 1253 Unit

The 1253 controller has three external connectors: J1, J2, and J3. Figure 7 shows the front panel of the 1253 unit.

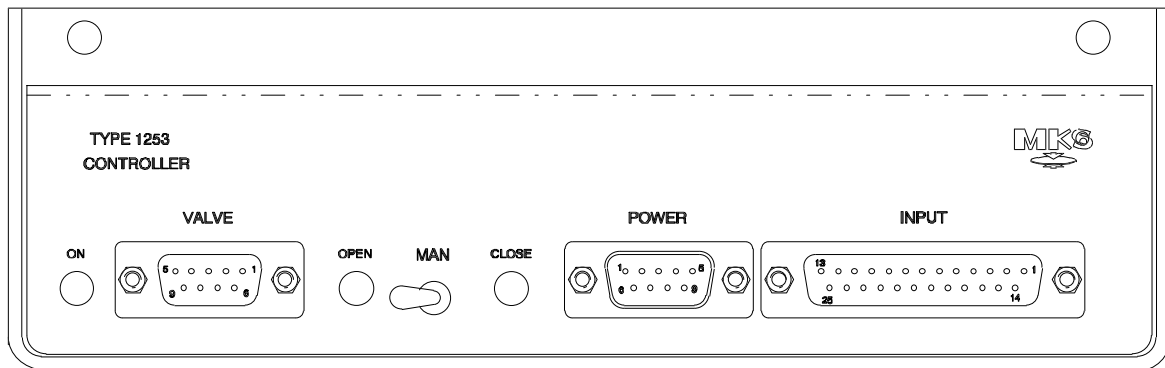

Figure 7: Front Panel of the 1253 Unit

The J1 INPUT connector and the J2 POWER connector function *exactly* the same on the 1253 unit as they do on the 153 unit. Refer to *External Connectors and Controls on the 153 Unit*, page 29, for details on the J1 and J2 connectors.

J3 Connector - VALVE Connector

J3, the VALVE connector, is a 9-pin female Type “D” connector that contains pins to allow the 1253 controller to communicate with the Type 253 valve. The connector includes pins for the valve drive motor and limit switches.

VALVE Connector (J3) Pinout	
Pin	Description
1	Motor upper winding (Lo side)
2	Motor upper winding (Hi side)
3	Digital Ground
4	Open Limit-Switch
5	Close Limit-Switch
6	Motor lower winding (Lo side)
7	Motor lower winding (Hi side)
8	+5 VDC for opto switches
9	Motor return

Table 9: VALVE Connector (J3) Pinout

Manual Switch

The manual switch, (labeled MAN) located to the left of the VALVE connector (J3), allows you to manually drive the valve to the open or closed position. The OPEN indicator light, located to the left of the manual switch, illuminates when the valve is fully open. The CLOSE indicator light is located to the right of the manual switch and illuminates when the valve is in the fully closed position. Use these indicator lights in conjunction with the manual switch when troubleshooting a problem. .

Note



The Type 1253 controller does *not* have the HOLD/NORMAL switch found on the Type 153 unit

Internal Controls on the 153/1253 Controller

The dipswitch bank on the motherboard provides the connections for all the internal controls. Figure 8 shows the location of the dipswitch bank inside the 153/1253 unit.

Dipswitch Bank

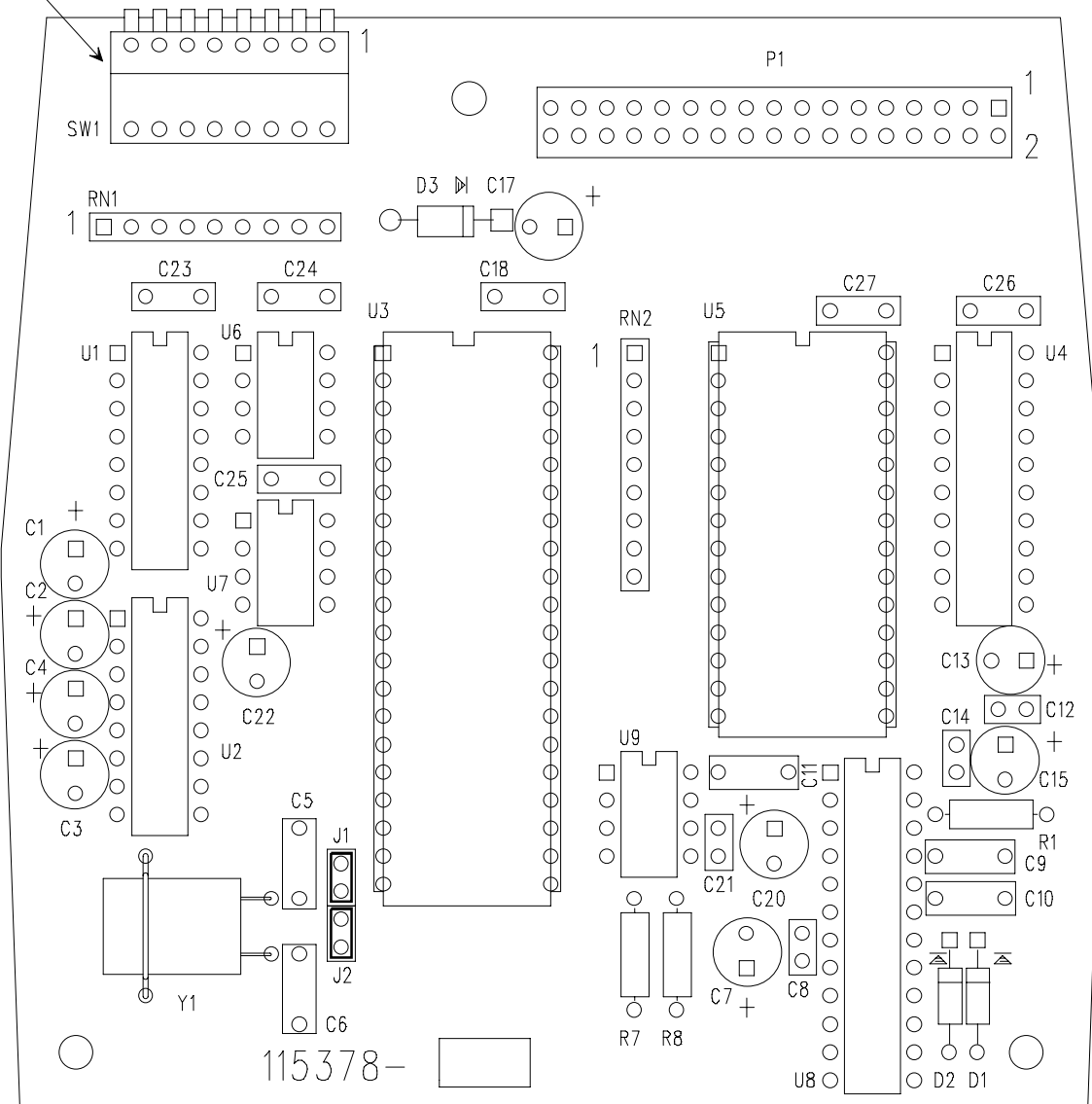

Figure 8: Dipswitch Bank on the Motherboard

The dipswitch bank on the motherboard (CPU board) has 8 dipswitches that allow you to set the 153/1253 unit for a variety of configurations. Table 10, page 35, lists the pin assignments.

Explanation of the Dipswitch Settings		
Dipswitch	OFF (Open)	ON (Closed)
8	Position Controller	Pressure Controller*
7	Digital Set Point	Analog Set Point*
6	Standard RS-232 Protocol	Terminal Protocol*
5	No Parity*	Even Parity
4	1200 Baud	9600 Baud*
3	CR Delimiter*	CR-LF Delimiter
2	Set Point entry (Sxxx.x)	Set Point entry (S1xxx.x)*
1	Reverse Control	Normal Control*
<i>* Indicates default switch settings as shipped from factory</i>		

Table 10: Explanation of the Dipswitch Settings

Switch 8: Selects the method of control. When OFF, the 153/1253 unit acts as a position controller. When the switch is ON the valve acts as a pressure controller.

Switch 7: This switch selects the source of the set point signal. When the switch is OFF, the 153/1253 controller expects to receive the set point signal via the RS-232 interface. When ON, the 153/1253 controller expects the set point signal to be an external analog voltage on the INPUT connector. You can override the analog set point by sending an RS-232 signal to the 153/1253 controller. Use the standard protocol “A” command to revert back to an analog set point.

Switch 6: Establishes the RS-232 protocol. When OFF, the protocol is standard. When ON, the 153/1253 controller uses the portable terminal (PT-1) protocol.

Switch 5: Toggles the parity setting. The OFF setting selects no parity. The ON setting selects even parity.

Switch 4: Sets the baud rate. When OFF, the baud rate is 1200. When ON, the baud rate is 9600.

Switch 3: Selects the end-of-line delimiter. When OFF, the delimiter is a Carriage Return (CR). When ON, the delimiter is a Carriage Return + Line Feed (CRLF).

Switch 2: Controls the RS-232 compatibility for the set point entry. When OFF, the set point entry command is Sxxx.x. When ON, the set point entry is S1xxx.x. The extra 1 makes this entry compatible with other MKS instruments (ex. Types 152, 153A, and 112).

Switch 1: Selects the set point control action. When the switch is OFF, a zero to full scale set point produces an open to close valve action (normal control). When ON, a zero to full scale set point produces a closed to open valve action (reverse control).

Factory Settings

RS-232 Configuration

The 153/1253 unit is shipped with the internal dipswitches set as shown in Table 10, page 35. Refer to Figure 8, page 34, for the location of the dipswitch bank on the motherboard.

Table 11 shows the factory configuration for the RS-232 communications parameters.

Factory Default RS-232 Communication Parameters	
Parameter	Setting
Baud Rate	9600
Parity	NONE
Protocol	TERMINAL (PT-1)
End-of-Line Delimiter	CR

Table 11: Factory Settings for the RS-232 Communication Parameters

Note

The 153/1253 unit is configured for eight data bits and one stop bit. You *cannot* change these settings.

Control Parameters

Table 12 lists the factory default settings for the control parameters.

Factory Default Control Parameter	
Parameter	Setting
Control Type	Pressure
Set Point Type	Analog
Set Point Control	Normal
Pressure Full Scale.	+ 10 Volts
Set Point Full Scale	+ 10 Volts
Gain Setting	10%
Lead Setting	5%

Table 12: Factory Settings for Control Parameters

For information on how to change the control settings, refer to *How To Change the Dipswitch Settings*, page 47.

Power-Down Constants

The 153/1253 unit saves several constants in non-volatile RAM when the power is turned off. When the power is restored, the 153/1253 unit “remembers” these settings. The parameters are listed below:

- Number of valve steps
- Analog set point zero
- Analog pressure zero
- Analog set point full scale
- Analog pressure full scale
- Lead
- Gain
- Present valve position

The following conditions apply at power-up:

- The processor checks the position of all switches on the dipswitch bank
- The operational mode is determined by dipswitches 7 and 8
If dipswitches 7 and 8 are ON, the unit “wakes up” in pressure control mode.
If dipswitches 7 and 8 are OFF, the unit “wakes up” in position control mode.
- The stored constants are recalled and used in all subsequent operations

Valve Slippage Signal

The Type 153/1253 unit has a “Valve Slipped” signal that can be useful when diagnosing exhaust valve or system problems. The Valve Slipped signal is only available through the RS-232 interface.

When the 153/1253 unit contacts either of the limit switches, the internal position signal should equal the appropriate valve position (0 for close, 100% for open). If the position signal is more than 3% different from the appropriate value, the Valve Slipped signal is set to “1” (meaning slipped). When message R8 is sent to the 153/1253 unit, the unit returns either C0 or C1. C0 indicates the valve has not slipped. C1 indicates the valve has slipped *since the last request* (R8). The signal is reset to 0 when it is read by the computer or PT-1.

Valve Slippage

Items that can cause a valve to slip include:

- The flapper was moved while the 153/1253 unit was turned off
- The flapper is rubbing or contacting part of the plumbing
- Particulates are depositing on the wall and slowing the flapper motion

This page intentionally left blank.

Chapter Four: Operation

General Information

The Type 153/1253 controller accepts pressure or position set points from an external computer (via RS-232) or an external analog voltage source, and use an internal digital “PID” algorithm to determine valve position. When the unit is configured for pressure set points, the feedback is an analog pressure signal. This signal is normally 0 to +10 Volts, but the zero and full scale voltages can be adapted to individual applications. (Refer to *Calibration*, page 44, for more information).

The GAIN and LEAD constants used in the control algorithm are set at the factory but you can change these parameters in the field via the RS-232 port, using either a portable terminal or a PC computer.

When the set point is a position control command (Refer to *Internal Controls on the 153/1253 Controller*, page 34, for details on how to set this command), the valve is moved as a result of the position control command, and no feedback signal is generated.

How To Learn the Valve with the 1253 Controller

Unlike the 153 unit that contains both the valve and the controller inside its housing, the valve is external to the 1253 controller. It is not always possible to match the controller to the valve at the factory. Therefore, to ensure proper control you must instruct the 1253 controller to learn the valve it is controlling.

You must initiate the learn process via RS-232 communications, on either a PC or a MKS PT-1 portable terminal. Refer to *RS-232 Communications*, page 46, for more information.

Note

Regardless of the communication device used, the control characters used are identical.

1. Configure your system to withstand the change in valve position from the fully open to fully closed position.

Otherwise your system may be damaged during this procedure.

2. Verify that the 1253 unit is powered on and connected to the valve via the 652-2-xx cable.

During the learning mode, the 1253 unit will drive the valve from the fully closed to fully open.

3. Enter:

V ↵

The 1253 unit responds by initiating the learn process.

4. Enter:

C ↵

The 1253 unit responds by driving the valve to the fully closed position.

Refer to *Calibration*, page 44, for more information on the commands.

How To Tune the 153/1253 Controller

1. Apply power to the 153/1253 unit and turn on the upstream gas source(s).
2. Apply the desired analog set point signal or an RS-232 message.

The 153/1253 unit responds by changing the pressure smoothly to the desired value. If the pressure is slow changing to the desired value (over 30 seconds), or oscillates, then adjust the LEAD and/or GAIN. Use the RS-232 communication link to change the LEAD and GAIN values. Refer to *RS-232 Communications*, page 46, for a description of the control characters to use.

3. Increase the LEAD setting if the pressure overshoots the selected value.

If there is no overshoot, and particularly if the pressure is slow approaching the set point value, then reduce the LEAD setting. Repeat this test to confirm that the LEAD setting is appropriate. Note that the correct LEAD setting for a rise in pressure is normally *not* the same LEAD setting for a drop in pressure. Therefore, duplicate the test for the LEAD parameter with the same set point and direction as required in the process.

4. Reduce the GAIN setting if the pressure oscillates about the correct value.

The highest possible GAIN setting produces the best pressure control, therefore, reduce the GAIN setting in very small increments.

Note



The speed of pressure response is relative and depends on chamber size and absolute pressure. Lower pressures (less than 10 microns) are usually slower because of the slower molecular flow and reduced pumping speed.

The maximum rate of rise of pressure is determined by the following formula (with the exhaust valve fully closed).

$$Pr = F/V$$

Where:

Pr	=	pressure rate of rise in Torr/sec.
F	=	flow in Torr-liters/sec.
V	=	volume in liters.

Consequently, in systems with small input flows and relatively large volumes, the pressure will rise slowly even when the control valve is fully closed.

If the controller cannot achieve good control, the problem may be caused by improper pneumatic connections. Refer to *System Considerations*, page 26, to read about factors which effect pressure control.

How To Calibrate the 153/1253 Controller

The 153/1253 unit can perform five calibrations. They are:

- Learn analog set point zero
- Learn analog pressure zero
- Learn analog set point full scale
- Learn analog pressure full scale
- Learn number of valve steps

You must issue these commands via RS-232 communication. To do this, connect a computer or an MKS PT-1 to the 153/1253 controller.

Learn the Analog Set Point Zero

1. Supply zero input voltage on INPUT connector, J1, pin 9.
2. Send the Learn Analog Set Point Zero command:

Type **Z1**, and press ENTER

The 153/1253 controller learns the input voltage that corresponds to an analog set point zero value. The analog set point zero value is set to 0.0 Volts at the factory.

Learn the Analog Set Point Full Scale

1. Supply full scale input voltage on INPUT connector, J1, pin 9.

Before you issue this command, be sure that the input voltage is at least 9% of the 10 V full scale voltage. If the voltage is less than 9% of the typical full scale voltage, the 153/1253 controller ignores the learn command and retains the previous value. This eliminates the possibility of learning an erroneous voltage value.

2. Send the Learn Analog Set Point Full Scale command:

Type **F1**, and press ENTER

The 153/1253 controller learns the input voltage that corresponds to the analog set point full scale value. The analog set point full scale value must be between +1 and +10 Volts. It is set to +10.0 Volts at the factory.

Learn the Analog Pressure Zero

1. Warm-up the transducer and pump it below its resolution.
2. Send the Learn Analog Pressure Zero command:

Type **Z2**, and press ENTER

The 153/1253 controller verifies that the pressure transducer is properly warmed-up and pumped below its resolution. The 153/1253 learns the pressure input that corresponds to the analog pressure zero value. The analog pressure zero value is factory set to 0.0 Volts.

Learn the Analog Pressure Full Scale

1. Warm-up the transducer and set up the pressure system for full scale pressure.

Before you issue this command, be sure that the input voltage is at least 9% of the 10 V full scale voltage. If the voltage is less than 9% of the typical full scale voltage, the 153/1253 controller ignores the learn command and retains the previous value. This eliminates the possibility of learning an erroneous voltage value.

2. Send the Learn Analog Pressure Full Scale command:

Type **F2**, and press ENTER

The 153/1253 controller raises the pressure to the full scale value of the transducer. The 153/1253 learns the pressure input that corresponds to the analog pressure full scale value. The analog pressure full scale value is factory set to +10.0 Volts.

Learn the Number of Valve Steps

- Send the Learn Number of Valve Steps command:

Type **V** and press ENTER

The 153/1253 controller opens and closes the valve, so be sure that it will not affect your system. Factory set for the attached valve.

How the 153/1253 Controller Handles the Calibration Voltages

When a voltage enters the 153/1253 controller as a calibration signal, for a pressure full scale or pressure zero reading, the controller scales the signal to allow for a slightly overrange or underrange signal. The controller does not convert the signal back to a full 0 to 10 V range. Therefore, when you query the controller for a pressure zero or pressure full scale reading, it will return the offset value, rather than the true zero or full scale voltage reading.

How To Switch Between Normal and Reverse Modes

The Normal/Reverse Switch (switch 1 on the Dipswitch bank) switches the Type 153/1253 controller from a “normal” mode of operation, to “reverse” mode of operation. The modes are:

Normal - Pressure above the set point causes the valve to move toward *open* position.

Reverse - Pressure above the set point causes the valve to move toward *close* position.

How To Communicate via RS-232

The 153/1253 controller can communicate with an external computer or a portable terminal (PT-1) via the RS-232 interface. The computer can read pressure, valve position, and tuning parameters. It can also change the set point, open and close the valve, and change the tuning parameters.

How To Connect to a PC

The cable that connects the 153/1253 unit to the PC must be a “NULL MODEM” cable. A null modem cable has pins 2 & 3 reversed from one end of the cable to the other. Any commercial RS-232 cable may be used as long as the above pin reversal is made. Figure 9 shows the pin assignments on a null modem cable.

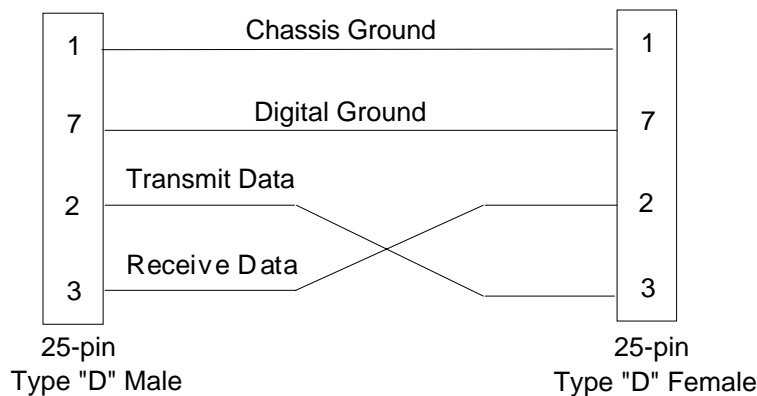

Figure 9: RS-232 Communication Cable (Null Modem)

1. Connect the computer to connector J1 on the 153/1253 unit with a null modem cable.

- Configure identical communication parameters on the 153/1253 unit and the PC. Table 13 lists the communication parameters and the 153/1253 unit default settings.

RS-232 Communications Settings	
Parameter	Settings
Baud Rate	9600
Parity	NONE
Stop Bits	ONE*
Data Bits	EIGHT*
End-of-Line Delimiter	CR
Handshaking	OFF*
* <i>Setting cannot be changed</i>	

Table 13: RS-232 Communications Settings

To change the baud rate, parity, or end-of-line delimiter on the 153/1253 unit, you must change dipswitch settings.

Note

The 153/1253 unit is configured for eight data bits, one stop bit and no handshaking. You *cannot* change these settings.

How To Change the Dipswitch Settings

In order to change the communication parameters on the 153/1253 unit, you must change the dipswitch settings on the motherboard. Table 10, page 35, lists the dipswitch assignments.

- Unplug the power cord.

Warning

To avoid an electrical shock, disconnect the power cord *before* opening the unit.

- Open the 153/1253 unit to expose the motherboard.
 - 153 Unit:** Unscrew the two screws on the top of the unit and lift off the cover.
 - 1253 Unit:** Unscrew the four screws on the top of the unit and lift off the cover.
- Flip switch 5 to the ON position.
This configures the 153/1253 unit for even parity.

4. Flip switch 3 to the ON position.

This configures the 153/1253 unit to use a carriage return-line feed (CRLF) as the end-of-line delimiter. When switch 3 is in the OFF position, the end-of-line delimiter is a carriage return (CR).

Note

You must reboot the system before any changes to the dipswitch setting are recognized by the 153/1253 unit.

5. Replace the cover of the unit.

How To Connect to the MKS PT-1

The PT-1 comes with its RS-232 communication cable attached.

- Plug the Type “D” connector into J1.

The default communication parameters for the 153/1253 unit configure it to communicate with the PT-1. The default settings are listed in Table 11, page 36.

Standard Protocol

Table 14 lists the standard protocol commands that enable you to operate the 153/1253 controller remotely.

Note



Commands must be followed by ENTER, < ↵ >, and dipswitch 6 must be set to OFF.

Table 9 lists the standard protocol commands:

Standard Protocol Commands	
Command	Action
A*	Go to analog set point level and control*
B	Resets the controller, relearns the valve, and uses the operating parameters listed in Table 16, page 50.
C	Close the valve
D	Same as A
F1	Learn analog set point full scale
F2	Learn analog pressure full scale
G xxx.x	Set controller gain (in percent)
H	Hold valve position
L xxx.x	Set controller lead (in percent)
O	Open the valve
P xx.x	Set valve position (in degrees)
Ry**	Report following data**
S xxx.x	Set pressure set point (in percent)
V	Learn valve steps
X	Reports valve position continuously (for PT-1 only)
Z1	Learn analog set point zero
Z2	Learn analog pressure zero
<i>*Dipswitch 7 must be in the default ON(Closed) position</i>	
<i>**Report responses are listed in Table 15, page 50</i>	

Table 14: Standard Protocol Commands

Report Command Responses			
R_y	Parameter	Responses	Units
R ₁	Digital Pressure Set Point	S xxx.x	Percent
R ₂	Gain	G xxx.x	Percent
R ₃	Lead	L xxx.x	Percent
R ₄	Analog Set Point	A xxx.x	Percent
R ₅	Pressure	P xxx.x	Percent
R ₆	Position	V xxx.x	Degrees
R ₈	Slipped ?	C x	0 = OK 1 = Slipped
R ₁₀	Set Point Zero	ZA xxx.x	Percent
R ₁₁	Pressure Zero	ZB xxx.x	Percent
R ₁₂	Set Point F.S.	FA xxx.x	Percent
R _{y13}	Pressure F.S.	FB xxx.x	Percent

Table 15: Report Command Responses

Operating Values Established By the “B” Command	
Parameter	Value
Lead	4.0%
Gain	90.0%
Set Point	0.0%
Pressure Zero	0.0 Volts
Set Point Zero	0.0 Volts
Pressure Full Scale	10.0 Volts
Set Point Full Scale	10.0 Volts

Table 16: Operating Values Established By The “B” Command

How To Reset the 153/1253 Controller

The “B” command resets the controller, relearns the valve, and establishes settings for the lead, gain, set point, and the full scale and zero voltage levels for both the pressure input and set point input.

Note



The learn procedure causes the valve to move to the full open and full close positions. Be sure that your system can withstand these valve positions *before* issuing the “B” command.

Table 16, page 50, lists the operating values used by the “B” command. You may need to reset the lead, gain, and set point values to the values used prior to resetting the controller. To reset the zero and full scale settings, refer to *How To Calibrate the 153/1253*, page 44, of your Instruction Manual.

Portable Terminal (PT-1) Protocol

When using the portable terminal (PT-1), leave the 153/1253 unit configured with the default settings. Table 17 lists the default settings of the dipswitch bank.

Dipswitch Settings for Portable Terminal Protocol	
Dipswitch	Position
8	ON (Closed)
7	ON (Closed)
6	ON (Closed)
5	OFF (Open)
4	ON (Closed)
3	OFF (Open)
2	ON (Closed)
1	ON (Closed)
<i>The settings correspond to the default settings</i>	

Table 17: Dipswitch Settings for Portable Terminal Protocol

When configured this way, the 153 unit accepts RS-232 characters from the PT-1 *without needing the shift key* on the portable terminal. Each instruction should be followed by < ↵ >. Commands are identical to the Standard Protocols listed in Table 14, page 49.

New Set Point Syntax

When dipswitch 2 is ON, (the default setting) the set point entry is downwardly compatible with other instruments such as MKS models 152, 153A, and 112.

When dipswitch 2 is OFF, the “1” is dropped from the command string and the syntax becomes: Sxxx.x.

In some cases, particularly when using a portable terminal, typing the additional “1” is inconvenient. For example, you would need to type “S15” to enter a set point of 5%. With dipswitch 2 OFF, you only need to type “S5” to enter the same set point.

How To Connect the 153/1253 to the Type 146 Cluster Gauge™

The Type 146 Cluster Gauge can control the 153/1253 unit. To configure the 153/1253 unit to communicate with the 146 instrument, leave the dipswitches at the default settings (refer to Table 10, page 35, for a list of the default settings) *except* for switch 8. Set switch 8 to the OFF(Closed) position, so the 153/1253 unit will act as a position controller. The system will then use the PID control on the 146 instrument to control the valve. Refer to *How To Change the Dipswitch Settings*, page 47, for instructions on how to change switch 8.

Note



The 146 instrument must contain the optional “M” board (Control Board) to control the 153/1253 unit.

1. Use a CB-153-13-10 cable to connect the 153/1253 unit to the “M” board (Control Board) in the 146 instrument.

This cable uses the 146 instrument to power the 153/1253 unit and provides the analog voltage to position the valve to control pressure.
2. On the 146 instrument, use the Setup Mode Code 14x to select the control action (direct for downstream control) and the pressure reference channel.
3. Use the Open and Close commands on the 146 instrument to move the valve from fully open to fully closed.

Watch the Open and Close LED lights on the 153/1253 unit. If the appropriate light is illuminated when the valve is in position, the zero and full scale settings are correct. If the appropriate light is not illuminated correctly, proceed to step 4.
4. Use either a PT-1 portable terminal or a PC to calibrate the 153/1253 unit.

The 153/1253 unit will learn the new values for zero and full scale. Refer to *How To Calibrate the 153/1253*, page 44, for details.

Chapter Five: Maintenance

General Information

Periodically check for wear on the cables and inspect the enclosure for visible signs of damage.

How To Clean the Unit

Periodically wipe down the unit with a clean, damp cloth.

This page intentionally left blank.

Appendix A: Product Specifications

Electrical Specifications

CE Compliance	
Electromagnetic Compatibility ¹	EMC Directive 89/336/EEC
Machinery Directive	Directive 89/392/EEC
Control Lines	OPEN and CLOSE Valve control lines (Activated by an active low TTL) Hi input maximum voltage is 30 Volts and drawing less than 200 μ A of leakage current
Input Power	Minimum =+14 VDC to maximum +30 VDC @ less than 5 Watts If a transducer is connected to the 153/1253, its power can be supplied by the same external supply used by the 153/1253, or by a separate external supply.
Outputs	Opto-coupled Limit Switch (L.S.) One for Open, one for Close. 30 V maximum, 10 mA maximum
Power Loss	Unit saves calibration constants and valve position
Pressure Input Signal	0 to +10 Volts DC (normally) Can be calibrated to any full scale voltage from 1 to 10 Volts
RS-232	Bi-directional communication Input - set point and learn commands (in 0.1% increments) Output - (on request) actual position, pressure (in 0.1% increments) “Out of Sync” - Valve Slipped
Set Point Input Signal	0 to +10 Volts DC (normally) Can be calibrated to any full scale voltage from 1 to 10 Volts

¹An overall metal braided shielded cable, properly grounded at both ends, is required during use.

Performance Specifications

Display	One Red LED for OPEN Limit Switch One Red LED for CLOSE Limit Switch One Green LED for Power
Manual Switch	Toggle switch directs valve to OPEN or CLOSE position 153 only - Normal/Hold Switch toggles valve between normal operation and hold operation which holds the valve in position
Valve Speed - OPEN to CLOSE	Normal - 7.5 seconds Fast - 1.8 seconds (Ref SP021-84)

Physical Specifications

Connectors	One 25-pin “D” female for input signals and power input One 9-pin “D” male for power input or output, and signal inputs
------------	--

Environmental Specifications

Ambient Operating Temperature Range	
1253 and 153 electronics module	15° to 40° C (59° to 104° F)
253 valve component of the 153 unit	0° to 90° C (32° to 194° F)

Due to continuing research and development activities, these product specifications are subject to change without notice.

Appendix B: Model Code Explanation

Model Code for the Type 153 Unit

The options for your valve are identified in the model code when you order the unit.

Type Number

The type number designates the model number of the valve.

Type 153 with ASA Flanges

Type Number	Nominal Inside Diameter inches (mm)	ASA Flange Size	Flapper O-Ring
153D-2-2-1	1.888 (48)	2"	Yes
153D-2-2-2	1.950 (50)	2"	No
153D-60-2-1	2.362 (60)	2"	Yes
153D-60-2-2	2.362 (60)	2"	No
153D-3-2-2	3.025 (77)	2"	No
153D-3-3-2	3.025 (77)	3"	No
153D-4-3-2	3.965 (101)	3"	No
153D-4-4-2	3.965 (101)	4"	No
153D-6-4-2	5.781 (147)	4"	No
153D-6-6-2	5.781 (147)	6"	No
153D-8-6-2	7.501 (191)	6"	No
153D-8-8-2	7.501 (191)	8"	No
153D-10-10-2	10.000 (254)	10"	No

Type 153 with KF or NW ISO Flanges

Type Number	Nominal Inside Diameter inches (mm)	ISO Flange Size	Flapper O-Ring
153D-20-40-1*	0.779 (20)	KF-40	Yes
153D-20-40-2*	0.779 (20)	KF-40	No
153D-1-40-1*	1.270 (32)	KF-40	Yes
153D-1-40-2*	1.270 (32)	KF-40	No
153D-2-50-1*	1.888 (48)	KF-50	Yes
153D-2-50-2*	2.000 (51)	KF-50	No
153D-60-63-1	2.362 (60)	NW-63	Yes
153D-60-63-2	2.362 (60)	NW-63	No
153D-3-80-2	3.000 (76)	NW-80	No
153D-4-100-2	3.875 (98)	NW-100	No
153D-6-160-2	5.750 (146)	NW-160	No
153D-8-200-2	7.650 (194)	NW-200	No
153D-10-250-2	9.700 (246)	NW-250	No
<i>* Available with optional heater; consult factory for more information.</i>			

Type 253 with CF Flanges

Type Number	Nominal Inside Diameter inches (mm)	CF Flange Size	Flapper O-Ring
153D-20-2CF-1	0.779 (20)	2¾"	Yes
153D-20-2CF-2	0.779 (20)	2¾"	No
153D-1-2CF-1	1.270 (32)	2¾"	Yes
153D-1-2CF-2	1.270 (32)	2¾"	No
153D-2-3CF-1	1.888 (48)	3⅜"	Yes
153D-2-3CF-2	2.000 (51)	3⅜"	No
153D-2-4CF-1	2.000 (51)	4½"	Yes
153D-2-4CF-2	2.000 (51)	4½"	No
153D-3-6CF-2	3.000 (76)	6"	No
153D-4-6CF-2	3.875 (98)	6"	No

Type 153 with JIS Flanges

Type Number	Nominal Inside Diameter inches (mm)	JIS Flange Size	Flapper O-Ring
153D-2-50J-1	1.888 (48)	JIS-50	Yes
153D-2-50J-2	2.000 (51)	JIS-50	No
153D-4-100J-2	3.875 (98)	JIS-100	No

Model Code for the Type 1253 Unit

The model code for this stand-alone electronics module is:

1253D

There are no options to specify through the model code.

1

1253 controller

external controls, 32–33

front panel, 32

internal controls, 34–35

MAN switch, 33

mounting, 26

VALVE connector, 32

153 and 1253, descriptions of, 17

153 controller

external controls, 29–31

INPUT connector, 29

interconnections, 21–23

internal controls, 34–35

manual switch, 31

mounting, 26

top panel, 29

A

Analog set point, 17, 24

ASA flanges

model codes, 57

B

Baud rate, 35, 36

C

Cabling, 20

Calibration, 44

Calibration voltages, 45

CE Mark, 28

Index

CF flanges

model codes, 59

Connectors

1253 unit, 32–33

153 unit, 29–31

Control method selection, 35

Control parameters, 41

Control parameters, factory defaults, 37

Control parameters, setting, 43

Customer support, 18

D

Dipswitch bank, 34–35, 51

Dipswitch settings, changing, 47

E

External controls

1253 controller, 32–33

153 controller, 29–31

F

Factory defaults

control parameters, 37

RS-232 parameters, 36

Flanges, 57–60

H

Heated valve instructions, 26

HOLD/NORMAL switch, 31

I

Informations relatives à la sécurité pour la valve, 5

Interconnections

153 controller, 21–23

Interface cables, 20

Internal controls, 34–35

Introduction, 17

J

JIS flanges

model codes, 59

K

KF ISO flanges

model codes, 58

L

Labels, 28

Learn commands, 44, 49

Learning the valve, 42

M

Manual organization, 18

Medidas de seguridad de la válvula, 13

Model codes, 57–60

Motherboard, 34

Mounting

1253 controller, 26

153 controller, 26

N

Normal mode, 35

Normal/Reverse switch, 46

NULL MODEM cable, 46

NW ISO flanges

model codes, 58

P

Portable terminal protocol, 51

Position control, 17

POWER connector, 31

Power down constants, 38

Power requirements, 17

Pressure control, 17

Product specifications, 55

Protocol, 35

Pump label, 28

R

Reset command, 51

Returning the product, 18, 19

Reverse mode, 35

RS-232 communication, 46–51

baud rate, 35

communication parameters, 47

connections, 46

data bits, 36, 47

end-of-line delimiter, 35

factory configuration, 36

MKS PT-1, 48

NULL MODEM cable, 46

parity, setting, 35

portable terminal protocol, 51

protocol, selecting, 35

stop bit, 36, 47

S

Serial number label, 28

Set point, 41

 control action, 35

 format, 35

 signal, 49

 signal source, 35

 syntax, 52

Sicherheitshinweise für das Ventil, 9

Standard protocol, 49–51

System considerations, 26

T

Tuning, 43

U

Unpacking instructions, 19

V

VALVE connector, 32

Valve Safety Information, 1

Valve slippage signal, 39