



**974B QuadMag™
Vacuum pressure transducer
RS232 / RS485**

Operation and Installation Manual

P/N: 100017137
974B QuadMag™ Transducer
Operation and Installation Manual
Revision: G, September 2014

Extent of the Warranty

MKS Instruments, Inc., HPS™ Products Inc. and MKS Denmark ApS. warrants the 974B QuadMag Vacuum Transducer and its accessories to be free from defects in materials and workmanship for one (1) year from the date of shipment by HPS™ or authorized representative to the original purchaser (PURCHASER). Any product or parts of the product repaired or replaced by HPS™ under this warranty are warranted only for the remaining unexpired part of its one (1) year original warranty period. After expiration of the applicable warranty period, the PURCHASER shall be charged HPS™' current prices for parts and labour, plus any transportation for any repairs or replacement.

ALL EXPRESS AND IMPLIED WARRANTIES, INCLUDING THE IMPLIED WARRANTIES OF MERCHANTABILITY AND FITNESS FOR A PARTICULAR PURPOSE, ARE LIMITED TO THE WARRANTY PERIOD. NO WARRANTIES, EXPRESS OR IMPLIED, WILL APPLY AFTER THIS PERIOD.

Warranty Service

The obligations of HPS™ under this warranty shall be at its option: (1) to repair, replace, or adjust the product so that it meets applicable product specifications published by HPS™ or (2) to refund the purchase price.

What Is Not Covered

The product is subject to above terms only if located in the country of the seller from whom the product was purchased. The above warranties do not apply to:

- I. Damages or malfunctions due to failure to provide reasonable and necessary maintenance in accordance with HPS™ operating instructions.
- II. Damages or malfunctions due to chemical or electrolytic influences or use of the product in working environments outside the specification.
- III. Fuses and all expendable items which by their nature or limited lifetime may not function for a year. If such items fail to give reasonable service for a reasonable period of time within the warranty period of the product; they will, at the option of HPS™, be repaired or replaced.
- IV. Defects or damages caused by modifications and repairs effected by the original PURCHASER or third parties not authorized in the manual.

Condition of Returned Products

HPS™ will not accept for repair, replacement, or credit any product which is asserted to be defective by the PURCHASER, or any product for which paid or unpaid service is desired, if the product is contaminated with potentially corrosive, reactive, harmful, or radioactive materials, gases, or chemicals. When products are used with toxic chemicals, or in an atmosphere that is dangerous to the health of humans, or is environmentally unsafe, it is the responsibility of the PURCHASER to have the product cleaned by an independent agency skilled and approved in the handling and cleaning of contaminated materials before the product will be accepted by HPS™ for repair and/or replacement.

In the course of implementing this policy, HPS™ Customer Service Personnel may inquire of the PURCHASER whether the product has been contaminated with or exposed to potentially corrosive, reactive, harmful, or radioactive materials, gases, or chemicals when the PURCHASER requests a return authorization. Notwithstanding such inquiries, it is the responsibility of the PURCHASER to ensure that no products are returned to HPS™ which have been contaminated in the aforementioned manner.

Other Rights and Remedies

I. These remedies are exclusive. HPS™ SHALL NOT BE LIABLE FOR CONSEQUENTIAL DAMAGES, FOR ANTICIPATED OR LOST PROFITS, INCIDENTAL DAMAGES OR LOSS OF TIME, OR OTHER LOSSES INCURRED BY THE PURCHASER OR BY ANY THIRD PARTY IN CONNECTION WITH

THE PRODUCT COVERED BY THIS WARRANTY, OR OTHERWISE. Some states do not allow exclusion or limitation of incidental or consequential damage or do not allow the limitation on how long an implied warranty lasts. If such laws apply, the limitations or exclusions expressed herein may not apply to PURCHASER.

II. Unless otherwise explicitly agreed in writing, it is understood that these are the only written warranties given by HPS™. Any statements made by any persons, including representatives of HPS™, which are inconsistent or in conflict with the terms of the warranty shall not be binding on HPS™ unless reduced to writing and approved by an authorized officer of HPS™.

III. This warranty gives PURCHASER specific legal rights, and PURCHASER may also have other rights which vary from state to state.

IV. For HPS™ products sold outside of the U.S., contact your MKS representative for warranty information and service.

Warranty Performance

To obtain warranty satisfaction, contact the following:

US & ASIA:

MKS Instruments, Inc., HPS™ Products, Inc., 5330 Sterling Drive, Boulder, CO 80301, USA, Phone: (303) 449-9861.

EUROPE:

MKS Denmark ApS, Ndr. Strandvej 119G, DK3150 Hellebaek, Denmark, Phone: +45 44 92 92 99, E-mail: mksdenmark@mksinst.com

Statement of Export Control

These commodities, technology or software were provided in accordance with the US Export Administration Regulations and Export regulations of the European Union. Diversion or transfer contrary to U.S. or European Union law is prohibited.

Part number: 974B- _____
Serial number: _____
Please fill in these numbers and have them readily available when calling for service or additional information. The part number can be found on your packing slip, and both the part number and serial number are located on the side of the housing.



This manual is valid for 974B transducers with serial number 1022432056 and higher.

© 2009 MKS Instruments. All rights reserved.

Trademarks used in this manual: HPS™, Baratron®, QuadMag™, DualTrans™, MicroPirani™ and Quattro™ are trademarks of MKS Instruments Inc. Windows® is a trademark of Microsoft Corporation. Viton® is a trademark of DuPont Performance Elastomers L.L.C.

Table of Contents

Safety information	2
Symbols used:	2
Unpacking	3
Description	4
974B Functions	5
User Switch	5
LED Status Indicator	5
Transducer installation (mechanical)	6
Transducer installation (electrical)	7
Serial user interface	9
Communication Protocol	10
Setpoint relays	12
Display	14
Cold Cathode setup	18
Calibration and adjustment	20
Factory default	24
Transducer lock function	25
User Switch Command	25
Transducer test	25
Status Query Commands	26
Analog output	27
MicroPirani gas dependence	48
Query Command list	50
Setup and configuration command list	51
Firmware upgrades (RS232 only)	52
FAQ (Frequently Asked Questions)	53
Trouble shooting	55
Service and Repair	56
Specifications	57
Accessories and replacement part numbers	61
CE Declaration of Conformity	62
Index	64

For more information contact:

MKS Denmark ApS.
Ndr. Strandvej 119G
DK-3150 Hellebaek
Denmark

Tel: +45 44 92 92 99 – Fax: +45 44 92 94 99
E-mail: mksdenmark@mksinst.com



MKS Instruments, HPS Products
5330 Sterling Dr.
Boulder, CO 80301
USA

Tel: 303 449 9861 Fax: 303 449 2003

Safety information:

Symbols used:







The first symbol below is used throughout this manual to further define the safety concerns associated with the product. The last two symbols identify other information in this manual that is essential or useful in achieving optimal performance from the 974B QuadMag transducer.

Caution:		Refer to manual. Failure to read message could result in personal injury or serious damage to the equipment or both.
Critical:		Failure to read message could result in damage to the equipment.
Attention:		Calls attention to important procedures, practices or conditions.

General safety information

The safety instructions should always be followed during installation and operation of the 974B QuadMag transducer. Pass safety information to all users.

Safety Precautions:

	Electrical connections. The 974B must be properly electrically connected in order to perform according to the specifications. Output pins are not protected against wrong electrical connections. Wrong electrical connections can cause permanent damage to the transducer or interference to measuring performance. Refer to Electrical connections description page 7.
	Fuse. The 974B power supply input has an internal thermal fuse. The fuse is self recoverable and should not be changed.
	Explosive Environments. Do not use the 974B in presence of flammable gases or other explosive environments. Corrosive Environments. The 974B is not intended for use in corrosive environments. Refer to Transducer installation page 6.
	Service and Repair. Do not substitute parts or modify the 974B transducer other than described in Service and Repair page 56. Do not install substituted parts or perform any unauthorized modification to the transducer. Return the transducer to a MKS Calibration and Service Center for service and repair to ensure all of the safety features are maintained.
	Magnetic interference. The 974B contains a strong permanent magnet that can interfere with performance and operation of other electronics equipment and life support devices like pacemakers. Only install the 974B where it cannot interfere with other electronics.
	CE marking The 974B transducer complies with European standards for CE marking. Refer to Declaration of Conformity page 62. 

Unpacking

Before unpacking your 974B QuadMag transducer, check all surfaces of the packing material for shipping damage. Inspect for visible damage. If found, notify the carrier immediately. Please be sure that your 974B package contains these items:

Part number	Description
974B-xxxxx	974B Transducer
100017136	Short form manual
100017096	Documentation & Software CD

If any items are missing, please call MKS Customer Service at (800)345-1967 or (303)449-9861 or your local MKS sales office or distributor.

Part number

The 974B QuadMag part number system has 5 digits that identify flange, communication interface, analog output type, I/O connector and sensor sealing type. Transducers can be delivered with customer configuration of various parameters like setpoint settings and these specials have additional 4 digits after the regular part number.

	Flange	Interface	Analog out	Connector Relays	Enclosure sealing
974B-	1	1	0	2	0
					0 Standard / Viton sealing 4 Display / Viton sealing
					2 SUBD 15pinHD male / no relay 3 SUBD 15pinHD male / 3 relays 4 SUBD 15pinHD male / 3 relays / Piezo Aout 5 SUBD 15pinHD male / 3 relays / Dual Aout 8 RJ45/FCC68 8 pin (Edwards/Oerlikon type) 9 Hirschmann 6 pin (Pfeiffer / Inficon type)
					0 Standard mks 1 Edwards APG-L 3 Edwards WRG 5 Inficon MPG400 / Pfeiffer PKR251 6 Inficon BPG400 (999 DAC2)
					1 RS232 / Analog 2 RS485 / Analog
					0 Custom 2 KF25 7 CF2.75 9 KF40

Special versions

Part number

- 974B-x1380 Edwards WRG pin and output compatible
- 974B-x1580 Oerlikon PTR90, Inficon MPG400 pin and output compatible
- 974B-x1590 Pfeiffer, Inficon PKR251 pin and output compatible

Description

The 974B QuadMag™ vacuum transducer offers a wide measuring range from 1×10^{-8} to 1000 Torr and is based on measurement of thermal conductivity, mechanical deflection of a silicon membrane and cold cathode ionization current.



The 974B is designed for semiconductor loadlock pressure controlling, general purpose pressure measurement and control as a standalone unit or with the PDR900 display and controller unit. The transducer uses RS232 or RS485 digital communication interface for setup of transducer parameters and to provide real time pressure measurement.



The 974B has up to three mechanical relays which can be used for process control, for example interlocking valves or pumps. The analog voltage output can be interfaced to external analog equipment for pressure readout or control.

Sensor technology

The 974B transducer contains three separate sensor elements. The MicroPirani™ sensor element is based on measurement of thermal conductivity. The MicroPirani sensor consists of a silicon chip with a heated resistive element forming one surface of a cavity. A cover on top of the chip forms the other surface of the cavity. Due to the geometry of the sensor, convection cannot take place within the cavity and consequently the sensor is insensitive to mounting position. Gas molecules are passed by diffusion only to the heated element where the heat loss of the gas is measured.

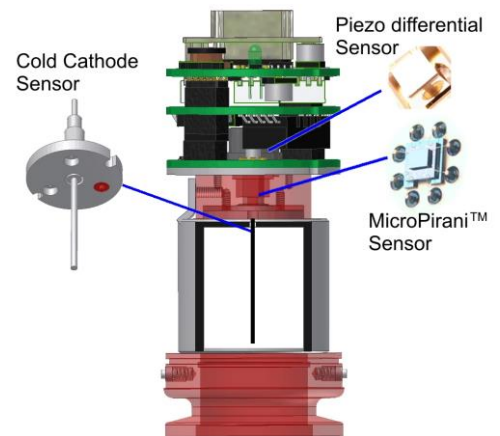

The cold cathode inverted magnetron utilizes a high voltage anode, cathode and a permanent magnet. Electrons are accelerated towards the anode and will ionize molecules by collision. The magnetic field deflects the electrons, causing them to spiral as they move across the magnetic field to the anode. This spiraling movement increases the opportunity for them to encounter and ionize the molecules. The ionization of the molecules creates an electric current as a function of the pressure.

The Piezo sensor is based on measurement of mechanical deflection of a silicon membrane where one side of the membrane is exposed to ambient pressure and the other side is exposed to vacuum. The Piezo measures true differential pressure independent of gas composition and concentration.

The 974B provides a fourth absolute sensor output based on the measurement made by the differential Piezo. This output is automatically calibration based on the MicroPirani measurement on every pump down cycle.

Applications

The 974B can be used in many different vacuum applications within the semiconductor, analytical and coating industries:

- Loadlock pressure controlling
- General vacuum and base pressure measurement
- Gas backfilling measurement and controlling
- Coating
- Mass spectrometer control
- System process control
- Sense abnormal pressure and take appropriate security measures using setpoint relays

Disposal (European Union only)

The 974B transducer is manufactured according to the RoHS directive.



For the benefit of the environment, at the end of life of the 974B, it should not be disposed in the normal unsorted waste stream. It should be deposited at an appropriate collection point or facility to enable recovery or recycling.



974B Functions

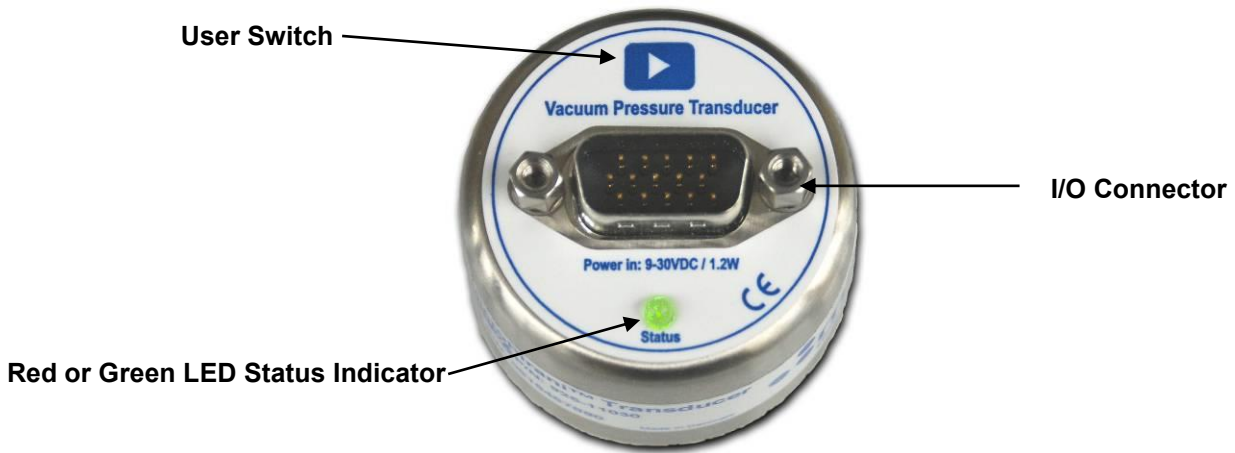

User Switch

The user switch has the following functions:

1. Vacuum Zero adjustment (VAC! Command)
2. MicroPirani Atmospheric adjustment (ATM! Command)
3. Transducer firmware upgrade mode

Refer to pages 21, 22 and 46 for operation procedure.



If the user switch is activated by accident and Vacuum Zero or Atmospheric adjustment is executed the original factory adjustment can be recovered using the FD!VAC or FD!ATM command. (See factory default page 24).

If the transducer is delivered with customer specified parameters the User Switch is disabled. For enabling the switch see page 25.

LED Status Indicator

The red/green LED status indicator has the following stages:

- | | |
|-------------------------------|--|
| 1. GREEN | Normal operation |
| 2. 2 sec. RED | Power on sequence |
| 3. GREEN 1 sec. flash cycle | Test mode TST!ON see page 25 |
| 4. GREEN 0.5 sec. flash cycle | Cold Cathode high voltage turned on |
| 5. Red 0.5 sec. flash cycle | Cold Cathode high voltage turned on, but ionization has not started. |
| 6. 3 x GREEN flash | User Adjustment executed successfully |
| 7. 3 x RED flash | User Adjustment failed |
| 8. RED | MicroPirani sensor failure (see page 17) |
| 9. OFF | Firmware upgrade mode (see page 52) or Power off |

Transducer installation (mechanical)



Do not use or install the 974B transducer where the following conditions occur:

- Temperatures lower than 0 °C or higher than 40 °C
 - Corrosive or explosive gases
 - Direct sunlight or other heat sources
 - Magnetic fields
-

Process compatibility

The 974B transducer is intended for use in relatively clean environments. The transducer cannot be used in corrosive environments like a semiconductor etch process chamber where aggressive gases such as fluorine are used.

If the 974B transducer is located close to a gas source connection like a flow controller or leak valve the transducer pressure measurement can be higher than the actual chamber pressure. Location close to a pumping system connection can cause a lower pressure measurement than actual chamber pressure.

The 974B transducer and its sensor design can be mounted in any orientation without compromising accuracy.

Explosive Environments

The 974B should not be used in explosive environments, due to its high voltage potential that can cause ignition.

Temperature

The 974B has an active and individual sensor temperature compensation circuit that ensures accurate measurement in a wide temperature range. For best measuring performance avoid large temperature gradients and direct cooling like air-condition air stream or direct heating like a pump exhaust stream.

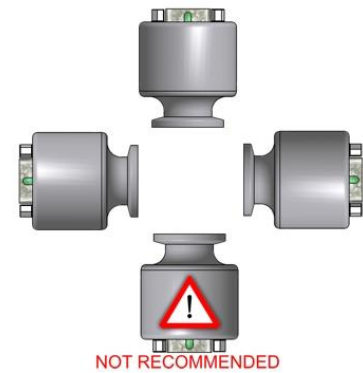

Bake out

The transducer electronics can withstand 85 °C (185 °F) when the power is turned off.

Contamination

Locate and orient the 974B where contamination is least likely. The MicroPirani sensor has a low filament temperature of only 35 °C above ambient temperature; therefore, the MicroPirani is less prone to contamination by cracking products from fore vacuum pump oil.



If the transducer is backfilled with a liquid (like pump oil) the sensor element is likely permanently damaged. The transducer cannot be cleaned using solvents.

Vibrations and instant air inrush

The 974B sensor elements are extremely robust to mechanical forces like vibration and G-forces. The sensor element cannot be damaged by fast and repeated pressure cycles or instant inrush of air.

Vacuum connections

The 974B transducer is available with different types of vacuum fittings. When mounting the transducer always ensure that all vacuum sealing items and surfaces are clean, without damage and free of particles. Do not touch the vacuum flange sealing surface.



If the transducer will be exposed to pressures above atmospheric pressure make sure that proper vacuum fittings are used. Ensure that the internal system pressure is at ambient pressure conditions before opening the vacuum system and removing any connections.

Pressure range

The standard 974B transducer is internally sealed with elastomer viton sealing for use down to 1×10^{-8} Torr. The 974B can be exposed to positive pressure up to 3000 Torr absolute.

Transducer installation (electrical)

The 974B is available with different input/output connectors. Use a cable with strain relief to ensure proper electrical connection and to reduce stress on the connectors.



Ensure a low impedance electrical connection between the 974B transducer body and the grounded vacuum system to shield the sensor from external electromagnetic sources.

Ensure that the analog output is connected to a floating input.

To comply with EN61326-1 immunity requirements, use a braided shielded cable. Connect the braid to the metal hoods at both ends of the cable with the end for power supply connected to earth ground.

The power supply input is 9 to 30 VDC. The power supply input is protected by an internal thermal fuse. The fuse is self recoverable; do not replace it. Damage may occur to the circuitry if excessive voltage is applied, polarity reversed or if a wrong connection is made.

If using the analog voltage output, connect the positive analog out and negative analog out pins to a differential input voltmeter or an analog-to-digital (A/D) converter. Do not connect the negative side of the analog output to the negative side of the power supply input or to any other ground. Doing so will cause half of the power current to flow through this wire. Measurement errors in the output voltage may be seen due to the voltage drop from this current. The longer the cable, the worse the error will be. Do not connect the setpoint relay terminals to the analog output.

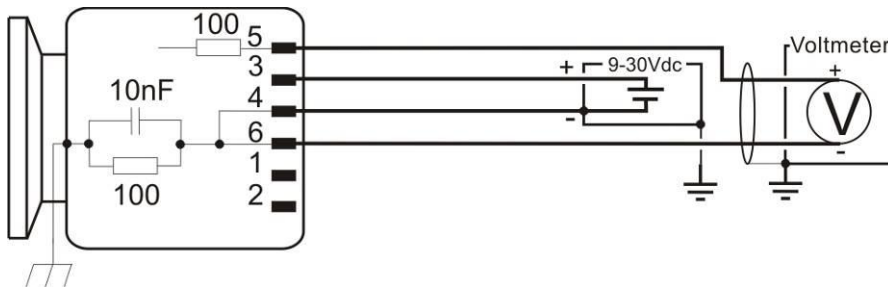

Correct connection of analog output to floating input

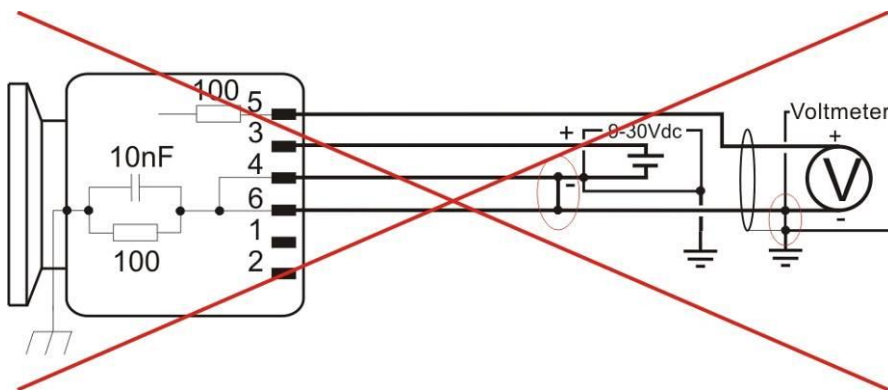

Incorrect connection of analog output to none floating input

Input/Output Wiring

974B I/O Connector (15 pin)

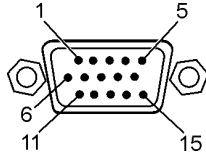

15 pin male HD DSUB

PIN	Description
1	RS485- / RS232 Transmit
2	RS485+ / RS232 Receive
3	Power + (9-30 VDC)
4	Power return -
5	Analog Output +
6	Analog Output -
7	Relay 1, Normally Open
8	Relay 1, Common
9	Relay 1, Normally Closed
10	Relay 2, Normally Closed
11	Relay 2, Common
12	Relay 2, Normally Open
13	Relay 3, Normally Closed or Analog Out 2 (Hardware option)
14	Relay 3, Common
15	Relay 3, Normally Open

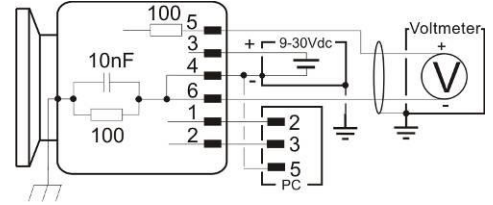

974B I/O Connector (6 pin Hirschmann)



PIN	Description
1	Identification resistor (11.1K/ 9.1K High voltage on)
2	Analog Output +
3	Analog Output -
4	Power + (9-30 VDC)
5	Power return -
6	Chassis

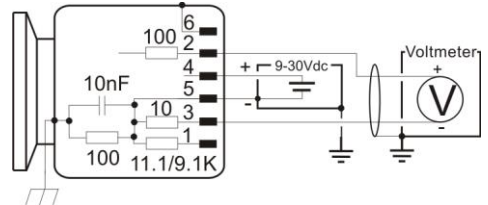

974B I/O Connector (8 pin RJ45/FCC68)

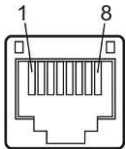

PIN	Description
1	Power + (9-30 VDC)
2	Power return -
3	Analog Output +
4	Identification resistor (1)
5	Analog Output -
6	Setpoint output
7	Not Connected
8	Not Connected

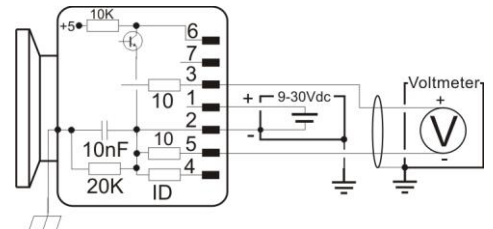

(1) Identification resistor varies with part number:

Part number	Value
974B-x1380	75K
974B-x1580	85K

974B RS232 connector (6 pin Hirschmann + 8 pin RJ45/FCC68)

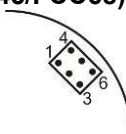

PIN	Description
1	RS232 Transmit
2	RS232 Ground
3	RS232 Receive
4	RS232 Receive
5	RS232 Ground
6	RS232 Transmit

P/N: 10001367

RS232 Cable for Hirschmann and RJ45/FCC68 Transducers.

Serial user interface

The 974B is as standard supplied with RS232 or RS485 user interface. The user interface allows change of transducer parameters such as setpoint settings and calibration. The serial interface uses the following data format: 8 data bits, 1 stop bit and no parity bit.

RS232 user interface

The 974B is DCE (Data Communication Equipment) and can be connected to DTE (Data Terminal Equipment), typically a PC. The serial communication does not use hardware handshake. The RS232 standard does not specify the maximum cable length, but length depends on environment, cable quality and communication speed. In general cable spans shorter than 15m (50ft.) do not require any extra precautions.

The RS232 connection on transducers delivered with 6 pin Hirschmann and 8 pin RJ45/FCC68 connector is available at a separate connector. Refer to Accessories and Replacement part number page 61 for RS232 programming cable. The connector is located under the label on the top of the transducer.

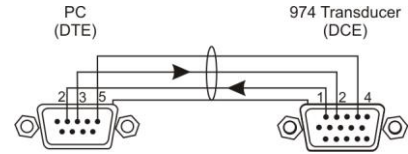

RS485 user interface

RS485 is a network communication system that enables the user to communicate with several units on the same communication line. RS485 is a balanced communication system, because signal on one wire is ideally the exact opposite of the signal on the second wire. Compared to RS232 communication RS485 allows significantly longer cable span. The maximum length of cable span depends on the environment, cable quality and communication speed, but relative long cable spans up to 1,200m (4,000 ft.) is possible.

There are 2 wires other than ground that are used to transmit the digital RS485 signal. The 974B uses half duplex communication.

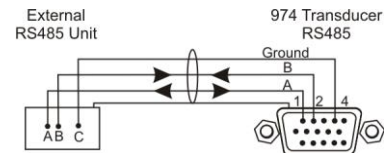

Always use high quality shielded data cables for serial communication. For long cable runs use twisted pairs. See also Accessory and Replacement part number page 61.

The EIA-485 and NMEA standards specification states that signal A is the inverting “-” and signal B is the non inverting or “+”. This is in conflict with the A/B naming used by a number of different transceiver manufacturers which is incorrect, but their practice is used throughout the industry. Therefore care must be taken when using A/B naming. In addition to the A and B connections, the EIA standard also specifies a third interconnection point called C, which is the common ground.

At high communication baud rates and when using long cable runs, a termination resistor of typical 120 Ohm should be connected between pin 1 and 2 at the 974B DSUB connector and between pin A and B at the data communication equipment. The termination resistors provides low impedance that reduces the sensitivity to electrical noise and prevents data reflection that can cause data communication corruption.

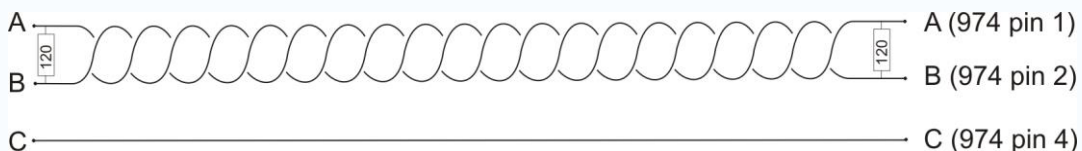

RS485 twisted pair cable run with 120 Ω terminator resistors (974B with 15 pin connector)



When connecting multiple devices in a RS485 network make sure that proper guidelines and specifications are followed to ensure optimal communication performance of the 974B. Improper network design can cause data communication interruption and data collision.

Communication Protocol

The 974B transducer command set allows the user to change transducer parameters and receive pressure measurements. Settings and parameters like setpoint values, setpoint configurations and calibration data are stored in the transducers non volatile memory.

Communication software

Communication software is required to communicate from PC via RS232/485 interface to the transducer. In the standard Microsoft Windows package the hyper terminal software can be used to type and transmit serial commands to the transducer. To the right is illustrated the Windows communication port properties for communicating with transducer factory default settings. MKS also offers communication software examples that can be downloaded at: www.mksinst.com/vtsw/

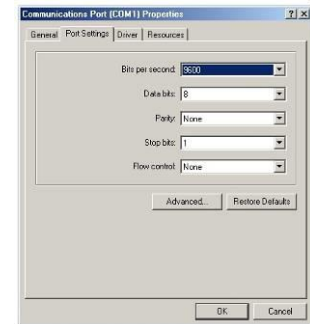

In OEM applications transducer communication software routines are normally integrated with other system control software.

Query and Command Syntax

Queries return current parameter settings; commands change the parameter setting according to the value the user enters into the command syntax. Each query or command must begin with the attention character @ and end with the termination ;FF.

Command syntax for an information query:

@<device address><query>;FF

Command syntax for a command:

@<device address><command>!<parameter>;FF

The command set allows upper and lower case ASCII characters.

Response Syntax (ACK/NAK)

The ASCII characters 'ACK' or 'NAK' preface the query or command response string. The ACK sequence signifies the message was processed successfully. The NAK sequence indicates there was an error.

The response to a query or a successful command is:

@<device address>ACK<data>;FF

The response to a message with an error is:

@<device address>NAK<NAK code>;FF

Examples:

ACK response: @253ACK9600;FF (baud rate changed to 9600)

NAK response: @253NAK160;FF (command had an error—possible typo)

The following list provides descriptions of the NAK codes that may be returned.

NAK Code	Error description	Example
8	Zero adjustment at too high pressure	@253VAC!;FF
9	Atmospheric adjustment at too low pressure	@253ATM!7.60;FF
160	Unrecognized message	@253S%;FF
169	Invalid argument	@253EN1!of;FF
172	Value out of range	@253SP1!5.00E+9;FF
175	Command/query character invalid	@253FV!;FF
180	Protected setting (locked)	-
195	Control setpoint enabled (ENC)	@253FP!ION;FF

Baud rate

The baud rate represents the communication speed. The 974B supports 4800, 9600, 19200, 38400, 57600, 115200 and 230400 baud rates. The transducer is always delivered with 9600 bps factory default baud rate.

Change of Baud rate:

Command:	@253BR!19200;FF
Command values:	4800, 9600, 19200, 38400, 57600, 115200, 230400
Command reply:	@253ACK19200;FF
Factory default:	9600

The transducer will reply in the current baud rate and then change to the new value.

Addressing

The transducer uses an addressable communication protocol that allows multiple MKS 900 Series transducer devices to be connected in a RS485 network. The address is required in both RS232 and RS485 communication.

The address can be set from 001 to 253. Address 254 and 255 are universal addresses, which can be used to broadcast a command to all devices on the network. Commands sent with address 254 will be executed by all transducers on the network and all transducers will transmit a reply. Commands sent with address 255 will be executed by all transducers on the network, but the transducers will not transmit replies. For example, use address 254 to communicate with a device if its address is unknown.

Change of Address:

Command:	@253AD!123;FF
Command values:	001 to 253
Command reply:	@253ACK123;FF
Query:	@254AD?;FF
Query reply:	@253ACK253;FF
Factory default:	253

Communication delay (RS485)

The 974B half duplex RS485 interface requires that data is transmitted and received on the same communication line. Some RS485 transceiver equipment have a settling time when changing from transmit to receive mode. If the transducer replies too fast the first character(s) will not be received as the following example illustrates:

Sending pressure request:	@254PR1?;FF
Receiving data:	23E-4;FF (Correct data: @253ACK1.23E-4;FF)

The RS delay introduces a baud rate dependent delay between receive and transmit sequence to prevent loss of data in the receiving string.

Communication delay:

Command:	@253RSD!ON;FF
Command values:	ON, OFF
Command reply:	@253ACKON;FF
Query:	@253RSD?;FF
Query reply:	@253ACKON;FF
Factory default:	ON

Setpoint relays

The 974B can be ordered with 3 mechanical relays that can be used for controlling external process equipment. The relay has closing and breaking contacts and the contacts are rated 30 VDC, 1A resistive load.

If the transducer is supplied without setpoint relays, the setpoint commands can still be accessed. Refer to part number definition page 3 to verify if setpoint relays are included.

Inductive relay load

Special precautions should be taken when driving inductive loads at the relay contact. When an inductive load like a solenoid is energized, the in-rush current is significant higher than the regular load current. In-rush currents exceeding the relay contact rating can cause reduction of relay contact life time or contact reliability. When a solenoid is de-energized, the collapsing magnetic field can cause significant voltage spikes. These spikes can couple capacitive from cable to cable and interfere with measuring electronics or transducer signal.



Driving inductive loads via the setpoint relay contacts requires de-energizing spike protection. Inadequate protection can cause permanent damage to the transducer or interfere with the analog output signal. Always ensure that inductive inrush currents do not exceed relay contact rating.

An arc suppression network as shown schematically to the right is recommended. The values of the capacitance C and the resistance R can be calculated by the following equations:

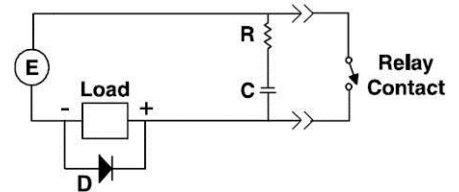

$$C = I^2 / (1 \times 10^7) \quad R = E / I^a$$

where:

C is in Farad. R is in Ohm

I is DC or AC_{peak} load current in Ampere. E is DC or AC_{peak} source voltage in Volt

$$a = 1 + (50/E)$$

Note that $R_{min} = 0.5 \Omega$ and $C_{min} = 1 \times 10^{-9} \text{ F}$. D is a fast transient suppression diode.

PDR900 controller relays

The PDR900 controller has power relays that can drive higher current loads and voltages than the transducer relays. If the transducer is used with the PDR900 controller refer to PDR900 manual for setup of relay output.



Do not connect any external sources to the transducer relay pins when using it together with the PDR900 controller. Always use the PDR900 relay outputs.

Setpoint functionality

The setpoint relays can be activated either above or below the setpoint values. The graphs below show the different relays stages in either below or above configuration. The NC contact will always be closed in case of power failure.

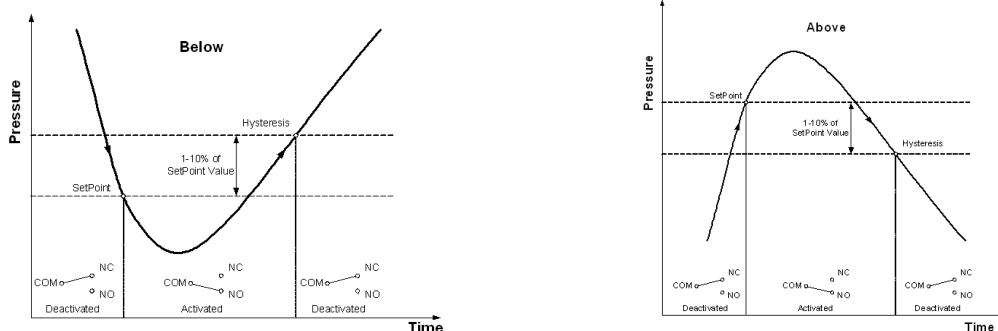



When using the setpoint relay to control process equipment, always take appropriate precautions to prevent system damage in case of transducer power failure. The NC contact will be closed in case of transducer power failure.



If the transducer is supplied as a special version (P/N: 974B-xxxxx-xxxx) with pre-configured parameters such as setpoint settings, the setup is per default locked. The transducer will reply with error code "NAK180" if the user tries to change parameters. To change pre-configured parameters refer to unlock procedure page 25.

Setpoint setup by Serial interface

The correct procedure for setting up setpoint parameters are:

1. Enter setpoint value 5.00E+1 Torr
Command: @253SP1!5.00E+1;FF
Reply: @253ACK5.00E+1;FF
2. Select setpoint direction (ABOVE/BELOW)
Command: @253SD1!BELOW;FF
Reply: @253ACKBELOW;FF
3. Enter setpoint hysteresis value, if other than default +/- 10% of setpoint value is required.
Command: @253SH1!4.00E+1;FF
Reply: @253ACK4.00E+1;FF
4. Enable setpoint (OFF, CMB, PIR, PZ, CC)
Command: @253EN1!CC;FF
Reply: @253ACKCC;FF

Setpoint setup by PDR900 Controller

1. Edit > Setpoint > Setpoint 1 > Setpoint Value 1
Enter setpoint value 5.00E+1 Torr

Enter pressure +5.00E+1 Torr

2. Edit > Setpoint > Setpoint 1 > Direction 1
Select setpoint direction

Direction 1 BELOW

3. Edit > Setpoint > Setpoint 1 > Hysteresis 1
Enter setpoint hysteresis value
Only if other than default +/- 10% of setpoint value is required.

Enter pressure +6.00E+1 Torr

4. Edit > Setpoint > Setpoint 1 > Enable 1
Enable setpoint

Enable 1 CMB

Setpoint value

The setpoint value is the pressure either below or above which the setpoint relay will be energized.

Setpoint hysteresis value

The hysteresis value is the pressure value at which the setpoint relay will be de-energized.

Setpoint direction

The setpoint direction determines whether the relay is energized above or below the setpoint value.

Enable setpoint

The enable setpoint command enables, disables or assigns the setpoint relay to either the combined reading (CMB), the Cold Cathode (CC) or MicroPirani measurement (PIR).



The 974B transducer has an auto hysteresis setting of 10% of the setpoint value that overwrites the current hysteresis value whenever the setpoint value or setpoint direction is changed. If other hysteresis value than 10% is required, first set the setpoint value and setpoint direction before setting hysteresis value.

Setpoint safety delay

The setpoint safety delay function requires 5 continuously measurements that exceeds setpoint value before the relay is tripped. This feature prevents that noise or pressure pulse can trig the relay. If fast setpoint response is required the setpoint safety delay can be disabled.

Setpoint safety delay

Command: @253SPD!ON;FF
 Command values: ON, OFF

Command reply: @253ACKON;FF
 Query: @253SPD?;FF
 Query reply: @253ACKON;FF
 Factory default: ON

Display

The 974B with integrated display provides real time pressure readout, pressure trend and setpoint status. The display setup can be changed via the intuitive menu interface. The settings menu views transducer settings.

Use the [▲] and [▼] keys to scroll the cursor and select menu point by pressing the [+] key.

Sensor: Select MicroPirani (PIR), Piezo (PZ), Cold Cathode (CC) or combined reading
 Unit: Select pressure unit Torr, mbar or Pascal. (Will not change transducer unit setup)
 Orientation: Select display orientation
 Settings: View transducer parameters



Main menu



Unit selection



View Settings

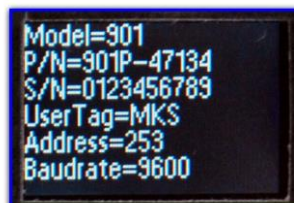

Pressure output

The 974B transducer can provide pressure measurement output as an analog voltage or RS232/RS485 digital value. The digital value is 3 digits scientific notation for PR1, PR3, PR5 reading and 4 digits for PR4 reading.

Pressure request:

Query: @253PR1?;FF
 Query reply: @253ACK1.23E-4;FF

Pressure outputs:

PR1: MicroPirani sensor reading
 PR2: Piezo sensor differential reading
 PR3: MicroPirani, Cold Cathode, Piezo abs. combined reading
 PR4: MicroPirani, Cold Cathode, Piezo abs. combined reading (4 digits)
 PR5: Cold Cathode reading

The default analog output is based on the combined PR3 reading and provides a 16 bit voltage output of 0.5 VDC/decade (standard configuration). Refer to Analog output page 27 for details.



If ionization does not ignite the combined output will provide the MicroPirani measurement until valid ignition is detected.

Combined reading PR3 and PR4

The PR3, PR4 and the analog output combines Cold Cathode, Piezo and MicroPirani reading into one smooth pressure reading with accurate measuring performance throughout the entire pressure range of 11 decades.

The combined PR3 and PR4 provide a normalized absolute pressure measurement based on the Piezo differential sensor. When the transducer is powered on for the first time, the combined output will read 760 Torr (normal sea level pressure) at Zero differential pressure regardless of the actual absolute ambient barometric pressure. The ambient atmospheric pressure varies with weather and elevation of the location where the transducer is used. When the transducer is pumped down below 1.2 Torr the transducer can determine the ambient pressure by reading and normalizing the differential Piezo output with reverse sign. The transducer will automatically calibrate the Piezo absolute reading when the transducer is pumped below 1.2 Torr. If the calibration deviates more than +/- 10 Torr from the current calibration value the calibration is stored in the nonvolatile memory. When the transducer is vented back to ambient pressure the combined output PR3 and analog output will read the correct ambient pressure.

PR3/PR4 combined reading measurement

Gas setup	PR3/PR4 MicroPirani, CC reading	PR3/PR4 MicroPirani /Piezo absolute integration	PR3/PR4 Piezo absolute Reading
Nitrogen, Air, Neon, CO ₂ , Xenon: (MP)	<40 Torr	40-60 Torr	>60 Torr
Hydrogen: (PZabs)	<5 Torr	5-7 Torr	>7 Torr
Argon, Helium, H ₂ O: (PZabs)	<7 Torr	7-10 Torr	>10 Torr

The MicroPirani automatically turn on the Cold Cathode at 5E-4 Torr (SLC) and turn it off at 8E-4 Torr (SHC). Above 4E-4 the combined reading is the MicroPirani pressure measurement and below 1E-4 Torr it is the Cold Cathode pressure measurement. Between 1E-4 and 4E-4 Torr the two measurements are smoothly integrated.

The PR3 reading provides 3 digits resolution and the PR4 reading provides 4 digits resolution.

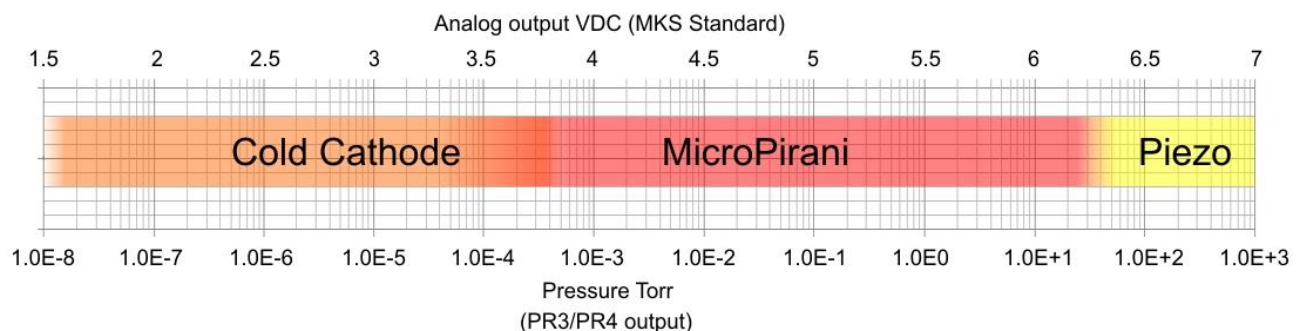

Cold cathode integration

SLC: Low CC turn on pressure (5.0E-4 Torr)
 SHC: High CC turn off pressure (8.0E-4 Torr)
 SLP, Low CC/MP integration (1.0E-4 Torr)
 SHP, High CC/MP integration (4.0E-4 Torr)

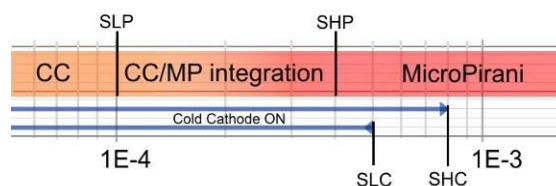

In some application it is preferred not to have the Cold Cathode (high voltage) turned on during vacuum process or during mass spectrometer analyzing. The 974B Cold cathode turn on pressure (SLC) and turn off pressure (SHC) can be changed by the user. Furthermore the high and low integration levels between the Cold Cathode reading and MicroPirani reading can be changed by the user.



When designing external pressure control loops, make sure that external equipment like pumping system is not damaged if the transducer output enters Sensor defect mode page 17 or in case of power failure.



When designing pressure data collecting software and controlling loop, make sure that the software does not interpret a communication error as a valid pressure value.

Cold Cathode ignition startup

When the Cold Cathode high voltage is enabled, automatically by the MicroPirani or manually, an ignition delay may occur. The ignition waiting time is from less than a second at high pressures to minutes at low pressures. The ignition time is a function of gas density, cleanness of the gauge and presence of any other ion sources in the system.

The combined analog output and PR3, PR4 reading provides the MicroPirani reading until ignition has occurred and valid Cold Cathode measurements is present. When the Cold Cathode is enabled, but ionization not ignited the LED will flash red. The LED will flash green when valid measurements are present.

Pressure	Typical ignition time
1.00E-8 Torr	≈12 Minutes
1.00E-6 Torr	≈10 Seconds
1.00E-4 Torr	≈1 Second

Resolution

The digital pressure output can provide 3 digit or 4 digit values; however, the resolution is limited in certain parts of the measuring range.

Piezo:		
-8.00E+2 to +8.00E+2 Torr	2 digit resolution	-1.23E+2
MicroPirani:		
1.00E-5 to 1.00E-4 Torr	1 digit resolution	1.000E-5
1.00E-4 to 1.00E-3 Torr	2 digits resolution	1.200E-4
1.00E-3 to 900 Torr	3 or 4 digits resolution	1.234E-3
Cold Cathode:		
1.00E-7 to 1.00E-8 Torr	2 digits resolution	1.50E-8
5.00E-3 to 1.00E-7 Torr	3 digits resolution	1.230E-4

Measuring noise

External sources can interfere with the sensor signal and cause noise in the signal. The low measuring range is most sensitive to measuring noise due to low signal levels.

Magnetic interference

External magnetic sources can interfere with the Cold Cathode sensor and cause measurement deviation from actual pressure. Avoid having magnetic material located close to the 974B Transducer.

Cold Cathode pressure dose

The Cold Cathode pressure dose continuously monitors the Cold Cathode time on as function of the pressure. If the cold cathode is on for 100 hours at 1E-4 Torr the pressure dose is $100 \times 1E-4 = 1E-2$ Torr hours. The pressure dose readout can be used to determine the time interval between Cold Cathode maintenance and service.

Pressure dose request:

Query: @253TIM3?;FF
Query reply: @253ACK1.23E-4;FF



The pressure dose reading is only a rough indication of the cold cathode status. When the cold cathode is contaminated the sensitivity of the gauge is decreased and it will provide a lower reading than actual pressure. Therefore the calculated pressure dose can be lower than the actual pressure dose.

Cold Cathode pressure dose setpoint

The Cold Cathode pressure dose setpoint provides an indication when a defined pressure dose is exceeded. The transducer status query will provide "R" when pressure dose is exceeded.

Pressure dose setpoint command:

Command: @253PD!1.00E-2;FF
Command values: 1.00E-6 to 100

Command reply: @253ACK1.00E-2;FF
Query: @253PD?;FF
Query reply: @253ACK1.00E-2;FF
Factory default: 1.00E+00 Torr
Value out of range: @253NAK172;FF

Cold Cathode setup

The 974B can be configured to the process and application by individually programming of the cold cathode turn on and off pressure and pressure settings for MicroPirani integration.

Cold cathode auto turn on and off

The 974B has a control setpoint for turning the cold cathode on and off. The SLC command sets the turn on pressure and SHC command sets the turn off pressure.

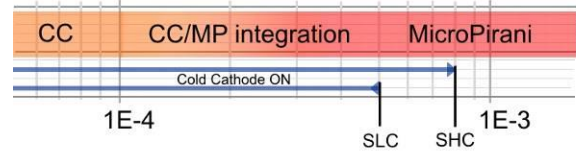

If the Cold Cathode control setpoint is disabled, the sensor control must be executed manually with the FP command. Operation of the cold cathode at higher pressure than 1E-3 Torr can cause loss of measurement performance. The cold cathode will always turn off automatically at pressure higher than 5.0E-3 Torr.

If the SLC and SHC value are too close the Cold Cathode can turn off immediately after turning on.

Cold cathode turn on pressure (Only if ENC is ON)

Command: @253SLC!1.00E-4;FF
Command values: 1.00E-4 to 5.00E-3

Command reply: @253ACK1.00E-4;FF
Query: @253SLC?;FF
Query reply: @253ACK5.00E-4;FF
Factory default: 5.00E-4 Torr
Value out of range: @253NAK172;FF

Cold cathode turn off pressure (Only if ENC is ON)

Command: @253SHC!8.00E-4;FF
Command values: >SLC (turn on pressure) or 1.00E-4 to 5.00E-3

Command reply: @253ACK8.00E-4;FF
Query: @253SHP?;FF
Query reply: @253ACK8.00E-4;FF
Factory default: 8.00E-4 Torr
Value out of range: @253NAK172;FF

Cold cathode / MicroPirani smoothing

The combined output (PR3) switches automatically between the MicroPirani and Cold Cathode sensor. The high and low switch value can be set and should correspond to the cold cathode turn on and off pressure.

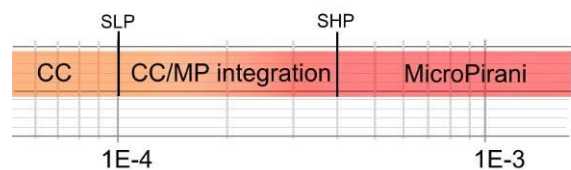

Sensor smoothing low value

Command: @253SLP!1.00E-4;FF
Command values: 1.00E-4 to SHP (turn off pressure)

Command reply: @253ACK1.00E-4;FF
Query: @253SLP?;FF
Query reply: @253ACK1.00E-4;FF
Factory default: 1.00E-4 Torr
Value out of range: @253NAK172;FF

When setting the turn on value, the turn off value is automatically set to 30% higher than the low value.

Sensor smoothing high value

Command: @253SHP!8.00E-4;FF
Command values: 1.00E-4 to 5.00E-3

Command reply: @253ACK8.00E-4;FF
Query: @253SHP?;FF
Query reply: @253ACK4.00E-4;FF
Factory default: 4.00E-4 Torr
Value out of range: @253NAK172;FF

Cold Cathode control setpoint

The cold cathode control setpoint automatically turn on the Cold Cathode high voltage when the MicroPirani pressure is lower than the SLC value.

Command: @253ENC!ON;FF
Command values: ON, OFF

Command reply: @253ACKON;FF
Query: @253ENC?;FF
Query reply: @253ACKON;FF
Factory default: ON

Cold Cathode protect setpoint

The Cold Cathode protect setpoint automatically turns off the Cold Cathode high voltage if the cold cathode measurement exceeds 5.00E-3 Torr for 120 seconds. The protect setpoint can be turned off (disabled) or time set between 0 and 999 seconds.

Command: @253PRO!ON;FF
Command values: ON (120), OFF, 0 to 999 seconds

Command reply: @253ACK120;FF
Query: @253PRO?;FF
Query reply: @253ACK120;FF
Factory default: OFF

Cold Cathode power

If the Cold Cathode control setpoint is disabled (OFF) then the Cold Cathode high voltage can be manually controlled by the FP command.

Command: @253FP!ON;FF
Command values: ON, OFF

Command reply: @253ACKON;FF
Query: @253FP?;FF
Query reply: @253ACKOFF;FF
Factory default: OFF
ENC is ON: @253NAK195;FF

If Cold Cathode control setpoint (ENC) is on, the Cold Cathode power cannot be controlled manually.

Calibration and adjustment

The 974B is factory calibrated when delivered and in many applications further calibration is not required. If the sensor element has been contaminated or damaged by process gases, adjustment of zero and full scale can be executed to compensate for small measurement errors.



The 974B is per factory default calibrated for reading in Nitrogen gas. When exposed to atmospheric air the MicroPirani sensor (PR1) will read higher values, typically 900 Torr at ambient pressure.

Accuracy and repeatability

The 974B measuring accuracy is specified as transducer reading \pm a percentage of the actual pressure. The basic measuring accuracy is factory calibrated and cannot be user adjusted. The repeatability specification is the transducers ability to repeat the same measurement value after multiple pressure cycles. Refer to the transducer specification page 58 for actual values.

Gas calibration

The 974B is based on measurement of thermal conductivity and ionization of the gas and consequently its reading depends on the gas type and concentration. The factory default setting is Nitrogen calibration; however, the transducer has MicroPirani calibration curves for several common gases.

Change of gas calibration setup:

Command:	@253GT!ARGON;FF
Command values:	NITROGEN, AIR, ARGON, HELIUM, HYDROGEN, H2O, NEON, CO2, XENON
Command reply:	@253ACKARGON;FF
Query:	@253GT?;FF
Query reply:	@253ACKARGON;FF
Factory default:	NITROGEN

Pressure unit calibration

The transducer can provide digital and analog output in Torr, mbar and Pascal pressure units. When changing pressure unit all parameters such as setpoint settings are automatically converted to the new unit, so it will represent the same pressure level. All pressure parameters such as setpoint settings and calibration values must be entered in the actual transducer unit setting.

Change of pressure unit calibration setup:

Command:	@253U!PASCAL;FF
Command values:	TORR, MBAR, PASCAL
Command reply:	@253ACKPASCAL;FF
Query:	@253U?;FF
Query reply:	@253ACKTORR;FF
Factory default:	TORR

The Torr unit is most common in the US and mbar is most common in Europe. Pascal is the official pressure unit as specified by SI (from the French *Le Système International d'Unités*) and is widely used in Asia.

MicroPirani™ Auto Zero limit Adjustment (MZL)

The MicroPirani will be zero adjusted whenever the pressure measured by the Cold Cathode is lower than 8E-6 Torr (MZL). For applications that do not go below 8E-6 Torr the MicroPirani auto zero limit can be set to higher pressure.

Change of pressure auto zero limit:

Command:	@253MZL!1.00E-4;FF
Command values:	1.00E-6 to 5.00E-4
Command reply:	@253ACK1.00E-4;FF
Query:	@253MZL?;FF
Query reply:	@253ACK1.00E-4;FF
Reset to default:	@253FD!MZL;FF
Factory default:	1.00E-4 Torr
Value out of range:	@253NAK172;FF

MicroPirani Zero Adjustment by serial interface

The zero adjustment function changes the MicroPirani measurement offset at low pressure. Temporary or permanent shift in zero offset can be caused by contamination, corrosion, electrical noise interference and temperature.



Zero adjustment only changes the low measuring range and will have no influence on measuring errors in the range from 1×10^{-2} and above.

If the transducer is reading 8.00E-5 Torr at an actual pressure of 1.00E-5 Torr, the offset error is +7.00E-5 or 700% error of actual pressure. At two decades higher pressure of 1.00E-3 Torr the same offset error is a factor 100 lower. At 1.00E-3 Torr an offset error of 7.00E-5 Torr is equivalent to a 7% error.



To obtain best measuring performance, the transducer should be evacuated to a pressure below 8×10^{-6} Torr before executing zero adjustment. Zero adjustment can be executed at higher pressures, but this can cause inaccurate reading below the zero adjustment value.

Executing zero adjustment. (Evacuate the transducer to a pressure below 8×10^{-6} Torr or enter the zero pressure)

Command:	@253VAC!5.00E-5;FF
Command values:	None, < 3.00E-3
Command reply:	@253ACK;FF
Query:	@253VAC?;FF
Query reply:	@253ACK0.00E+00;FF
Reset to default:	@253FD!VAC;FF
Factory default:	<i>Factory adjustment value</i>
Value out of range:	@253NAK172;FF

After execution of zero adjustment the PR1 reading will be 1×10^{-5} Torr. If the pressure measured by the transducer is higher than approximately 1×10^{-2} Torr then the zero adjustment cannot be executed. This indicates that the transducer is contaminated and should be serviced. See page 56 for Service and Repair procedures.

The query feature reads the delta value between the user offset value and factory default value. This can be used to monitor the positive and negative offset trend regardless of how many times the zero adjustment is executed.

Zero Adjustment by use of the User switch

The transducer can also be adjusted by activating the user switch. When using the switch the transducer must be evacuated to a pressure below 8×10^{-6} Torr. Press down the switch for 2 seconds and the LED will flash green three times to acknowledge the zero adjustment has been executed successfully. The LED will flash red three times if the adjustment has failed.

MicroPirani Atmospheric adjustment

The MicroPirani atmospheric adjustment allows the user to adjust the MicroPirani full scale reading. Vent the transducer to atmospheric pressure using the gas that corresponds to the gas calibration setup. Atmospheric adjustment can only be executed with air or Nitrogen.



Atmospheric adjustment only changes the high measuring range and will have no influence on measuring errors in the range below 10 Torr.

Executing atmospheric adjustment. (Vent transducer to Nitrogen or air pressure of 500-780 Torr)

Command: @253ATM!7.60E+2;FF
Command values: 4.00E+2 to 8.00E+2

Command reply: @253ACK7.60E+2;FF
Query: @253ATM?;FF
Query reply: @253ACK0.00E+0;FF
Reset to default: @FD!ATM;FF
Factory default: *Factory adjustment value*

The query feature reads the delta value between the user atmospheric adjustment value and the factory default value.

Cold cathode zero adjustment

The Cold Cathode zero adjustment allows the user to adjust the cold cathode zero reading.

Executing zero adjustment.

Evacuate the transducer to a base pressure below 1×10^{-6} Torr or enter the zero pressure by use of a calibrated reference gauge.

To obtain measuring performance the transducer should be evacuated to pressure below 5×10^{-8} Torr.



If the Cold Cathode zero adjustment is executed at high pressure, the measurement below the zero value can become unreliable. Always zero at the system base pressure.

Command: @253VAC3!2.00E-8;FF
Command values: 1.00E-6 to 1.00E-8 Torr

Command reply: @253ACK;FF
Query: @253VAC3?;FF
Query reply: @253ACK0.00E+00;FF
Reset to default: @253FD!VAC3;FF
Factory default: *Factory adjustment value*
Value out off range: @253NAK172;FF

Cold cathode full scale adjustment

The Cold Cathode full scale adjustment allows the user to adjust the cold cathode reading at high pressure.

Command: @253CFS!4.00E-3;FF
Command values: 1.00E-4 to 5.00E-3 Torr

Command reply: @253ACK;FF
Query: @253CFS?;FF
Query reply: @253ACK1.00E+00;FF
Reset to default: @253FD!CFS;FF
Factory default: *Factory adjustment value*
Value out off range: @253NAK172;FF

Piezo Atmospheric zero adjustment

The Piezo atmospheric adjustment allows the user to adjust zero offset error for the differential measurement.

Executing Piezo zero adjustment. (Place the transducer in atmospheric pressure)

Command: @253ATZ!;FF
Command values: None

Command reply: @253ACK;FF
Query: @253ATZ?;FF
Query reply: @253ACK5E-1;FF
Reset to default: @253FD!ATZ;FF
Factory default: *Factory adjustment value*
Sensor value too high: @253NAK8;FF

After execution of Piezo atmospheric zero adjustment the PR2 reading will be $\pm 1 \times 10^{-1}$ Torr.

Piezo Atmospheric zero adjustment by use of the switch

The Piezo atmospheric zero adjustment can also be adjusted by use of the user switch. Expose the transducer to atmospheric pressure and press down the User switch for 2 seconds and the LED will flash green three times to acknowledge the atmospheric adjustment has been executed successfully. The LED will flash red three times if the adjustment has failed.



Piezo absolute Atmospheric output adjustment

The Piezo atmospheric adjustment allows the user to adjust the absolute Piezo reading at zero differential pressure. The Piezo absolute output adjustment is automatically adjusted whenever the pressure measured by the MicroPirani is lower than 1.2 Torr. If the value deviates more than ± 10 Torr of the current value ATD value the ATD value will be overwritten in the non volatile memory.

Executing Piezo absolute output adjustment.

Command: @253ATD!;FF
Command values: 4.00E+2 to 8.00E+2
Command reply: @253ACK;FF
Reset to default: @253FD!ATD;FF
Factory default: *Factory adjustment value*
Sensor value to high: @253NAK8;FF

After execution of Piezo atmospheric zero adjustment, the PR3 reading will read the entered value at zero differential pressure.

Piezo differential full scale adjustment

The ATS command sets the full scale reading for the differential Piezo. Enter the applied pressure in the range from 100 to 760 Torr.

Executing Piezo differential full scale adjustment.

Command: @253ATS!1.00E+2;FF
Command values: 1.00E+2 to 7.60E+2
Command reply: @253ACK;FF
Reset to default: @253FD!ATS;FF
Factory default: *Factory adjustment value*
Sensor value to high: @253NAK8;FF

Factory default

The transducer is per factory default delivered with parameters and setup as listed below. If the transducer is delivered with customer preconfigured parameters the values are different than listed below and the parameters will be locked per default.

Communication parameters:

Description	Command	Parameter	FD!	FD!ALL
Address:	AD!	253	-	x
Baud rate:	BR!	9600	-	x
Communication delay:	RSD!	ON	-	x

Transducer parameters:

Description	Command	Parameter	FD!	FD!ALL
Test mode (LED flash):	TST!	OFF	x	x
User tag:	UT!	MKS	-	x
Setpoint 1 value:	SP1!	1.00E0	-	x
Setpoint 1 hysteresis value:	SH1!	1.10E0	-	x
Setpoint 1 direction:	SD1!	BELOW	-	x
Setpoint 1 enable:	EN1!	OFF	-	x
Setpoint 2 value:	SP1!	1.00E0	-	x
Setpoint 2 hysteresis value:	SH1!	1.10E0	-	x
Setpoint 2 direction:	SD1!	BELOW	-	x
Setpoint 2 enable:	EN1!	OFF	-	x
Setpoint 3 value:	SP1!	1.00E0	-	x
Setpoint 3 hysteresis value:	SH1!	1.10E0	-	x
Setpoint 3 direction:	SD1!	BELOW	-	x
Setpoint 3 enable:	EN1!	OFF	-	x
Setpoint safety delay:	SPD!	ON	-	x
Switch enable:	SW!	ON	-	x
Analog out 1:	AO1!	30 ⁽¹⁾	-	x
Analog out 2:	AO2!	30	-	x
Cold Cathode turn on setpoint	SLC!	5.00E-4	-	x
Cold Cathode turn off setpoint	SHC!	8.00E-4	-	x
Cold Cathode control setpoint	ENC!	ON	-	x
Cold Cathode protect setpoint	PRO!	OFF	-	x
MP/CC Smoothing low limit	SLP!	1.00E-4	-	x
MP/CC Smoothing high limit	SHP!	4.00E-4	-	x
MicroPirani auto Zero limit	MZL!	1.00E-4	x	x

(1) If the transducer is delivered with other analog output than standard mks (part number specified), then the factory default value will be specified by the specials part number.

Calibration setup:

Description	Command	Parameter	FD!	FD!ALL
Gas calibration:	GT!	NITROGEN	x	x
MP Vacuum adjustment:	VAC!	<i>Factory adjustment value</i>	x	x
MP Span atmospheric adjustment:	ATM!	<i>Factory adjustment value</i>	x	x
CC Vacuum adjustment:	VAC3!	<i>Factory adjustment value</i>	x	x
CC full scale adjustment:	CFS!	<i>Factory adjustment value</i>	x	x
PZ atmospheric zero adjust:	ATZ!	<i>Factory adjustment value</i>	x	x
PZ positive full scale adjustment:	ATS!	<i>Factory adjustment value</i>	x	x
PZ absolute calibration:	ATD!	760 Torr	x	x
Pressure unit:	U!	TORR	-	x

Resetting to factory default

The factory default command resets all or certain parameters of the 974B to factory default settings as listed above. If other digital communication setup than factory default values are used, then the communication will be lost after execution of factory default and the transceiver equipment should be set to transducer values.



The factory default command resets parameters to default values and consequently user adjustments, setup and factory configured parameters are lost. Use with caution!

Command: @253FD!ALL;FF
 Command values: None, ALL, UNLOCK, LOCK, VAC, VAC3, ATM, CFS, ATD, ATS, ATZ, MZL
 Command reply: @253ACKFD;FF

Transducer lock function

To ensure that no unauthorized personal are able to change transducer setup and parameters, the transducer lock function can prevent direct access to parameter changes. Transducers delivered with pre-configured custom specified parameters (special part number) are per default locked and will reply with "NAK180", if the user tries to change locked parameters. The unlock procedure must be executed to change these parameters.

Disable lock function command:

Command: @253FD!UNLOCK;FF
Command reply: @253ACKFD;FF

Enable lock function command:

Command: @253FD!LOCK;FF
Command reply: @253ACKFD;FF

Standard transducer (7 digits part number: 974B-xxxx)
Factory default: *Transducer unlocked*

Special configuration transducer (11 digits part number: 974B-xxxx-xxxx)
Factory default: *Transducer locked*



If the transducer is delivered with special configuration, the lock function will only be temporarily disabled and will be enabled again after cycling power cycle or executing the enable lock command.



The 974B transducer can be delivered with factory locked tamperproof settings for safety interlock applications. This option is defined in the special settings. If delivered with factory lock the transducer settings can only be changed by return of gauge to MKS.

User Switch Command

The User Switch function can be disabled to prevent accidental execution of zero and atmospheric adjustments.

Command: @253SW!OFF;FF
Command values: ON,OFF

Command reply: @253ACKOFF;FF
Query: @253SW?;FF
Query reply: @253ACKON;FF
Factory default: ON

Transducer test

The transducer test command can be used to visually identify a transducer. If the test mode is enabled the LED will flash with a 1 sec. cycle.

Command: @253TST!ON;FF
Command values: ON,OFF

Command reply: @253ACKON;FF
Query: @253TST?;FF
Query reply: @253ACKON;FF
Factory default: OFF

Status Query Commands

Query replies are examples that might be different from actual transducer reply.

Device Type - DT

Specifies transducer device type name:

Query: @253DT?;FF
Query reply: @253ACKQUADMAG;FF

Firmware Version - FV

Specifies transducer firmware version:

Query: @253FV?;FF
Query reply: @253ACK1.27;FF

Hardware Version - HV

Specifies transducer hardware version:

Query: @253HV?;FF
Query reply: @253ACKA;FF

Manufacturer - MF

Specifies transducer manufacturer:

Query: @253MF?;FF
Query reply: @253ACKMKS;FF

Model - MD

Specifies transducer model number:

Query: @253MD?;FF
Query reply: @253ACK974B;FF

Part Number - PN

Specifies transducer part number:

Query: @253PN?;FF
Query reply: @253ACK974B-11030;FF

Serial Number - SN

Specifies transducer serial number:

Query: @253SN?;FF
Query reply: @253ACK0935123456;FF

Time ON - TIM

The TIM command returns the number of hours the transducer has been on:

Query: @253TIM?;FF
Query reply: @253ACK123;FF

Time ON 2 (Cold Cathode sensor) – TIM2

The TIM2 command returns the number of hours the cold cathode sensor has been on:

Query: @253TIM2?;FF
Query reply: @253ACK123;FF

Time ON 3 (Cold Cathode pressure dose) – TIM3

The TIM3 command returns the cold cathode pressure dose:

Query: @253TIM3?;FF
Query reply: @253ACK1.00E-2;FF

Temperature - TEM

The TEM command returns the MicroPirani on chip sensor temperature °C typical within ± 3 °C.

Query: @253TEM?;FF
Query reply: @253ACK2.50E+1;FF

Transducer Status – T

The T command returns the Transducer sensor status as O for OK, M for MicroPirani failure, C for Cold Cathode failure, Z for Piezo sensor failure, R pressure dose setpoint exceeded or G for Cold Cathode ON.

Query: @253T?;FF
Query reply: @253ACKO;FF

Analog output

The 974B transducer provides a voltage output as function of pressure.

The standard output is 0.5 VDC/decade but can also be configured to emulate other analog outputs.

Analog output calibration = 0 (MKS standard 0.5 VDC/decade)

$$P_{\text{Torr}} = 10^{(2 \times V_{\text{out}} - 11)}$$

$$V_{\text{out}} = \frac{\log_{10}(P_{\text{Torr}}) + 11}{2}$$

$$P_{\text{mbar}} = 10^{((2 \times V_{\text{out}} - 11))}$$

$$V_{\text{out}} = \frac{\log_{10}(P_{\text{mbar}}) + 11}{2}$$

$$P_{\text{Pascal}} = 10^{((2 \times V_{\text{out}} - 6))}$$

$$V_{\text{out}} = \frac{\log_{10}(P_{\text{Pascal}}) + 6}{2}$$

The standard MKS analog output always provides 0.5 VDC/decade. If the transducer pressure unit is changed from Torr to Pascal or mbar the analog output scaling will change as well, so it represents 0.5 VDC/decade Torr or 0.5 VDC/decade mbar or Pascal.

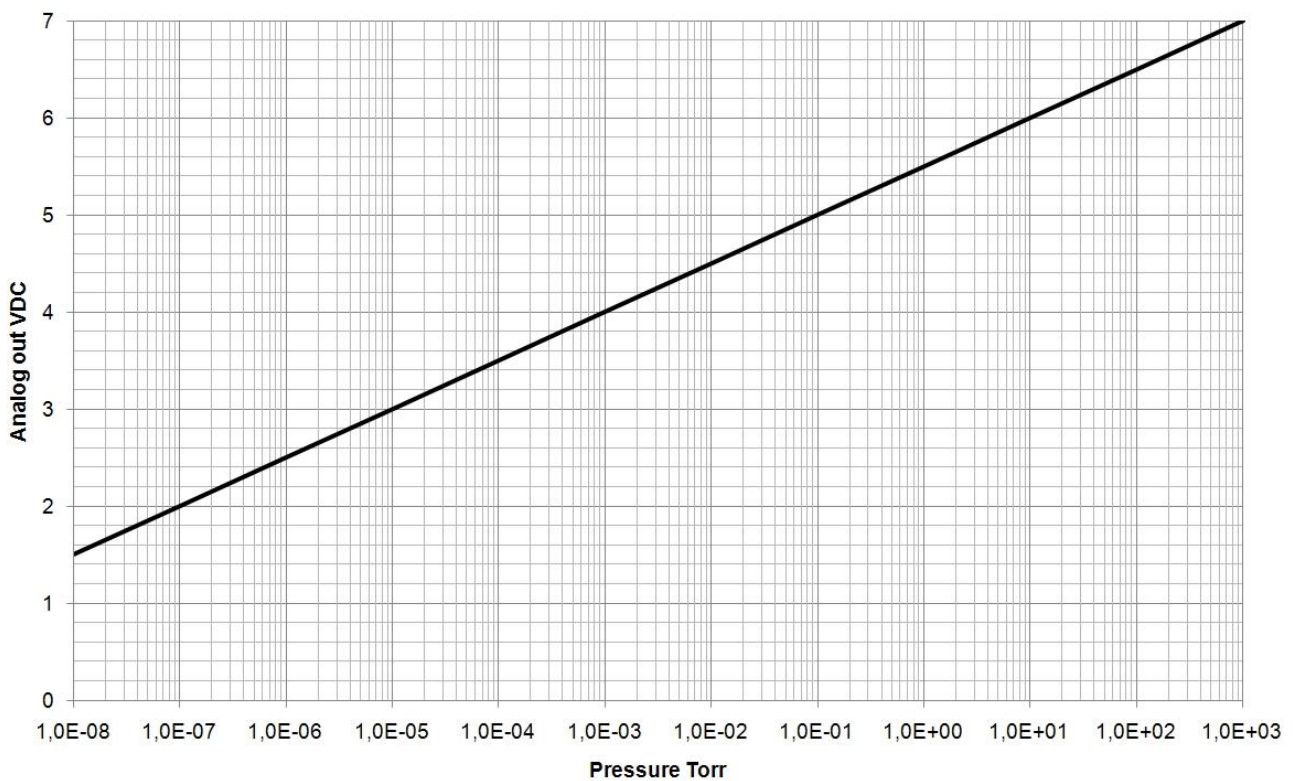

Torr/mbar	Vout	Torr/mbar	Vout	Torr/mbar	Vout	Torr/mbar	Vout
1.0E-8	1.5000	1.0E-5	3.0000	1.0E-2	4.5000	10	6.0000
2.0E-8	1.6505	2.0E-5	3.1505	2.0E-2	4.6505	20	6.1505
4.0E-8	1.8010	4.0E-5	3.3010	4.0E-2	4.8010	40	6.3010
6.0E-8	1.8891	6.0E-5	3.3891	6.0E-2	4.8891	60	6.3891
8.0E-8	1.9515	8.0E-5	3.4515	8.0E-2	4.9515	80	6.4515
1.0E-7	2.0000	1.0E-4	3.5000	1.0E-1	5.0000	100	6.5000
2.0E-7	2.1505	2.0E-4	3.6505	2.0E-1	5.1505	200	6.6505
4.0E-7	2.3010	4.0E-4	3.8010	4.0E-1	5.3010	400	6.8010
6.0E-7	2.3891	6.0E-4	3.8891	6.0E-1	5.3891	600	6.8891
8.0E-7	2.4515	8.0E-4	3.9515	8.0E-1	5.4515	760	6.9404
1.0E-6	2.5000	1.0E-3	4.0000	1.0	5.5000	800	6.9515
2.0E-6	2.6505	2.0E-3	4.1505	2.0	5.6505		
4.0E-6	2.8010	4.0E-3	4.3010	4.0	5.8010		
6.0E-6	2.8891	6.0E-3	4.3891	6.0	5.8891		
8.0E-6	2.9515	8.0E-3	4.4515	8.0	5.9515		

Analog output setup

The 974B can emulate analog voltage outputs from other vacuum transducers. The 974B analog output can be assigned to the MicroPirani sensor measurement (PR1), Cold Cathode sensor measurement (PR2, PR5) and the combined Cold cathode / MicroPirani reading (PR3). This is set by the first digit. The second and third digit represents the analog output calibration. The primary analog output provides 16 bit resolution.



Due to curve form and limits, some of the alternative analog outputs will cause loss of measuring range and accuracy. For best performance use the standard MKS analog output. Change of analog output setup does not interfere on digital reading.

Change of analog output setup:

Command: @253AO1!15;FF
Command values: 10 to 319 (xy)

First digit (x) **1 = PR1 (MicroPirani pressure value assignment)**
 2 = PR2 (Cold Cathode pressure value assignment)
 3 = PR3 (Combined pressure value assignment)

Second digit (y) 0 = MKS Standard (0.5 VDC/decade)
 1 = Edwards APG-L (1.99 -10 VDC)
 2 = Edwards APG100
 3 = Edwards WRG
 4 = Inficon PSG500 /Oerlikon/Leybold TTR91
 5 = Inficon MPG400 / Pfeiffer PKR251
 6 = Inficon BPG400 / MKS 999 Quattro
 7 = Brooks / Granville Phillips GP275
 8 = MKS Moducell 325
 9 = MKS Moducell 325 (x3)
 10 = MKS Baratron 0.1 Torr (0-10 VDC)
 11 = MKS Baratron 1 Torr (0-10 VDC) / Hasting 2002OBE, Channel 2
 12 = MKS Baratron 10 Torr (0-10 VDC)
 13 = MKS Baratron 100 Torr (0-10 VDC)
 14 = MKS Baratron 1000 Torr (0-10 VDC) / Hasting 2002OBE, Channel 1
 15 = Piezo differential output
 16 = Edwards AIM-S /-SL
 17 = Edwards AIM-X / XL
 18 = Pfeiffer IKR251
 19 = Pfeiffer TPR 265
 20 = OBE Channel 2
 21 = Edwards DV6M
 22 = Edwards APG-M
 23 = Brooks / Granville Phillips GP275 (0-9VDC)
 24 = MT 241.1
 25 = Brooks / Granville Phillips GP275 (0-5.6VDC)
 26 = Edwards APG100-LC
 27 = Edwards APG100M
 28 = MKS 907
 29 = K6080-06
 30 = Inficon PEG100
 31 = Varian Eyesys
 32 = Alcatel TA111
 33 = MKS 685

Command reply: @253ACK15;FF
Query: @253AO1?;FF
Query reply: @253ACK15;FF
Factory default: 30

Dual analog output (Optional)

The 974B is available with dual analog output which can be used to provide an alternative output for amplification of range or to emulate another transducer type while still using the MKS standard output. This feature is a hardware option and must be specially ordered. Refer to part number specifications page 3. The secondary analog output provides 12 bit resolution.

Command:	@253AO2!15;FF
Command values:	10 to 319 (xy)
First digit (x)	<i>Use same parameters as primary analog output</i>
Second digit (y)	<i>Use same parameters as primary analog output</i>
Command reply:	@253ACK15;FF
Query:	@253AO2?;FF
Query reply:	@253ACK15;FF
Factory default:	30

Analog output calibration = 1 (Edwards APG-L emulation)

The APG-L emulation provides a strongly non linear output with very poor resolution in the low range and virtually no signal from 100 Torr to atmosphere.

Torr	mbar	Pascal	Vout
1.90E-5	2.53E-5	2.53E-3	1.99
3.00E-5	4.00E-5	4.00E-3	2.00
1.00E-4	1.33E-4	1.33E-2	2.04
5.00E-4	6.66E-4	6.66E-2	2.27
1.00E-3	1.33E-3	1.33E-1	2.50
2.00E-3	2.66E-3	2.66E-1	2.82
5.00E-3	6.66E-3	6.66E-1	3.34
7.00E-3	9.32E-3	9.32E-1	3.53
1.00E-2	1.33E-2	1.33	3.74
2.00E-2	2.66E-2	26.6	4.18
1.00E-1	1.33E-1	13.3	5.42
2.00E-1	2.66E-1	26.6	5.96
5.00E-1	6.66E-1	66.6	6.83
7.00E-1	9.32E-1	93.2	7.19
1.00	1.33	133	7.57
1.20	1.60	160	7.77
2.00	2.66	2.66	8.28
5.00	6.66	666	9.08
10.0	13.3	1.330	9.46
25.0	33.3	3.330	9.72
50.0	66.6	6.660	9.81
75.0	99.9	9.990	9.84
200	266	26.600	9.96
500	666	66.600	9.98
760	1013	101.300	10.00

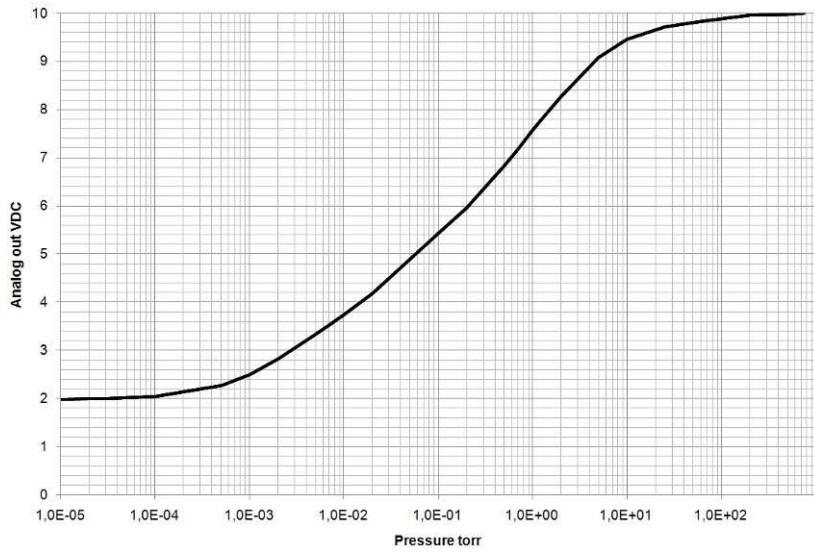

Analog output calibration = 2 (Edwards APG-100 emulation)

The APG-L emulation provides a log linear output of 1 VDC/mbar.

$$P_{Torr} = 10^{(V_{out} - 6.125)}$$

$$P_{mbar} = 10^{(V_{out} - 6)}$$

$$P_{Pascal} = 10^{(V_{out} - 4)}$$

$$V_{out} = \log_{10}(P_{Torr}) + 6.125$$

$$V_{out} = \log_{10}(P_{mbar}) + 6$$

$$V_{out} = \log_{10}(P_{Pascal}) + 4$$

Torr	mbar	Pascal	Vout
7.50E-5	1.00E-4	1.00E-2	2.00
7.50E-4	1.00E-3	1.00E-1	3.00
7.50E-3	1.00E-2	1.00	4.00
7.50E-2	1.00E-1	10.0	5.00
7.50E-1	1.00	100	6.00
7.50	10.0	1.000	7.00
75.0	100	10.000	8.00
750	1.000	100.000	9.00

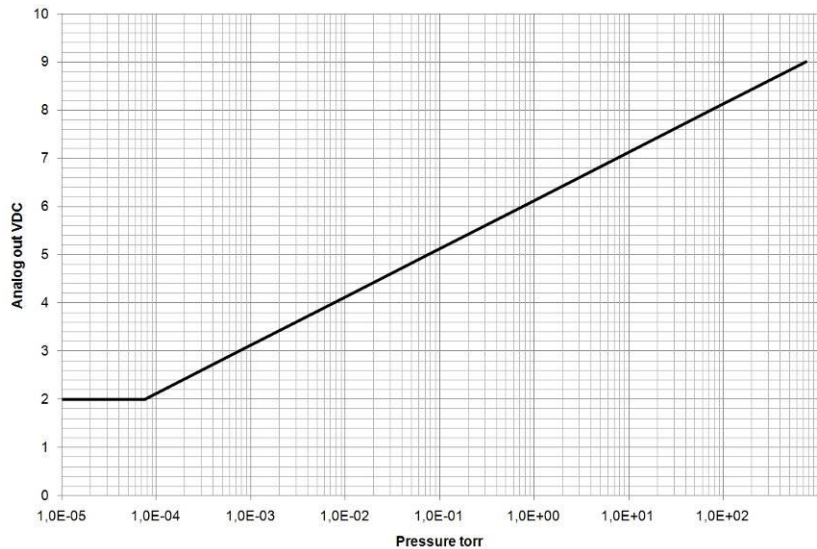

Analog output calibration = 3 (Edward WRG emulation)

The WRG emulation covers a wider measuring range than supported by the 974B range.

$$P_{\text{Torr}} = 10^{(1.5 \times V_{\text{out}} - 12.125)}$$

$$P_{\text{mbar}} = 10^{(1.5 \times V_{\text{out}} - 12)}$$

$$P_{\text{Pascal}} = 10^{(1.5 \times V_{\text{out}} - 10)}$$

$$V_{\text{out}} = (\log_{10}(P_{\text{Torr}}) + 12.125) / 1.5$$

$$V_{\text{out}} = (\log_{10}(P_{\text{mbar}}) + 12) / 1.5$$

$$V_{\text{out}} = (\log_{10}(P_{\text{Pascal}}) + 10) / 1.5$$

Torr	mbar	Pascal	Vout
1.00E-8	1.33E-8	1.33E-6	2.75
2.37E-8	3.16E-8	3.16E-6	3.00
7.50E-7	1.00E-6	1.00E-4	4.00
2.37E-5	3.16E-5	3.16E-2	5.00
7.50E-4	1.00E-3	1.00E-1	6.00
2.37E-2	3.16E-2	3.16	7.00
7.50E-1	1.00	100	8.00
2.37	31.6	3.160	9.00
750.0	1.000	100.000	10.00

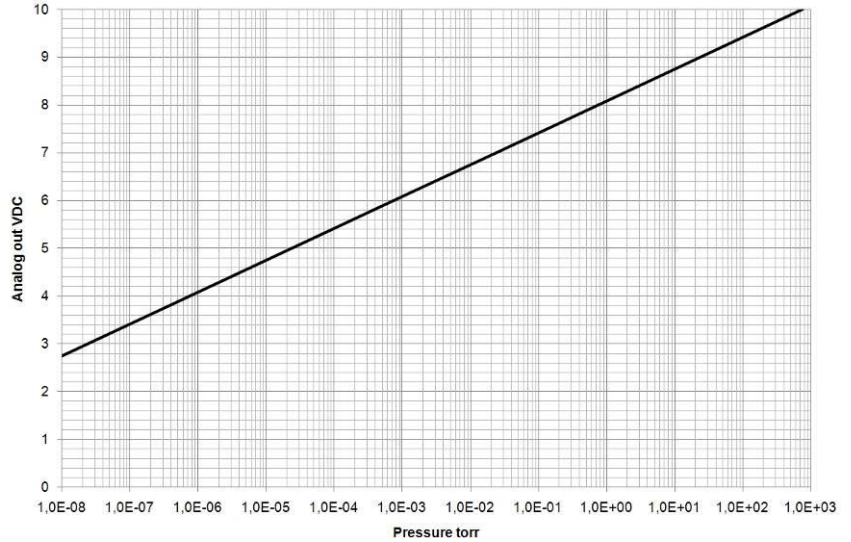

Analog output calibration = 4 (Inficon PSG500 / Oerlikon TTR91 emulation)

The TTR91 emulation provides a log linear output. The output does not provide a pressure dependent signal at pressures below 2.00E-4 Torr.

$$P_{\text{Torr}} = 10^{((V_{\text{out}} - 6.304) / 1.286)}$$

$$P_{\text{mbar}} = 10^{((V_{\text{out}} - 6.143) / 1.286)}$$

$$P_{\text{Pascal}} = 10^{((V_{\text{out}} - 3.572) / 1.286)}$$

$$V_{\text{out}} = \log_{10}(P_{\text{Torr}}) \times 1.286 + 6.304$$

$$V_{\text{out}} = \log_{10}(P_{\text{mbar}}) \times 1.286 + 6.143$$

$$V_{\text{out}} = \log_{10}(P_{\text{Pascal}}) \times 1.286 + 3.572$$

Torr	mbar	Pascal	Vout
1.00E-5	1.33E-05	1.33E-03	1.547
2.00E-04	2.67E-04	2.67E-02	1.547
5.00E-04	6.67E-04	6.67E-02	2.058
1.00E-03	1.33E-03	1.33E-01	2.446
1.00E-02	1.33E-02	1.33E+00	3.732
1.00E-01	1.33E-01	1.33E+01	5.018
1.00E+00	1.33E+00	1.33E+02	6.304
1.00E+01	1.33E+01	1.33E+03	7.59
1.00E+02	1.33E+02	1.33E+04	8.876
7.60E+02	1.01E+03	1.01E+05	10.00873

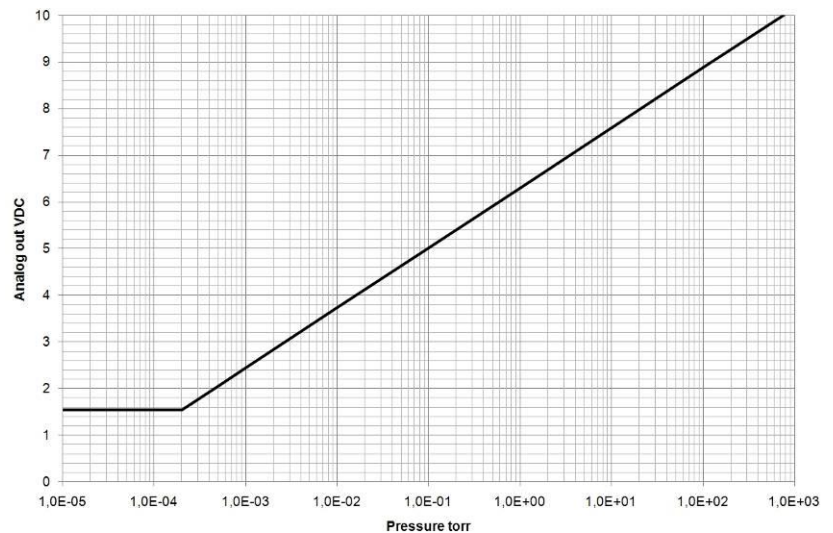

Analog output calibration = 5 (Inficon MPG400 / Inficon PKR251 / Pfeiffer PKR251 emulation)

$$P_{\text{Torr}} = 10^{((V_{\text{out}} - 6.875)/0.6)}$$

$$P_{\text{mbar}} = 10^{((V_{\text{out}} - 6.8)/0.6)}$$

$$P_{\text{Pascal}} = 10^{((V_{\text{out}} - 5.6)/0.6)}$$

$$V_{\text{out}} = \log_{10}(P_{\text{Torr}}) \times 0.6 + 6.875$$

$$V_{\text{out}} = \log_{10}(P_{\text{mbar}}) \times 0.6 + 6.8$$

$$V_{\text{out}} = \log_{10}(P_{\text{Pascal}}) \times 0.6 + 5.6$$

Torr	mbar	Pascal	Vout
1.00E-08	1.33E-08	1.33E-06	2.075
1.00E-07	1.33E-07	1.33E-05	2.675
1.00E-06	1.33E-06	1.33E-04	3.275
1.00E-05	1.33E-05	1.33E-03	3.875
1.00E-04	1.33E-04	1.33E-02	4.475
1.00E-03	1.33E-03	1.33E-01	5.075
1.00E-02	1.33E-02	1.33E+00	5.675
1.00E-01	1.33E-01	1.33E+01	6.275
1.00E+00	1.33E+00	1.33E+02	6.875
1.00E+01	1.33E+01	1.33E+03	7.475
1.00E+02	1.33E+02	1.33E+04	8.075
7.60E+02	1.01E+03	1.01E+05	8.603

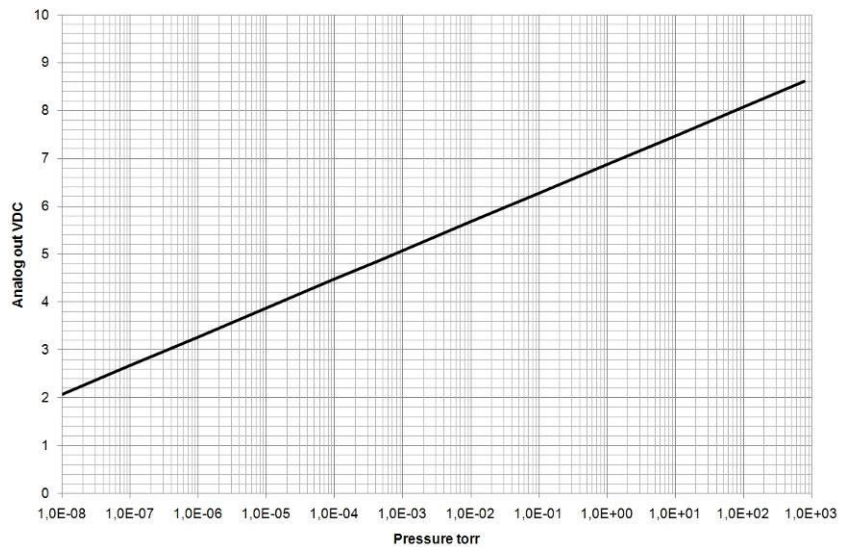

Analog output calibration = 6 (Inficon BPG400 emulation)

$$P_{\text{Torr}} = 10^{((V_{\text{out}} - 7.75)/0.75)} - 0.125$$

$$P_{\text{mbar}} = 10^{(V_{\text{out}}/0.75)}$$

$$P_{\text{Pascal}} = 10^{(V_{\text{out}}/0.75)} + 2$$

$$V_{\text{out}} = \log_{10}(P_{\text{Torr}} + 0.125) \times 0.75 + 7.75$$

$$V_{\text{out}} = \log_{10}(P_{\text{mbar}}) \times 0.75$$

$$V_{\text{out}} = \log_{10}(P_{\text{Pascal}} - 2) \times 0.75$$

Torr	mbar	Pascal	Vout
1.00E-08	1.33E-08	1.33E-06	1.843
1.00E-07	1.33E-07	1.33E-05	2.593
1.00E-06	1.33E-06	1.33E-04	3.343
1.00E-05	1.33E-05	1.33E-03	4.093
1.00E-04	1.33E-04	1.33E-02	4.843
5.00E-04	6.67E-04	6.67E-02	5.367
1.00E-03	1.33E-03	1.33E-01	5.593
1.00E-02	1.33E-02	1.33E+00	6.343
1.00E-01	1.33E-01	1.33E+01	7.093
1.00E+00	1.33E+00	1.33E+02	7.843
1.00E+01	1.33E+01	1.33E+03	8.593
1.00E+02	1.33E+02	1.33E+04	9.343
7.60E+02	1.01E+03	1.01E+05	10.004

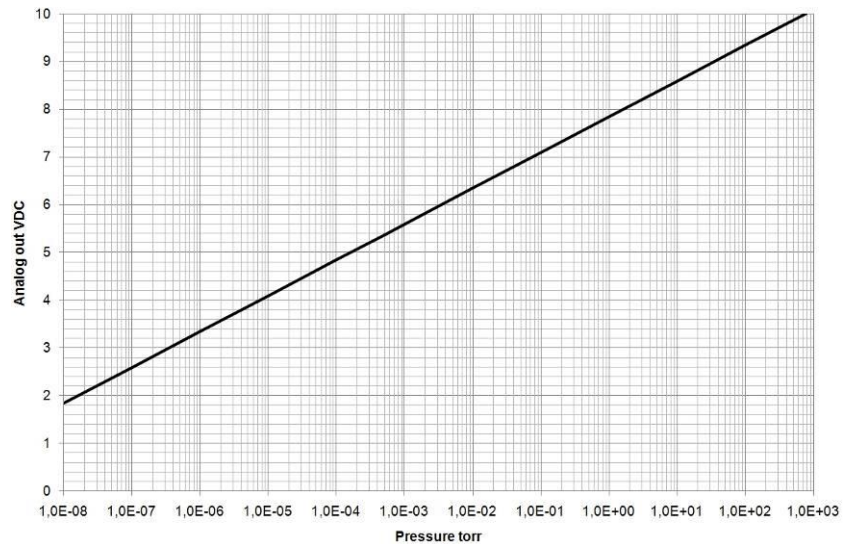

Analog output calibration = 7 (Brooks / Granville Phillips GP275 emulation)

The GP275 emulation provides a strongly non linear output with very poor resolution in the low range and close to atmospheric pressure.

Torr	mbar	Pascal	Vout
1.00E-05	1.33E-05	1.33E-03	0.372
1.00E-04	1.33E-04	1.33E-02	0.372
2.50E-04	3.33E-04	3.33E-02	0.376
5.00E-04	6.67E-04	6.67E-02	0.381
7.50E-04	1.00E-03	1.00E-01	0.385
1.00E-03	1.33E-03	1.33E-01	0.388
2.50E-03	3.33E-03	3.33E-01	0.406
5.00E-03	6.67E-03	6.67E-01	0.431
7.50E-03	1.00E-02	1.00E+00	0.452
1.00E-02	1.33E-02	1.33E+00	0.470
2.50E-02	3.33E-02	3.33E+00	0.563
5.00E-02	6.67E-02	6.67E+00	0.682
7.50E-02	1.00E-01	1.00E+01	0.780
1.00E-01	1.33E-01	1.33E+01	0.867
2.50E-01	3.33E-01	3.33E+01	1.255
5.00E-01	6.67E-01	6.67E+01	1.684
7.50E-01	1.00E+00	1.00E+02	1.990
1.00E+00	1.33E+00	1.33E+02	2.228
2.50E+00	3.33E+00	3.33E+02	3.053
5.00E+00	6.67E+00	6.67E+02	3.664
7.50E+00	1.00E+01	1.00E+03	3.986
1.00E+01	1.33E+01	1.33E+03	4.191
2.50E+01	3.33E+01	3.33E+03	4.706
5.00E+01	6.67E+01	6.67E+03	4.846
7.50E+01	1.00E+02	1.00E+04	4.896
1.00E+02	1.33E+02	1.33E+04	4.928
2.50E+02	3.33E+02	3.33E+04	5.073
5.00E+02	6.67E+02	6.67E+04	5.300
6.00E+02	8.00E+02	8.00E+04	5.390
7.00E+02	9.33E+02	9.33E+04	5.480
7.60E+02	1.01E+03	1.01E+05	5.534
8.00E+02	1.07E+03	1.07E+05	5.570

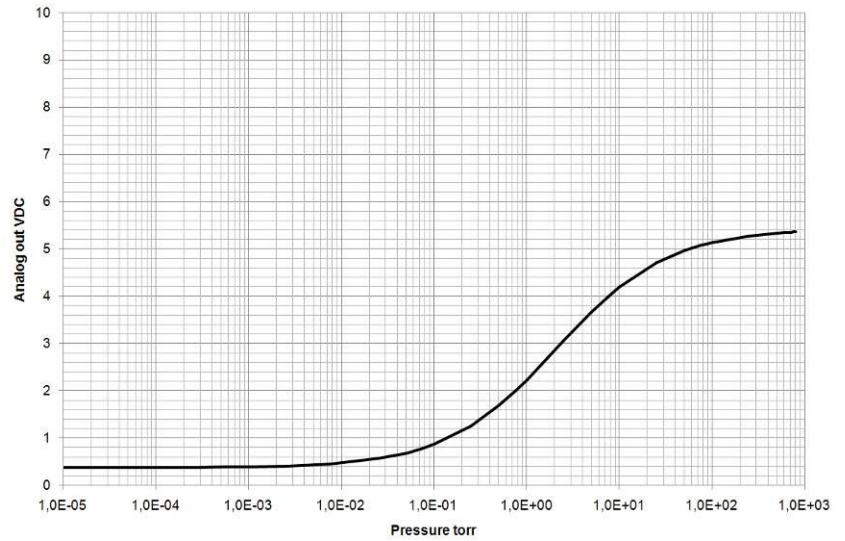

Analog out calibration = 8 (MKS Moducell 325)

The Moducell emulation provides a strongly non linear output.

Torr	mbar	Pascal	Vout
1.00E-05	1.33E-05	1.33E-03	0.2509
1.00E-04	1.33E-04	1.33E-02	0.2524
2.50E-04	3.33E-04	3.33E-02	0.2550
5.00E-04	6.67E-04	6.67E-02	0.2592
7.50E-04	1.00E-03	1.00E-01	0.2633
1.00E-03	1.33E-03	1.33E-01	0.2674
2.50E-03	3.33E-03	3.33E-01	0.2905
5.00E-03	6.67E-03	6.67E-01	0.3251
7.50E-03	1.00E-02	1.00E+00	0.3561
1.00E-02	1.33E-02	1.33E+00	0.3845
2.50E-02	3.33E-02	3.33E+00	0.5215
5.00E-02	6.67E-02	6.67E+00	0.6868
7.50E-02	1.00E-01	1.00E+01	0.8144
1.00E-01	1.33E-01	1.33E+01	0.9205
2.50E-01	3.33E-01	3.33E+01	1.3489
5.00E-01	6.67E-01	6.67E+01	1.7504
7.50E-01	1.00E+00	1.00E+02	1.9986
1.00E+00	1.33E+00	1.33E+02	2.1720
2.50E+00	3.33E+00	3.33E+02	2.6512
5.00E+00	6.67E+00	6.67E+02	2.9012
7.50E+00	1.00E+01	1.00E+03	3.0022
1.00E+01	1.33E+01	1.33E+03	3.0569
2.50E+01	3.33E+01	3.33E+03	3.1639
5.00E+01	6.67E+01	6.67E+03	3.2023
7.50E+01	1.00E+02	1.00E+04	3.2154
1.00E+02	1.33E+02	1.33E+04	3.2221
2.50E+02	3.33E+02	3.33E+04	3.2342
5.00E+02	6.67E+02	6.67E+04	3.2382
6.00E+02	8.00E+02	8.00E+04	3.2389
7.00E+02	9.33E+02	9.33E+04	3.2394
7.60E+02	1.01E+03	1.01E+05	3.2396
8.00E+02	1.07E+03	1.07E+05	3.2398

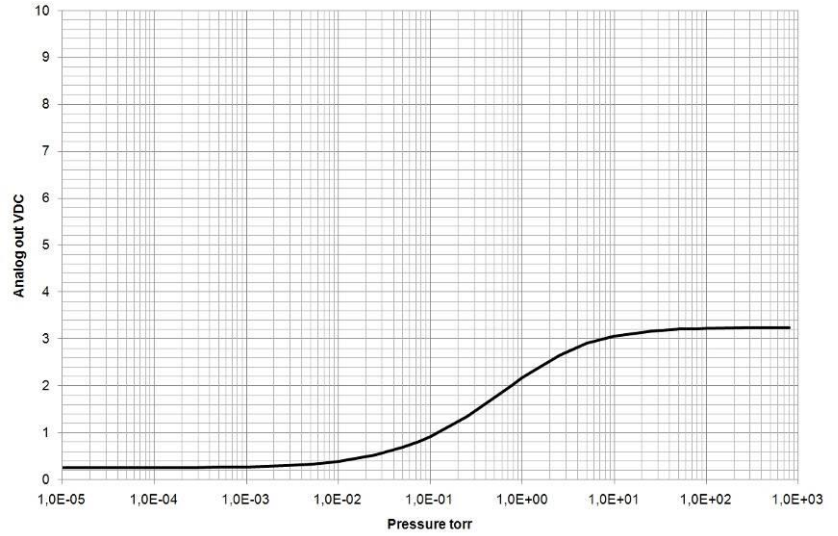

Analog out calibration = 9 (MKS Moducell 325, amplified 3 times)

The Moducell x3 emulation is in curve form identical with the standard Moducell, however, to provide better signal resolution the signal is amplified by a factor three.

Torr	mbar	Pascal	Vout
1.00E-05	1.33E-05	1.33E-03	0.753
1.00E-04	1.33E-04	1.33E-02	0.757
2.50E-04	3.33E-04	3.33E-02	0.765
5.00E-04	6.67E-04	6.67E-02	0.778
7.50E-04	1.00E-03	1.00E-01	0.790
1.00E-03	1.33E-03	1.33E-01	0.802
2.50E-03	3.33E-03	3.33E-01	0.871
5.00E-03	6.67E-03	6.67E-01	0.975
7.50E-03	1.00E-02	1.00E+00	1.068
1.00E-02	1.33E-02	1.33E+00	1.154
2.50E-02	3.33E-02	3.33E+00	1.565
5.00E-02	6.67E-02	6.67E+00	2.060
7.50E-02	1.00E-01	1.00E+01	2.443
1.00E-01	1.33E-01	1.33E+01	2.762
2.50E-01	3.33E-01	3.33E+01	4.047
5.00E-01	6.67E-01	6.67E+01	5.251
7.50E-01	1.00E+00	1.00E+02	5.996
1.00E+00	1.33E+00	1.33E+02	6.516
2.50E+00	3.33E+00	3.33E+02	7.954
5.00E+00	6.67E+00	6.67E+02	8.704
7.50E+00	1.00E+01	1.00E+03	9.007
1.00E+01	1.33E+01	1.33E+03	9.171
2.50E+01	3.33E+01	3.33E+03	9.492
5.00E+01	6.67E+01	6.67E+03	9.607
7.50E+01	1.00E+02	1.00E+04	9.646
1.00E+02	1.33E+02	1.33E+04	9.666
2.50E+02	3.33E+02	3.33E+04	9.702
5.00E+02	6.67E+02	6.67E+04	9.715
6.00E+02	8.00E+02	8.00E+04	9.717
7.00E+02	9.33E+02	9.33E+04	9.718
7.60E+02	1.01E+03	1.01E+05	9.719
8.00E+02	1.07E+03	1.07E+05	9.719

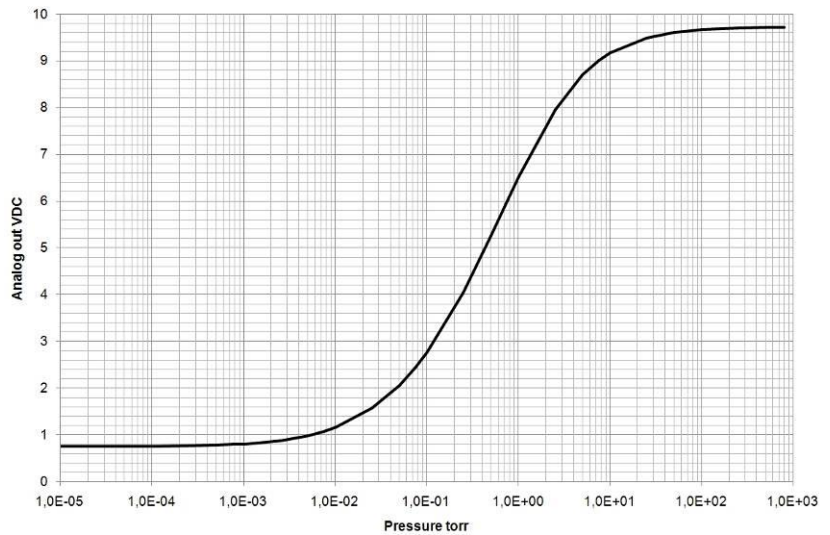

Analog out calibration = 10 (MKS Baratron 0.1 Torr)

The 0.1 Torr Baratron emulation provides a signal directly proportional with pressure with a full scale reading of 10 VDC at 0.1 Torr.

Torr	mbar	Pascal	Vout
1.00E-3	1.33E-3	1.33E-1	0.100
5.00E-3	6.66E-3	6.66E-1	0.500
1.00E-2	1.33E-2	1.33E0	1.000
5.00E-2	6.66E-2	6.66E0	5.000
1.00E-1	1.33E-1	1.33E+1	10.000



Analog out calibration = 11 (MKS Baratron 1 Torr)

The 1 Torr Baratron emulation provides a signal directly proportional with pressure with a full scale reading of 10 VDC at 1 Torr.

Torr	mbar	Pascal	Vout
1.00E-2	1.33E-2	1.33E0	0.100
5.00E-2	6.66E-2	6.66E0	0.500
1.00E-1	1.33E-1	1.33E+1	1.000
5.00E-1	6.66E-1	6.66E+1	5.000
1.00E0	1.33E0	1.33E+2	10.000

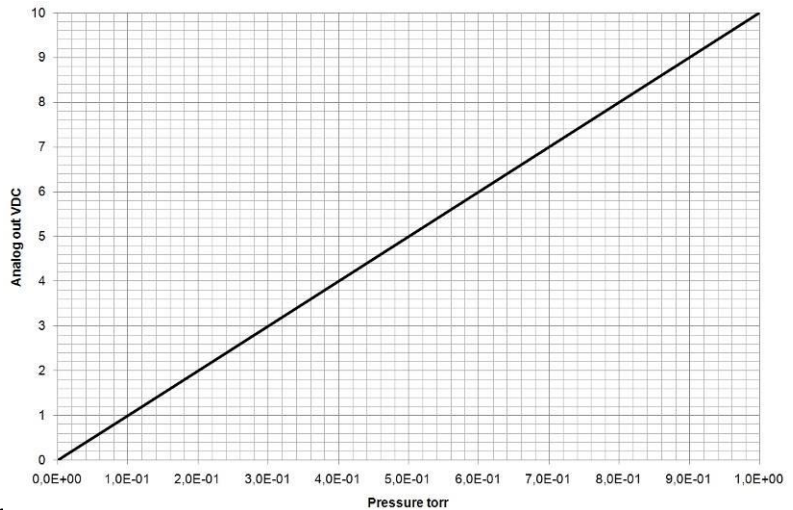

Analog out calibration = 12 (MKS Baratron 10 Torr)

The 10 Torr Baratron emulation provides a signal directly proportional with pressure with a full scale reading of 10 VDC at 10 Torr.

Torr	mbar	Pascal	Vout
1.00E-1	1.33E-1	1.33E+1	0.100
5.00E-1	6.66E-1	6.66E+1	0.500
1.00E0	1.33E0	1.33E+2	1.000
5.00E0	6.66E0	6.66E+2	5.000
1.00E+1	1.33E+1	1.33E+3	10.000

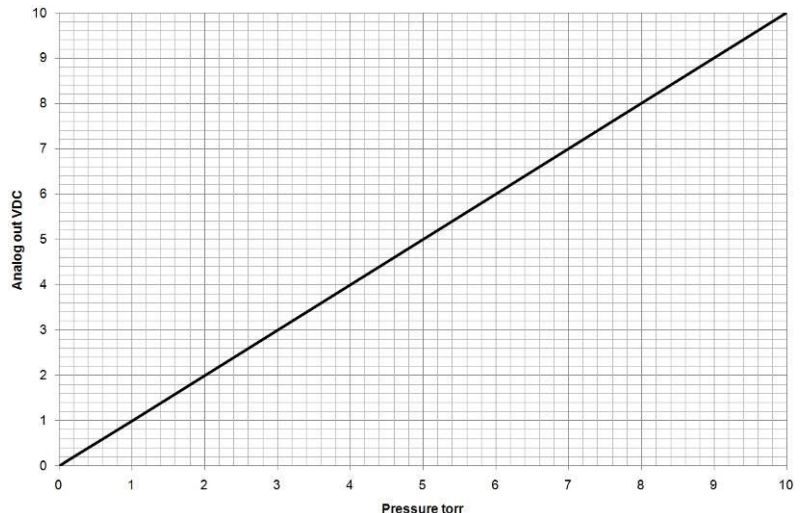

Analog out calibration = 13 (MKS Baratron 100 Torr)

The 100 Torr Baratron emulation provides a signal directly proportional with pressure with a full scale reading of 10 VDC at 100 Torr.

Torr	mbar	Pascal	Vout
1.0	1.33	1.333E+2	0.100
5.0	6.66	6.66E+2	0.500
10.0	13.3	1.333E+3	1.000
50.0	66.66	6.66E+3	5.000
100.0	133.3	1.333E+4	10.000

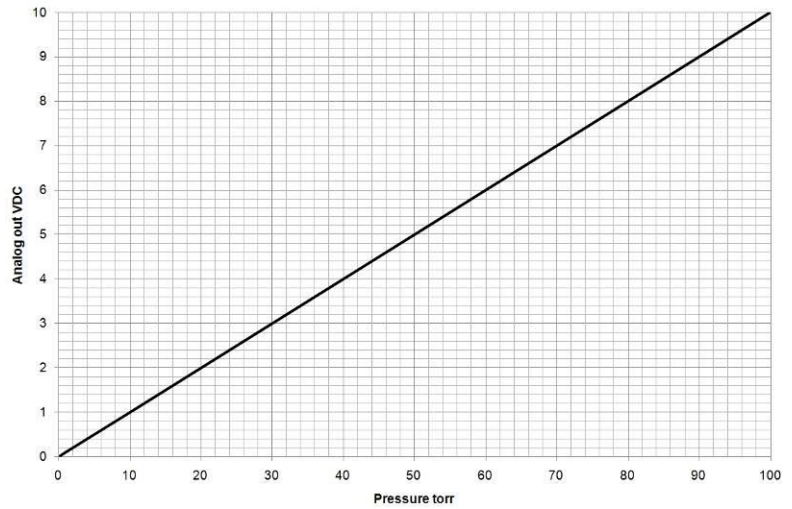

Analog out calibration = 14 (MKS Baratron 1000 Torr)

The 1000 Torr Baratron emulation provides a signal directly proportional with pressure with a full scale reading of 10 VDC at 1000 Torr.

Torr	mbar	Pascal	Vout
10.0	13.3	1.333E+3	0.100
50.0	66.66	6.66E+3	0.500
100.0	133.3	1.333E+4	1.000
500.0	666.6	6.666E+4	5.000
1,000	1333.2	1.3332E+5	10.000

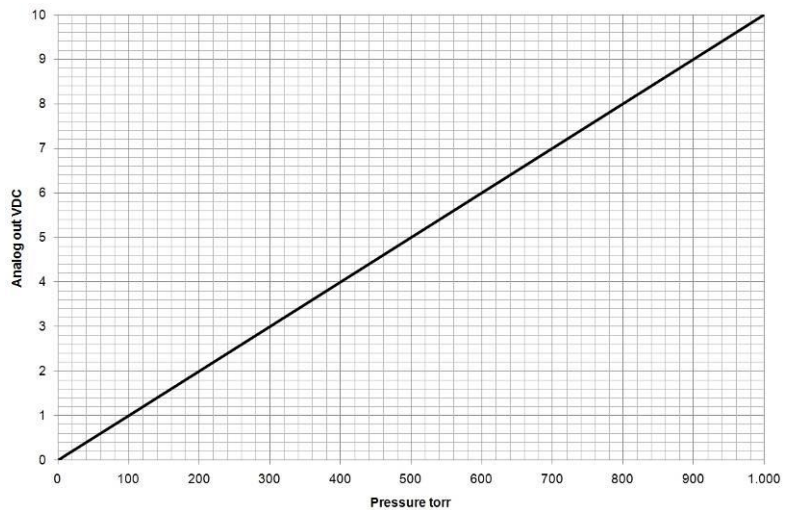

Analog out calibration = 15 (Piezo analog output)

Torr	mbar	Pascal	Vout
-8.00E+2	-1.07E+3	-1.07E+5	1.10
-7.00E+2	-9.33E+2	-9.33E+4	1.15
-6.00E+2	-8.00E+2	-8.00E+4	1.22
-5.00E+2	-6.67E+2	-6.67E+4	1.30
-4.00E+2	-5.33E+2	-5.33E+4	1.40
-3.00E+2	-4.00E+2	-4.00E+4	1.52
-2.00E+2	-2.67E+2	-2.67E+4	1.70
-1.00E+2	-1.33E+2	-1.33E+4	2.00
-9.00E+1	-1.20E+2	-1.20E+4	2.05
-8.00E+1	-1.07E+2	-1.07E+4	2.10
-7.00E+1	-9.33E+1	-9.33E+3	2.15
-6.00E+1	-8.00E+1	-8.00E+3	2.22
-5.00E+1	-6.67E+1	-6.67E+3	2.30
-4.00E+1	-5.33E+1	-5.33E+3	2.40
-3.00E+1	-4.00E+1	-4.00E+3	2.52
-2.00E+1	-2.67E+1	-2.67E+3	2.70
-1.00E+1	-1.33E+1	-1.33E+3	3.00
-9.00E+0	-1.20E+1	-1.20E+3	3.05
-8.00E+0	-1.07E+1	-1.07E+3	3.10
-7.00E+0	-9.33E+0	-9.33E+2	3.15
-6.00E+0	-8.00E+0	-8.00E+2	3.22
-5.00E+0	-6.67E+0	-6.67E+2	3.30
-4.00E+0	-5.33E+0	-5.33E+2	3.40
-3.00E+0	-4.00E+0	-4.00E+2	3.52
-2.00E+0	-2.67E+0	-2.67E+2	3.70
-1.00E+0	-1.33E+0	-1.33E+2	4.00
-9.00E-1	-1.20E+0	-1.20E+2	4.05
-8.00E-1	-1.07E+0	-1.07E+2	4.10
-7.00E-1	-9.33E-1	-9.33E+1	4.15
-6.00E-1	-8.00E-1	-8.00E+1	4.22
-5.00E-1	-6.67E-1	-6.67E+1	4.30
-4.00E-1	-5.33E-1	-5.33E+1	4.40
-3.00E-1	-4.00E-1	-4.00E+1	4.52
-2.00E-1	-2.67E-1	-2.67E+1	4.70
-1.00E-1	-1.33E-1	-1.33E+1	5.00
1.00E-1	1.33E-1	1.33E+1	5.00
2.00E-1	2.67E-1	2.67E+1	5.30
3.00E-1	4.00E-1	4.00E+1	5.48
4.00E-1	5.33E-1	5.33E+1	5.60
5.00E-1	6.67E-1	6.67E+1	5.70
6.00E-1	8.00E-1	8.00E+1	5.78
7.00E-1	9.33E-1	9.33E+1	5.85
8.00E-1	1.07E+0	1.07E+2	5.90
9.00E-1	1.20E+0	1.20E+2	5.95
1.00E+0	1.33E+0	1.33E+2	6.00
2.00E+0	2.67E+0	2.67E+2	6.30
3.00E+0	4.00E+0	4.00E+2	6.48
4.00E+0	5.33E+0	5.33E+2	6.60
5.00E+0	6.67E+0	6.67E+2	6.70
6.00E+0	8.00E+0	8.00E+2	6.78
7.00E+0	9.33E+0	9.33E+2	6.85
8.00E+0	1.07E+1	1.07E+3	6.90
9.00E+0	1.20E+1	1.20E+3	6.95
1.00E+1	1.33E+1	1.33E+3	7.00
2.00E+1	2.67E+1	2.67E+3	7.30
3.00E+1	4.00E+1	4.00E+3	7.48
4.00E+1	5.33E+1	5.33E+3	7.60
5.00E+1	6.67E+1	6.67E+3	7.70
6.00E+1	8.00E+1	8.00E+3	7.78
7.00E+1	9.33E+1	9.33E+3	7.85
8.00E+1	1.07E+2	1.07E+4	7.90
9.00E+1	1.20E+2	1.20E+4	7.95
1.00E+2	1.33E+2	1.33E+4	8.00
2.00E+2	2.67E+2	2.67E+4	8.30
3.00E+2	4.00E+2	4.00E+4	8.48
4.00E+2	5.33E+2	5.33E+4	8.60
5.00E+2	6.67E+2	6.67E+4	8.70
6.00E+2	8.00E+2	8.00E+4	8.78
7.00E+2	9.33E+2	9.33E+4	8.85
8.00E+2	1.07E+3	1.07E+5	8.90
9.00E+2	1.20E+3	1.20E+5	8.95
1.00E+3	1.33E+3	1.33E+5	9.00

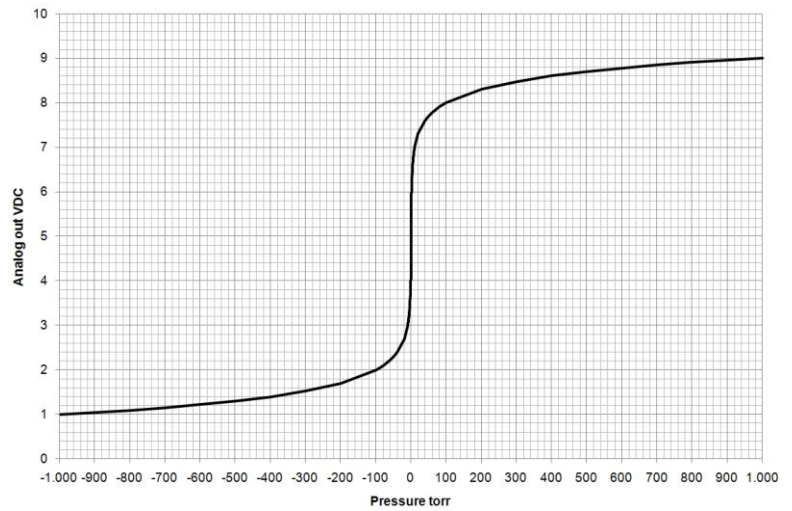

For positive pressure ($V_{out} > 5VDC$)

$$\text{Piezo pressure} = 10^{(PZV_{out}-6)}$$

For negative pressure ($V_{out} \leq 5 VDC$):

$$\text{Piezo pressure} = \frac{-1}{10^{(PZV_{out}-4)}}$$

Analog out calibration = 16 (Edwards AIM-S /SL)

The Edwards AIM-S / SL emulation provides a strongly non linear output.

Torr	mbar	Pascal	Vout
1.00E-8	1.33E-8	1.33E-6	2.5
1.80E-8	2.40E-8	2.40E-6	2.5
4.40E-8	5.87E-8	5.87E-6	3
6.10E-8	8.13E-8	8.13E-6	3.2
8.30E-8	1.11E-7	1.11E-5	3.4
1.10E-7	1.47E-7	1.47E-5	3.6
2.20E-7	2.93E-7	2.93E-5	4
5.50E-7	7.33E-7	7.33E-5	4.6
7.40E-7	9.87E-7	9.87E-5	4.8
9.80E-7	1.31E-6	1.31E-4	5
1.30E-6	1.73E-6	1.73E-4	5.2
2.10E-6	2.80E-6	2.80E-4	5.6
3.40E-6	4.53E-6	4.53E-4	6
4.20E-6	5.60E-6	5.60E-4	6.2
5.20E-6	6.93E-6	6.93E-4	6.4
7.50E-6	1.00E-5	1.00E-3	6.8
9.00E-6	1.20E-5	1.20E-3	7
1.10E-5	1.47E-5	1.47E-3	7.2
2.20E-5	2.93E-5	2.93E-3	8
3.20E-5	4.27E-5	4.27E-3	8.4
4.30E-5	5.73E-5	5.73E-3	8.6
5.90E-5	7.87E-5	7.87E-3	8.8
9.00E-5	1.20E-4	1.20E-2	9
1.40E-4	1.87E-4	1.87E-2	9.2
2.5E-4	3.33E-4	3.33E-2	9.4
5.0E-4	6.67E-4	6.67E-2	9.6
1.3E-3	1.73E-3	1.73E-1	9.8
2.7E-3	3.60E-3	3.60E-1	9.9
7.5E-3	1.00E-2	1.00E+0	10

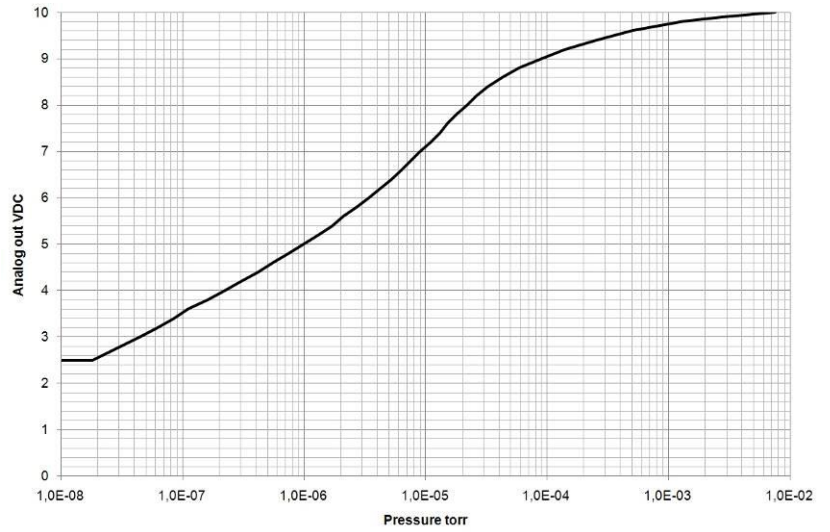

Analog out calibration = 17 (Edwards AIM-X /XL)

The Edwards AIM-X / XL emulation provides a log linear output.

Torr	mbar	Pascal	Vout
1.00E-8	1.33E-8	1.33E-6	3.286
5.00E-8	6.67E-8	6.67E-6	4.084
1.00E-7	1.33E-7	1.33E-5	4.428
5.00E-7	6.67E-7	6.67E-5	5.227
1.00E-6	1.33E-6	1.33E-4	5.571
5.00E-6	6.67E-6	6.67E-4	6.370
1.00E-5	1.33E-5	1.33E-3	6.714
5.00E-5	6.67E-5	6.67E-3	7.513
1.00E-4	1.33E-4	1.33E-2	7.857
5.00E-4	6.67E-4	6.67E-2	8.656
1.00E-3	1.33E-3	1.33E-1	9.000
5.00E-3	6.67E-3	6.67E-1	9.799

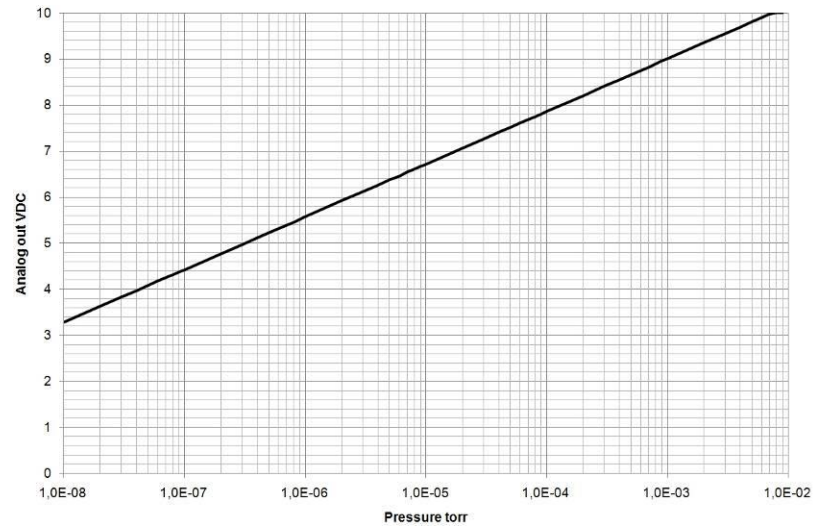

Analog out calibration = 18 (Pfeiffer IKR251)

The Pfeiffer IKR251 emulation provides a log linear output.

Torr	mbar	Pascal	Vout
5.00E-9	6.67E-9	6.67E-7	2.3240
1.00E-8	1.33E-8	1.33E-6	2.6250
5.00E-8	6.67E-8	6.67E-6	3.3240
1.00E-7	1.33E-7	1.33E-5	3.6250
5.00E-7	6.67E-7	6.67E-5	4.3240
1.00E-6	1.33E-6	1.33E-4	4.6250
5.00E-6	6.67E-6	6.67E-4	5.3240
1.00E-5	1.33E-5	1.33E-3	5.6250
5.00E-5	6.67E-5	6.67E-3	6.3240
1.00E-4	1.33E-4	1.33E-2	6.6250
5.00E-4	6.67E-4	6.67E-2	7.3240
1.00E-3	1.33E-3	1.33E-1	7.6250
5.00E-3	6.67E-3	6.67E-1	8.3240
9.00E-3	1.20E-2	1.20E+0	8.5000

$$P = 10^{(V_{out} - c)}$$

$$V_{out} = c + \log_{10}(P)$$

	c
mbar	10.5
Torr	10.625
Pascal	8.5

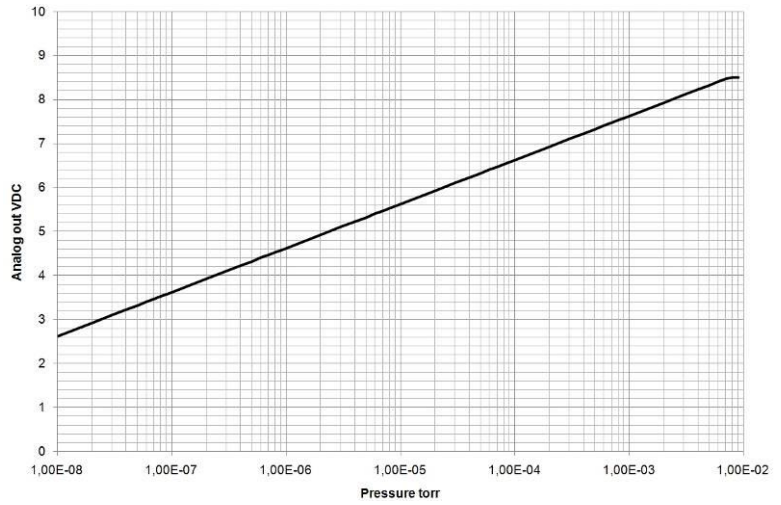

Analog out calibration = 19 (Pfeiffer TPR265, Pfeiffer TPR280, Inficon TPR280)

The Pfeiffer TPR265 emulation provides a log linear output.

Torr	mbar	Pascal	Vout
1.00E-4	1.33E-4	1.33E-2	2.199
4.00E-4	5.33E-4	5.33E-2	2.227
5.00E-4	6.67E-4	6.67E-2	2.324
1.00E-3	1.33E-3	1.33E-1	2.625
5.00E-3	6.67E-3	6.67E-1	3.324
1.00E-2	1.33E-2	1.33E+0	3.625
5.00E-2	6.67E-2	6.67E+0	4.324
1.00E-1	1.33E-1	1.33E+1	4.625
5.00E-1	6.67E-1	6.67E+1	5.324
1.00E+0	1.33E+0	1.33E+2	5.625
5.00E+0	6.67E+0	6.67E+2	6.324
1.00E+1	1.33E+1	1.33E+3	6.625
5.00E+1	6.67E+1	6.67E+3	7.324
1.00E+2	1.33E+2	1.33E+4	7.625
5.00E+2	6.67E+2	6.67E+4	8.324
9.00E+2	1.20E+3	1.20E+5	8.579
1.00E+3	1.33E+3	1.33E+5	8.625

$$P = 10^{(V_{out} - c)}$$

$$V_{out} = c + \log_{10}(P)$$

	c
mbar	5.5
Torr	5.625
Pascal	3.5

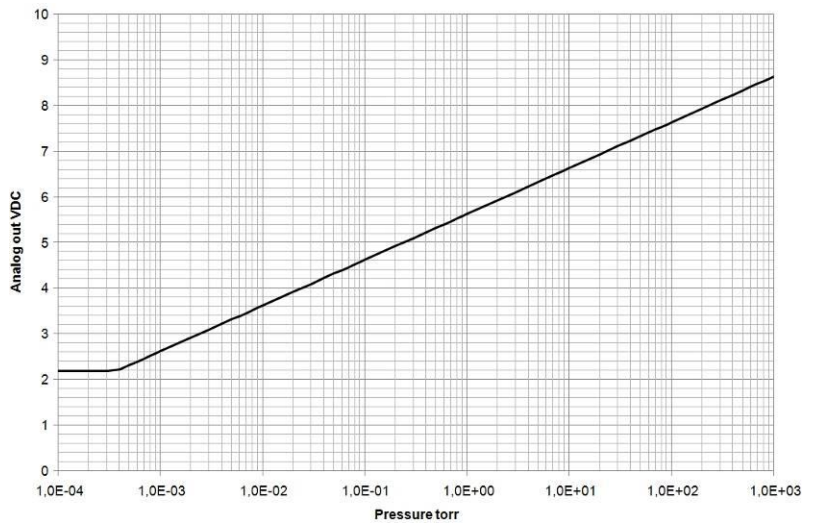

Analog out calibration = 20 (OBE Special)

The OBE special emulation provides a linear output from 1 to 1000 Torr.

Torr	mbar	Pascal	Vout
0.1	1.33E-01	1.33E+01	5
1	1.33E+00	1.33E+02	5
2	2.67E+00	2.67E+02	5.005
4	5.33E+00	5.33E+02	5.015
5	6.67E+00	6.67E+02	5.02
10	1.33E+01	1.33E+03	5.045
25	3.33E+01	3.33E+03	5.12
50	6.67E+01	6.67E+03	5.245
75	1.00E+02	1.00E+04	5.37
100	1.33E+02	1.33E+04	5.495
250	3.33E+02	3.33E+04	6.245
500	6.67E+02	6.67E+04	7.495
750	1.00E+03	1.00E+05	8.745
1000	1.33E+03	1.33E+05	9.995

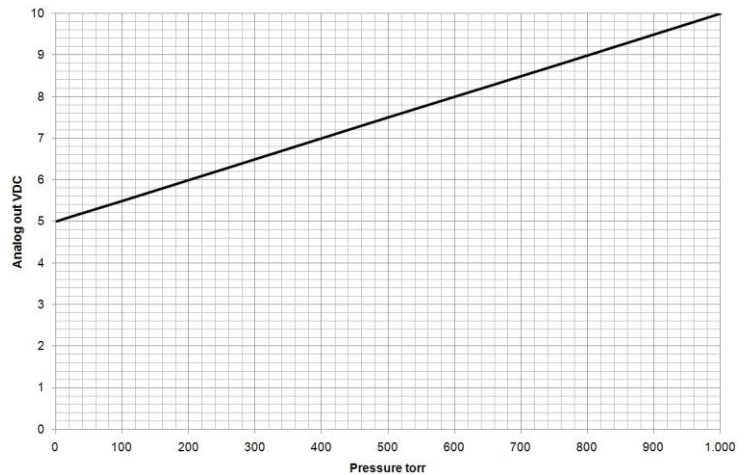

Analog out calibration = 21 (Edwards DV6M)

The Edwards DV6M emulation provides a strongly non linear output with up to 10 Torr.

Torr	mbar	Pascal	Vout
0.0001	1.33E-04	1.33E-02	2
0.0005	6.67E-04	6.67E-02	2.19
0.001	1.33E-03	1.33E-01	2.25
0.002	2.67E-03	2.67E-01	2.38
0.004	5.33E-03	5.33E-01	2.62
0.006	8.00E-03	8.00E-01	2.84
0.008	1.07E-02	1.07E+00	3.06
0.01	1.33E-02	1.33E+00	3.27
0.02	2.67E-02	2.67E+00	4.16
0.04	5.33E-02	5.33E+00	5.56
0.05	6.67E-02	6.67E+00	6.01
0.06	8.00E-02	8.00E+00	6.46
0.08	1.07E-01	1.07E+01	7.04
0.1	1.33E-01	1.33E+01	7.42
0.2	2.67E-01	2.67E+01	8.59
0.4	5.33E-01	5.33E+01	9.4
0.5	6.67E-01	6.67E+01	9.5
0.6	8.00E-01	8.00E+01	9.6
0.8	1.07E+00	1.07E+02	9.71
1	1.33E+00	1.33E+02	9.76
2	2.67E+00	2.67E+02	9.89
4	5.33E+00	5.33E+02	9.96
5	6.67E+00	6.67E+02	9.97
10	1.33E+01	1.33E+03	10

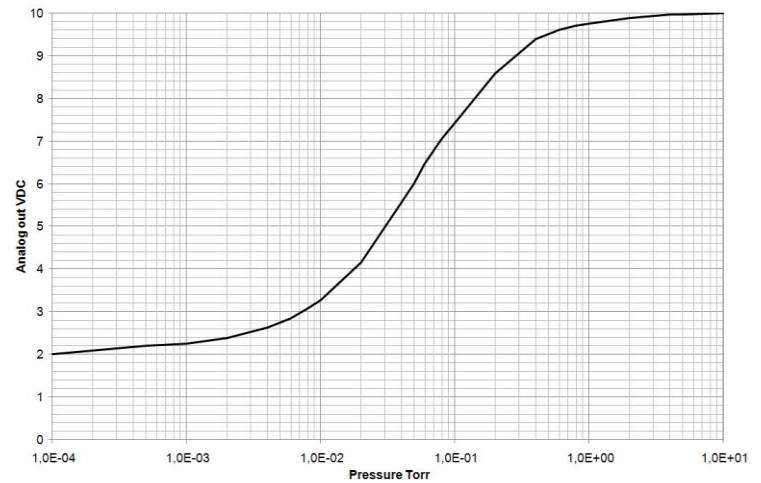

Analog out calibration = 22 (Edwards APG-M)

The Edwards APG-M emulation provides a strongly non linear output.

Torr	mbar	Pascal	Vout
1.00E-4	1.33E-4	1.33E-1	2.0
1.02E-3	1.36E-03	1.36E-01	2.2
7.65E-3	1.02E-02	1.02E+00	3
4.12E-2	5.49E-02	5.49E+00	4
1.32E-1	1.76E-01	1.76E+01	5
5.12E-1	6.83E-01	6.83E+01	6
1.4	1.87E+00	1.87E+02	7
3.29	4.39E+00	4.39E+02	8
9.53	1.27E+01	1.27E+03	9
16.8	2.24E+01	2.24E+03	9.4
26.5	3.53E+01	3.53E+03	9.6
49.9	6.65E+01	6.65E+03	9.8
106	1.41E+02	1.41E+04	9.9
462	6.16E+02	6.16E+04	9.95
760	1.01E+03	1.01E+05	10

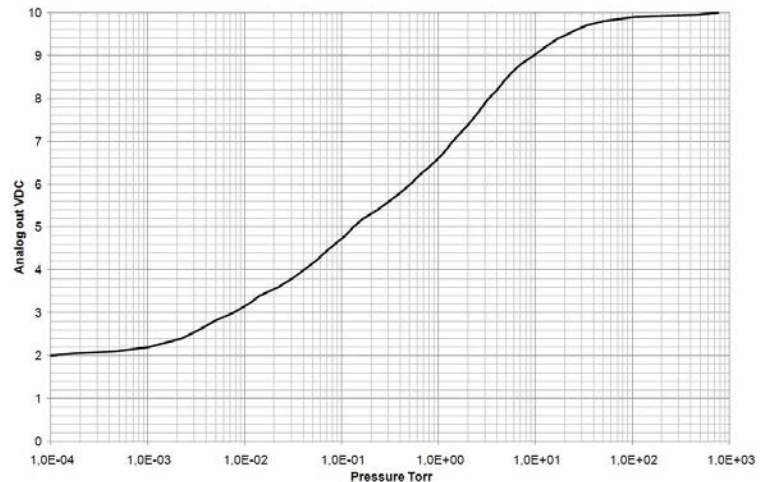

Analog Output calibration = 23 (Brooks / Granville Phillips GP275 Emulation 9 VDC FS)

The GP275 with 9VDC full scale emulation provides a strongly non linear output with very poor resolution in the low range and close to atmospheric pressure.

Torr	mbar	Pascal	Vout
1.00E-03	1.34E-03	1.34E-01	0.015
1.32E-03	1.76E-03	1.76E-01	0.020
3.38E-03	4.51E-03	4.51E-01	0.050
4.81E-03	6.41E-03	6.41E-01	0.070
6.28E-03	8.37E-03	8.37E-01	0.090
7.03E-03	9.37E-03	9.37E-01	0.100
1.52E-02	2.02E-02	2.02E+00	0.200
2.45E-02	3.26E-02	3.26E+00	0.300
3.50E-02	4.66E-02	4.66E+00	0.400
4.67E-02	6.23E-02	6.23E+00	0.500
5.98E-02	7.97E-02	7.97E+00	0.600
7.42E-02	9.90E-02	9.90E+00	0.700
9.01E-02	1.20E-01	1.20E+01	0.800
1.07E-01	1.43E-01	1.43E+01	0.900
1.26E-01	1.68E-01	1.68E+01	1.000
1.69E-01	2.25E-01	2.25E+01	1.200
2.18E-01	2.90E-01	2.90E+01	1.400
2.74E-01	3.65E-01	3.65E+01	1.600
3.53E-01	4.71E-01	4.71E+01	1.846
0.4092	5.46E-01	5.46E+01	2.000
0.4879	6.51E-01	6.51E+01	2.200
0.5755	7.67E-01	7.67E+01	2.400
0.6734	8.98E-01	8.98E+01	2.600
0.7836	1.04E+00	1.04E+02	2.800
0.9076	1.21E+00	1.21E+02	3.000
1.02	1.36E+00	1.36E+02	3.164
1.28	1.71E+00	1.71E+02	3.500
1.77	2.37E+00	2.37E+02	4.000
2.24	2.98E+00	2.98E+02	4.390
3.26	4.34E+00	4.34E+02	5.000
4.57	6.09E+00	6.09E+02	5.500
6.65	8.86E+00	8.86E+02	6.000
10.1	1.34E+01	1.34E+03	6.548
12.9	1.71E+01	1.71E+03	6.800
16.1	2.15E+01	2.15E+03	7.000
29.4	3.92E+01	3.92E+03	7.383
56.6	7.55E+01	7.55E+03	7.647
64.1	8.55E+01	8.55E+03	7.700
114.1	1.52E+02	1.52E+04	7.800
200.7	2.68E+02	2.68E+04	7.910
257.0	3.43E+02	3.43E+04	8.000
314.3	4.19E+02	4.19E+04	8.100
368.5	4.91E+02	4.91E+04	8.200
478.0	6.37E+02	6.37E+04	8.400
606.0	8.08E+02	8.08E+04	8.600
773.1	1.03E+03	1.03E+05	8.800

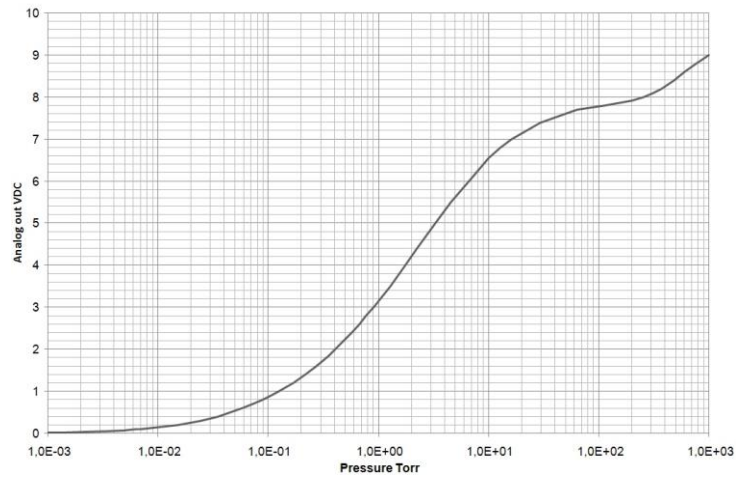

Analog Output calibration = 24 (Thyracont MT241.1-5)

The MT241 emulation provides a strongly non linear output with limited resolution in the low range and close to atmosphere.

Torr	mbar	Pascal	Vout
7.50E-4	1.00E-03	1.00E-01	0.41
3.00E-3	4.00E-03	4.00E-01	0.48
3.75E-3	5.00E-03	5.00E-01	0.5
6.00E-3	8.00E-03	8.00E-01	0.55
7.50E-3	1.00E-02	1.00E+00	0.61
1.50E-2	2.00E-02	2.00E+00	0.79
3.00E-2	4.00E-02	4.00E+00	1.1
4.50E-2	6.00E-02	6.00E+00	1.37
6.00E-2	8.00E-02	8.00E+00	1.6
7.50E-2	1.00E-01	1.00E+01	1.83
1.50E-1	2.00E-01	2.00E+01	2.64
2.25E-1	3.00E-01	3.00E+01	3.2
3.00E-1	4.00E-01	4.00E+01	3.71
3.75E-1	5.00E-01	5.00E+01	4
4.50E-1	6.00E-01	6.00E+01	4.45
6.00E-1	8.00E-01	8.00E+01	5
7.50E-1	1.00E+00	1.00E+02	5.44
3	4.00E+00	4.00E+02	7.96
5	6.00E+00	6.00E+02	8.5
8	1.00E+01	1.00E+03	9.01
15	2.00E+01	2.00E+03	9.45
30	4.00E+01	4.00E+03	9.7
45	6.00E+01	6.00E+03	9.78
75	1.00E+02	1.00E+04	9.85
150	2.00E+02	2.00E+04	9.92
300	4.00E+02	4.00E+04	9.95
450	6.00E+02	6.00E+04	9.96
600	8.00E+02	8.00E+04	9.98
750.06	1.00E+03	1.00E+05	9.99

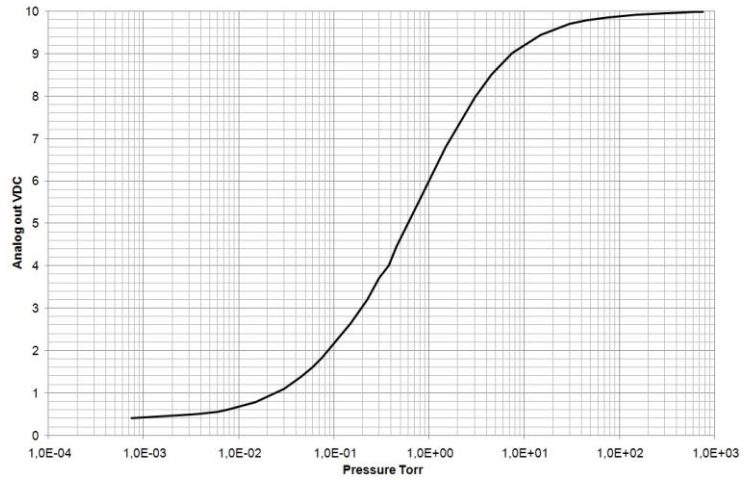

Analog Output calibration = 25 (Brooks / Granville Phillips GP275 Emulation 5.6 VDC FS)

The GP275 emulation with 5.6VDC full scale provides a strongly non linear output with very poor resolution in the low range and close to atmospheric pressure.

Torr	mbar	Pascal	Vout
0.375	1.00E-04	1.33E-04	1.33E-02
0.377	2.00E-04	2.67E-04	2.67E-02
0.379	5.00E-04	6.67E-04	6.67E-02
0.384	1.00E-03	1.33E-03	1.33E-01
0.392	2.00E-03	2.67E-03	2.67E-01
0.417	5.00E-03	6.67E-03	6.67E-01
0.455	1.00E-02	1.33E-02	1.33E+00
0.523	2.00E-02	2.67E-02	2.67E+00
0.682	5.00E-02	6.67E-02	6.67E+00
0.878	1.00E-01	1.33E-01	1.33E+01
1.155	2.00E-01	2.67E-01	2.67E+01
1.683	5.00E-01	6.67E-01	6.67E+01
2.217	1.00E+00	1.33E+00	1.33E+02
2.842	2.00E+00	2.67E+00	2.67E+02
3.675	5.00E+00	6.67E+00	6.67E+02
4.206	1.00E+01	1.33E+01	1.33E+03
4.577	2.00E+01	2.67E+01	2.67E+03
4.846	5.00E+01	6.67E+01	6.67E+03
4.945	1.00E+02	1.33E+02	1.33E+04
5.019	2.00E+02	2.67E+02	2.67E+04
5.111	3.00E+02	4.00E+02	4.00E+04
5.224	4.00E+02	5.33E+02	5.33E+04
5.329	5.00E+02	6.67E+02	6.67E+04
5.419	6.00E+02	8.00E+02	8.00E+04
5.495	7.00E+02	9.33E+02	9.33E+04
5.534	7.60E+02	1.01E+03	1.01E+05
5.558	8.00E+02	1.07E+03	1.07E+05
5.614	9.00E+02	1.20E+03	1.20E+05

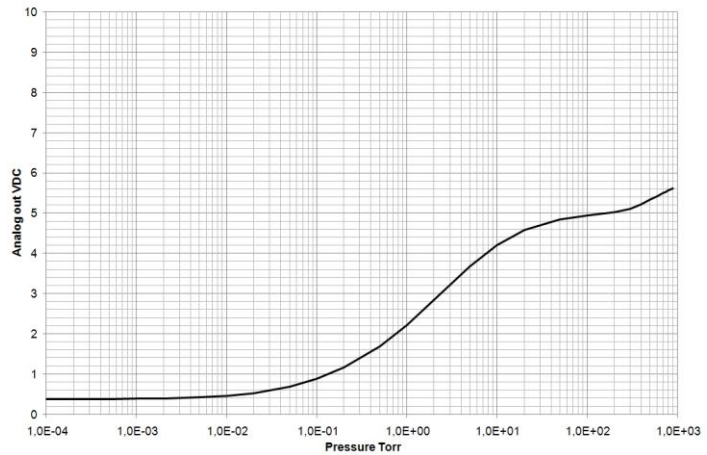

Analog Output calibration = 26 (Edwards APG100-LC)

The APG100-L emulation provides a strongly non-linear output with limited resolution in the low range and close to atmosphere.

Torr	mbar	Pascal	Vout
7.50E-06	1.00E-05	1.00E-03	2
1.70E-04	2.27E-04	2.27E-02	2.1
3.75E-04	5.00E-04	5.00E-02	2.2
8.10E-04	1.08E-03	1.08E-01	2.4
1.26E-03	1.68E-03	1.68E-01	2.6
1.95E-03	2.60E-03	2.60E-01	2.8
2.88E-03	3.84E-03	3.84E-01	3
3.86E-03	5.15E-03	5.15E-01	3.2
5.15E-03	6.87E-03	6.87E-01	3.4
7.88E-03	1.05E-02	1.05E+00	3.6
1.17E-02	1.56E-02	1.56E+00	3.8
1.58E-02	2.10E-02	2.10E+00	4
2.08E-02	2.77E-02	2.77E+00	4.2
2.59E-02	3.45E-02	3.45E+00	4.4
3.12E-02	4.16E-02	4.16E+00	4.6
3.78E-02	5.04E-02	5.04E+00	4.8
4.44E-02	5.92E-02	5.92E+00	5
6.56E-02	8.74E-02	8.74E+00	5.2
9.53E-02	1.27E-01	1.27E+01	5.4
1.28E-01	1.71E-01	1.71E+01	5.6
1.67E-01	2.23E-01	2.23E+01	5.8
2.18E-01	2.90E-01	2.90E+01	6
2.68E-01	3.57E-01	3.57E+01	6.2
3.26E-01	4.35E-01	4.35E+01	6.4
4.00E-01	5.33E-01	5.33E+01	6.6
4.80E-01	6.40E-01	6.40E+01	6.8
5.75E-01	7.67E-01	7.67E+01	7
6.92E-01	9.23E-01	9.23E+01	7.2
8.55E-01	1.14E+00	1.14E+02	7.4
1.05E+00	1.40E+00	1.40E+02	7.6
1.25E+00	1.66E+00	1.66E+02	7.8
1.44E+00	1.92E+00	1.92E+02	8
1.79E+00	2.38E+00	2.38E+02	8.2
2.21E+00	2.95E+00	2.95E+02	8.4
2.63E+00	3.51E+00	3.51E+02	8.6
3.13E+00	4.17E+00	4.17E+02	8.8
4.05E+00	5.40E+00	5.40E+02	9
5.30E+00	7.06E+00	7.06E+02	9.2
7.27E+00	9.69E+00	9.69E+02	9.4
9.68E+00	1.29E+01	1.29E+03	9.5
1.25E+01	1.66E+01	1.66E+03	9.6
1.55E+01	2.07E+01	2.07E+03	9.7
2.54E+01	3.39E+01	3.39E+03	9.8
4.74E+01	6.32E+01	6.32E+03	9.9
1.08E+02	1.44E+02	1.44E+04	9.95
7.60E+02	1.00E+03	1.00E+05	10

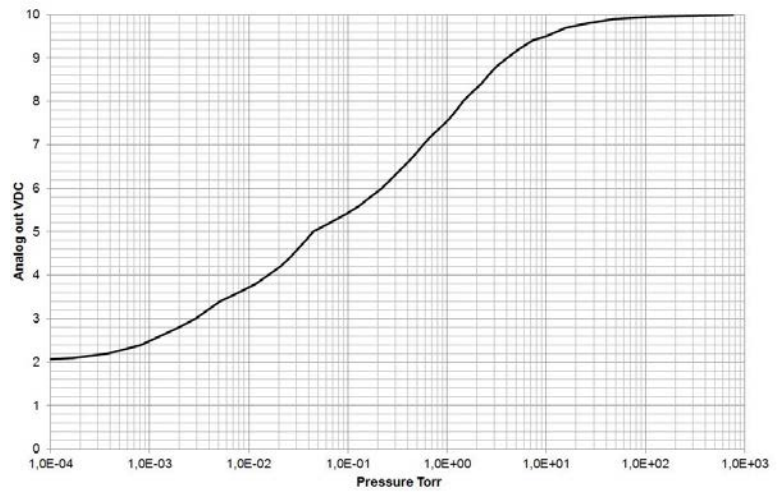

Analog Output calibration = 27 (Edwards APG100-M)

The APG100-M emulation provides a strongly none linear output with limited resolution in the low range and close to atmosphere

Torr	mbar	Pascal	Vout
7.50E-05	1.00E-04	1.00E-02	2
1.73E-04	2.31E-04	2.31E-02	2.05
4.66E-04	6.21E-04	6.21E-02	2.1
1.02E-03	1.36E-03	1.36E-01	2.2
2.23E-03	2.97E-03	2.97E-01	2.4
3.46E-03	4.61E-03	4.61E-01	2.6
4.88E-03	6.51E-03	6.51E-01	2.8
7.65E-03	1.02E-02	1.02E+00	3
1.10E-02	1.47E-02	1.47E+00	3.2
1.43E-02	1.91E-02	1.91E+00	3.4
2.21E-02	2.95E-02	2.95E+00	3.6
3.12E-02	4.16E-02	4.16E+00	3.8
4.21E-02	5.61E-02	5.61E+00	4
5.40E-02	7.20E-02	7.20E+00	4.2
6.71E-02	8.94E-02	8.94E+00	4.4
8.48E-02	1.13E-01	1.13E+01	4.6
1.09E-01	1.45E-01	1.45E+01	4.8
1.32E-01	1.76E-01	1.76E+01	5
1.67E-01	2.22E-01	2.22E+01	5.2
2.37E-01	3.16E-01	3.16E+01	5.4
3.10E-01	4.13E-01	4.13E+01	5.6
4.05E-01	5.40E-01	5.40E+01	5.8
5.12E-01	6.82E-01	6.82E+01	6
6.31E-01	8.41E-01	8.41E+01	6.2
7.95E-01	1.06E+00	1.06E+02	6.4
9.98E-01	1.33E+00	1.33E+02	6.6
1.20E+00	1.60E+00	1.60E+02	6.8
1.40E+00	1.87E+00	1.87E+02	7
1.70E+00	2.26E+00	2.26E+02	7.2
2.06E+00	2.75E+00	2.75E+02	7.4
2.43E+00	3.24E+00	3.24E+02	7.6
2.80E+00	3.73E+00	3.73E+02	7.8
3.29E+00	4.39E+00	4.39E+02	8
3.97E+00	5.29E+00	5.29E+02	8.2
4.70E+00	6.27E+00	6.27E+02	8.4
5.72E+00	7.63E+00	7.63E+02	8.6
7.04E+00	9.39E+00	9.39E+02	8.8
9.53E+00	1.27E+01	1.27E+03	9
1.25E+01	1.67E+01	1.67E+03	9.2
1.68E+01	2.24E+01	2.24E+03	9.4
2.16E+01	2.88E+01	2.88E+03	9.5
2.65E+01	3.53E+01	3.53E+03	9.6
3.36E+01	4.48E+01	4.48E+03	9.7
4.99E+01	6.65E+01	6.65E+03	9.8
1.06E+02	1.41E+02	1.41E+04	9.9
4.62E+02	6.16E+02	6.16E+04	9.95
7.60E+02	1.00E+03	1.00E+05	10

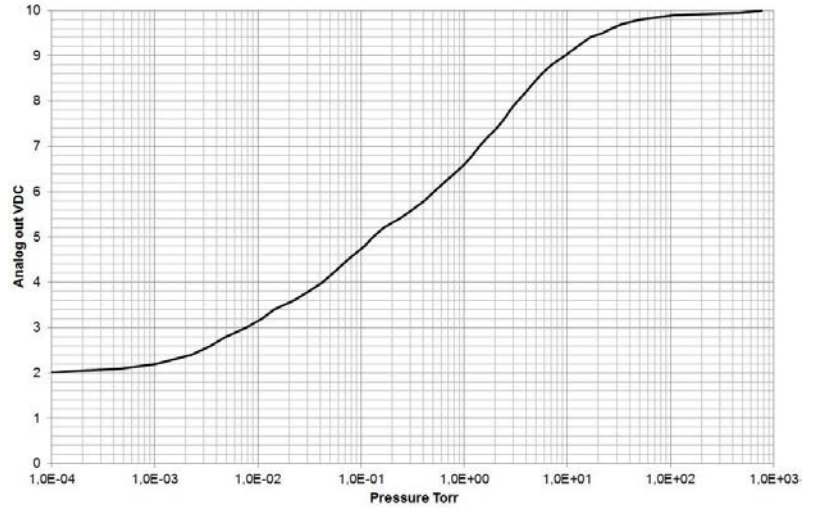

Analog Output calibration = 28 (MKS 907)

Torr	mbar	Pascal	Vout
7.50E-04	1.00E-03	1.00E-01	0.387
1.50E-03	2.00E-03	2.00E-01	0.397
3.00E-03	4.00E-03	4.00E-01	0.418
4.50E-03	6.00E-03	6.00E-01	0.437
6.00E-03	8.00E-03	8.00E-01	0.456
7.50E-03	1.00E-02	1.00E+00	0.473
1.50E-02	2.00E-02	2.00E+00	0.551
2.25E-02	3.00E-02	3.00E+00	0.619
3.00E-02	4.00E-02	4.00E+00	0.679
3.75E-02	5.00E-02	5.00E+00	0.733
4.50E-02	6.00E-02	6.00E+00	0.783
5.25E-02	7.00E-02	7.00E+00	0.83
6.00E-02	8.00E-02	8.00E+00	0.874
6.75E-02	9.00E-02	9.00E+00	0.915
7.50E-02	1.00E-01	1.00E+01	0.955
1.50E-01	2.00E-01	2.00E+01	1.271
2.25E-01	3.00E-01	3.00E+01	1.508
3.00E-01	4.00E-01	4.00E+01	1.701
3.75E-01	5.00E-01	5.00E+01	1.864
4.50E-01	6.00E-01	6.00E+01	2.007
5.25E-01	7.00E-01	7.00E+01	2.133
6.00E-01	8.00E-01	8.00E+01	2.246
6.75E-01	9.00E-01	9.00E+01	2.348
7.50E-01	1.00E+00	1.00E+02	2.442
1.50E+00	2.00E+00	2.00E+02	3.083
2.25E+00	3.00E+00	3.00E+02	3.452
3.00E+00	4.00E+00	4.00E+02	3.698
3.75E+00	5.00E+00	5.00E+02	3.875
4.50E+00	6.00E+00	6.00E+02	4.009
5.25E+00	7.00E+00	7.00E+02	4.114
6.00E+00	8.00E+00	8.00E+02	4.198
6.75E+00	9.00E+00	9.00E+02	4.268
7.50E+00	1.00E+01	1.00E+03	4.327
1.50E+01	2.00E+01	2.00E+03	4.627
1.88E+01	2.50E+01	2.50E+03	4.695
2.25E+01	3.00E+01	3.00E+03	4.743
3.00E+01	4.00E+01	4.00E+03	4.805
3.75E+01	5.00E+01	5.00E+03	4.843
4.50E+01	6.00E+01	6.00E+03	4.872
5.25E+01	7.00E+01	7.00E+03	4.891
5.63E+01	7.50E+01	7.50E+03	4.898
6.00E+01	8.00E+01	8.00E+03	4.904
6.75E+01	9.00E+01	9.00E+03	4.914
7.50E+01	1.00E+02	1.00E+04	4.923
1.50E+02	2.00E+02	2.00E+04	4.987
1.88E+02	2.50E+02	2.50E+04	5.025
2.25E+02	3.00E+02	3.00E+04	5.071
3.00E+02	4.00E+02	4.00E+04	5.183
3.75E+02	5.00E+02	5.00E+04	5.301
4.50E+02	6.00E+02	6.00E+04	5.397
5.25E+02	7.00E+02	7.00E+04	5.478
5.63E+02	7.50E+02	7.50E+04	5.514
6.00E+02	8.00E+02	8.00E+04	5.548
6.75E+02	9.00E+02	9.00E+04	5.61
7.60E+02	1.00E+03	1.00E+05	5.666

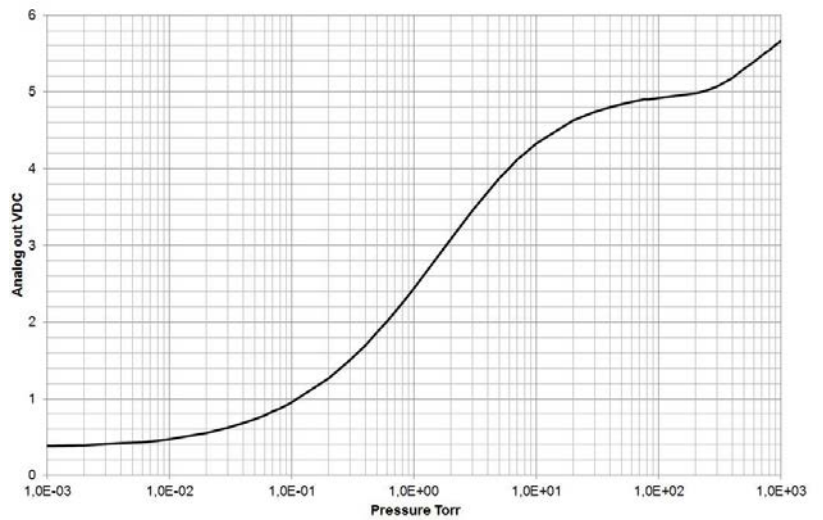

Analog Output calibration = 29 (K6080)

Torr	mbar	Pascal	Vout
7.50E-06	1.00E-05	1.00E-03	0.4
3.75E-05	5.00E-05	5.00E-03	0.4
7.50E-05	1.00E-04	1.00E-02	0.4
3.00E-04	4.00E-04	4.00E-02	0.4
6.00E-04	8.00E-04	8.00E-02	0.4
7.50E-04	1.00E-03	1.00E-01	0.41
3.00E-03	4.00E-03	4.00E-01	0.48
3.75E-03	5.00E-03	5.00E-01	0.5
6.75E-03	9.00E-03	9.00E-01	0.55
1.50E-02	2.00E-02	2.00E+00	0.61
3.75E-02	5.00E-02	5.00E+00	0.79
4.13E-02	5.50E-02	5.50E+00	1.1
4.50E-02	6.00E-02	6.00E+00	1.37
6.00E-02	8.00E-02	8.00E+00	1.6
7.50E-02	1.00E-01	1.00E+01	1.83
1.50E-01	2.00E-01	2.00E+01	2.64
2.60E-01	3.47E-01	3.47E+01	3.2
4.12E-01	5.50E-01	5.50E+01	3.71
5.31E-01	7.08E-01	7.08E+01	4
7.50E-01	1.00E+00	1.00E+02	4.45
1.14E+00	1.51E+00	1.51E+02	5
1.72E+00	2.29E+00	2.29E+02	5.44
3.00E+00	4.00E+00	4.00E+02	6.12
4.50E+00	6.00E+00	6.00E+02	6.8
4.88E+00	6.50E+00	6.50E+02	7.4
5.25E+00	7.00E+00	7.00E+02	7.96
6.00E+00	8.00E+00	8.00E+02	8.5
7.50E+00	1.00E+01	1.00E+03	9.01
1.50E+01	2.00E+01	2.00E+03	9.45
3.00E+01	4.00E+01	4.00E+03	9.7
4.50E+01	6.00E+01	6.00E+03	9.78
7.50E+01	1.00E+02	1.00E+04	9.85
1.50E+02	2.00E+02	2.00E+04	9.92
3.00E+02	4.00E+02	4.00E+04	9.95
4.50E+02	6.00E+02	6.00E+04	9.96
6.00E+02	8.00E+02	8.00E+04	9.98
7.60E+02	1.00E+03	1.00E+05	10

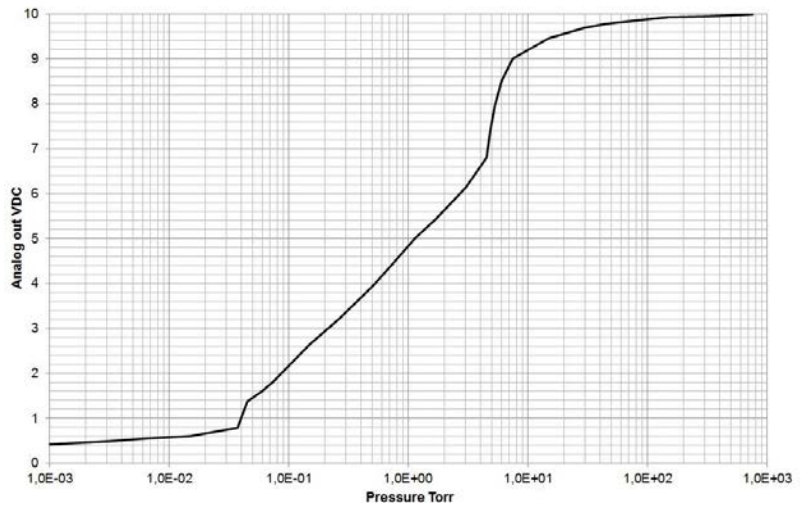

Analog Output calibration = 30 (Inficon PEG100)

Torr	mbar	Pascal	Vout
1.00E-08	1.33E-08	1.33E-06	2.186111
1.00E-07	1.33E-07	1.33E-05	3.516111
1.00E-06	1.33E-06	1.33E-04	4.846111
1.00E-05	1.33E-05	1.33E-03	6.176111
1.00E-04	1.33E-04	1.33E-02	7.506111
5.00E-04	6.67E-04	6.67E-02	8.435741
1.00E-03	1.33E-03	1.33E-01	8.836111
1.00E-02	1.33E-02	1.33E+00	10.16611

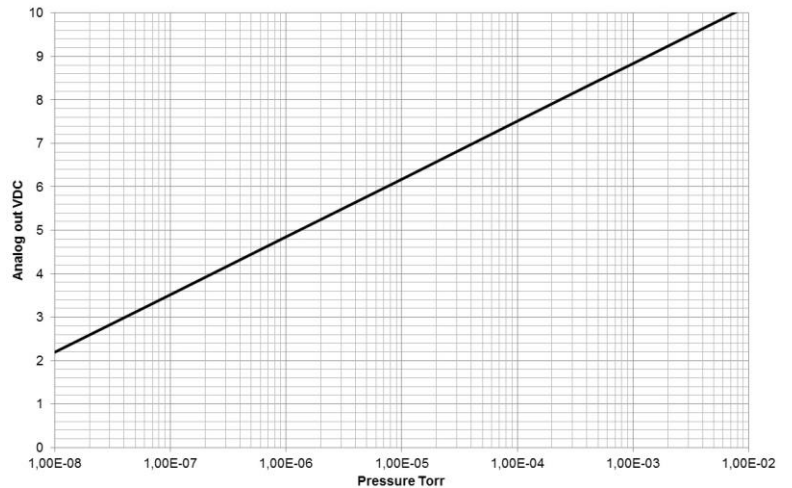

Analog Output calibration = 31 (Varian Eysys)

Torr	mbar	Pascal	Vout
1.00E-04	1.33E-04	1.33E-02	1
1.00E-03	1.33E-03	1.33E-01	2
1.00E-02	1.33E-02	1.33E+00	3
1.00E-01	1.33E-01	1.33E+01	4
1.00E+00	1.33E+00	1.33E+02	5
1.00E+01	1.33E+01	1.33E+03	6
1.00E+02	1.33E+02	1.33E+04	7
1.00E+03	1.33E+03	1.33E+05	8

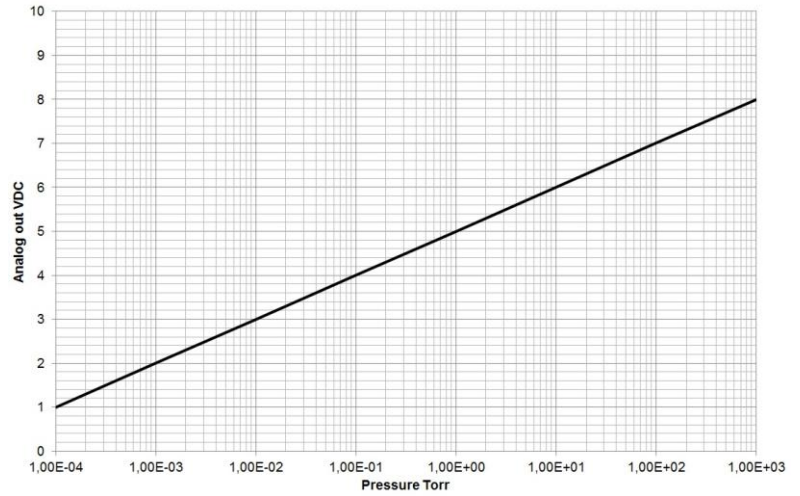

Analog Output calibration = 32 (Alcatel TA111)

Torr	mbar	Pascal	Vout
1.50E-03	2.00E-03	2.00E-01	0.1
2.25E-03	3.00E-03	3.00E-01	0.2
3.00E-03	4.00E-03	4.00E-01	0.3
3.75E-03	5.00E-03	5.00E-01	0.4
4.50E-03	6.00E-03	6.00E-01	0.5
5.25E-03	7.00E-03	7.00E-01	0.6
6.00E-03	8.00E-03	8.00E-01	0.7
6.75E-03	9.00E-03	9.00E-01	0.8
7.50E-03	1.00E-02	1.00E+00	0.9
8.25E-03	1.10E-02	1.10E+00	1
1.50E-02	2.00E-02	2.00E+00	1.8
2.25E-02	3.00E-02	3.00E+00	2.5
3.00E-02	4.00E-02	4.00E+00	3.15
3.75E-02	5.00E-02	5.00E+00	3.65
4.50E-02	6.00E-02	6.00E+00	4.1
5.25E-02	7.00E-02	7.00E+00	4.5
6.00E-02	8.00E-02	8.00E+00	4.85
6.75E-02	9.00E-02	9.00E+00	5.15
7.50E-02	1.00E-01	1.00E+01	5.4
1.50E-01	2.00E-01	2.00E+01	6.95
2.25E-01	3.00E-01	3.00E+01	7.7
3.00E-01	4.00E-01	4.00E+01	8.1
3.75E-01	5.00E-01	5.00E+01	8.4
4.50E-01	6.00E-01	6.00E+01	8.6
5.25E-01	7.00E-01	7.00E+01	8.75
7.50E-01	1.00E+00	1.00E+02	9
1.50E+00	2.00E+00	2.00E+02	9.2
2.25E+00	3.00E+00	3.00E+02	9.2

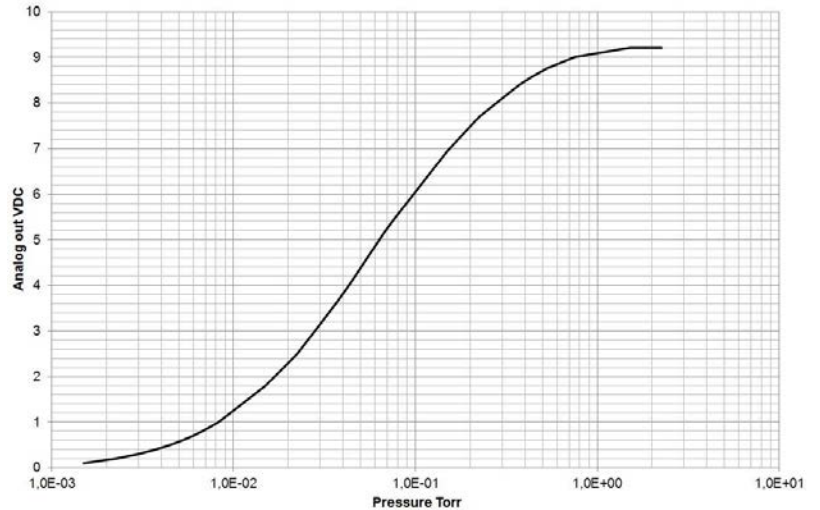

Analog Output calibration = 33 (MKS 685)

$$P = 10^{(V_{out} - 4)}$$

$$V_{out} = 4 + \log_{10}(P)$$

Torr	mbar	Pascal	Vout
1.00E-05	1.33E-05	1.33E-03	1.00
1.00E-04	1.33E-04	1.33E-02	1.00
1.00E-03	1.33E-03	1.33E-01	1.00
1.00E-02	1.33E-02	1.33	2.00
1.00E-01	1.33E-01	13.3	3.00
1.00	1.33	133.3	4.00
10.0	13.3	1333.2	5.00
100	133.3	1.33E+04	6.00
1000	1333.2	1.33E+05	7.00

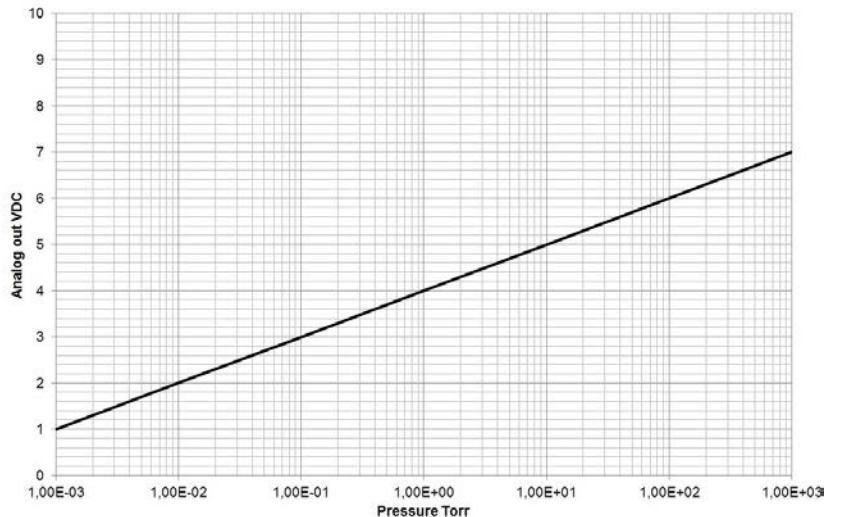

MicroPirani gas dependence

The 974B MicroPirani is based on measurement of thermal conductivity and consequently its reading depends on gas and gas concentration. The 974B has calibration curves for a number of common gases. For gas setup refer to gas calibration page 20.

The 974B is per factory default calibrated for Nitrogen gas and below is showed the 974B Nitrogen MicroPirani reading in different gas types.

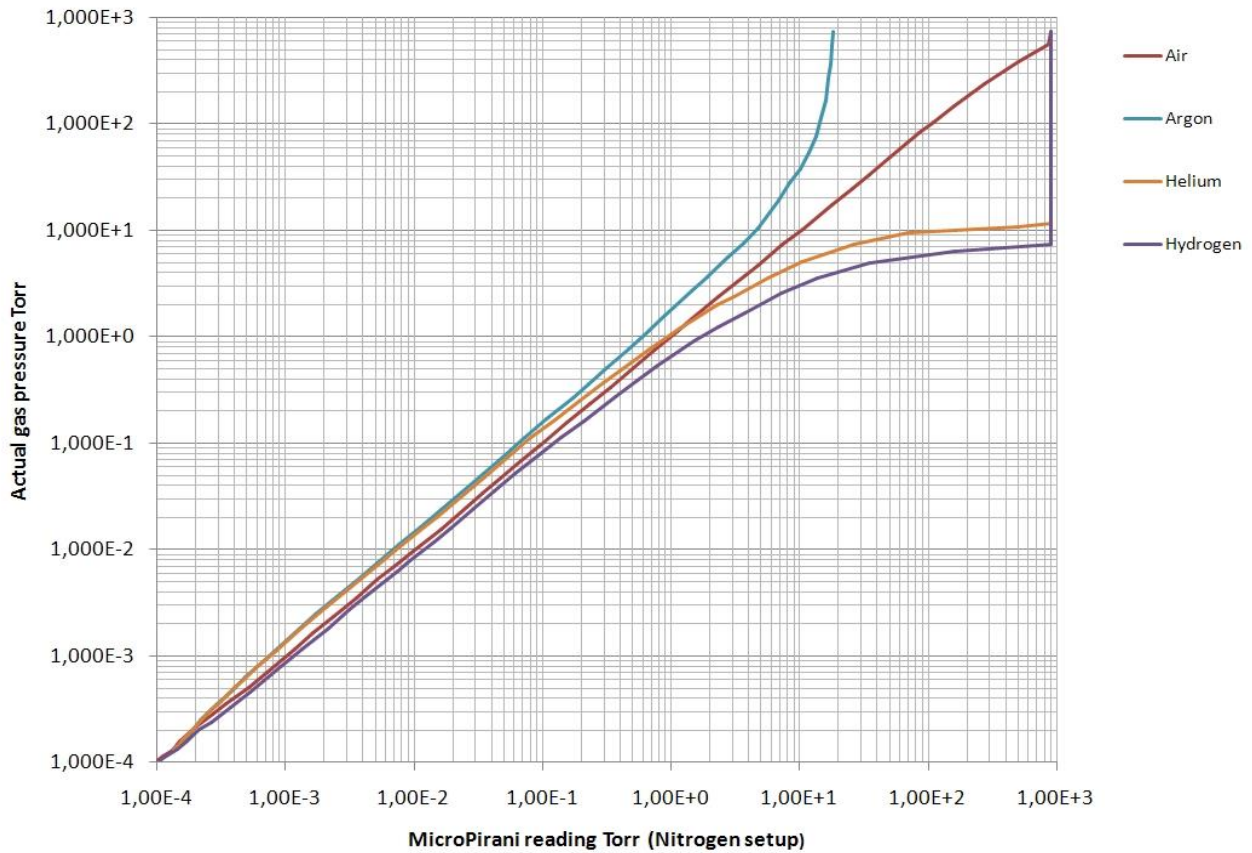

Helium gas dependence

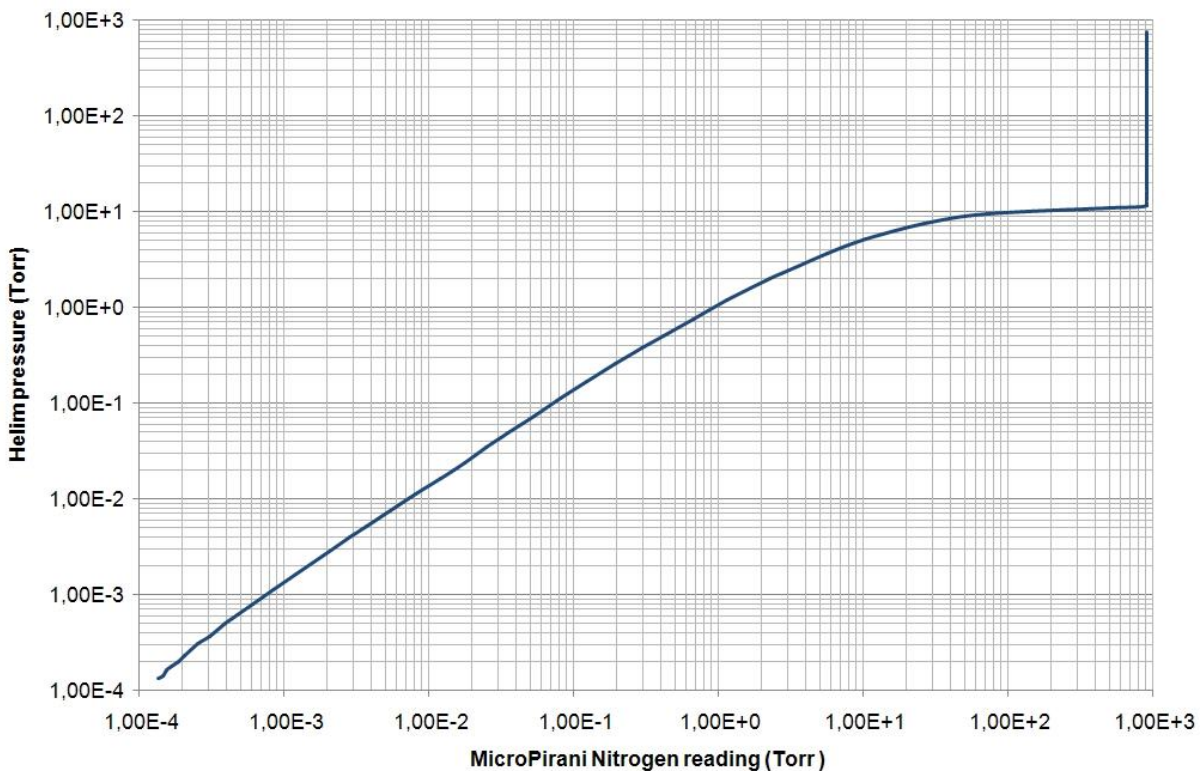

Argon gas dependence

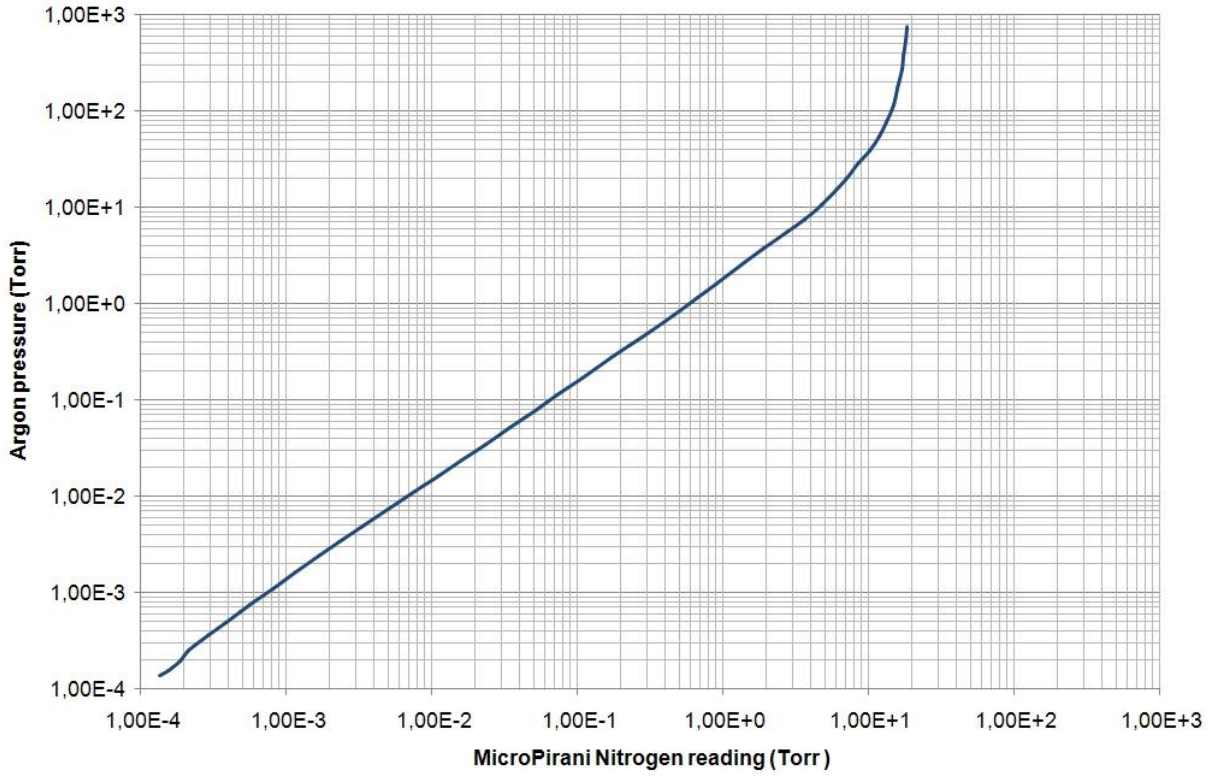

Hydrogen gas dependence

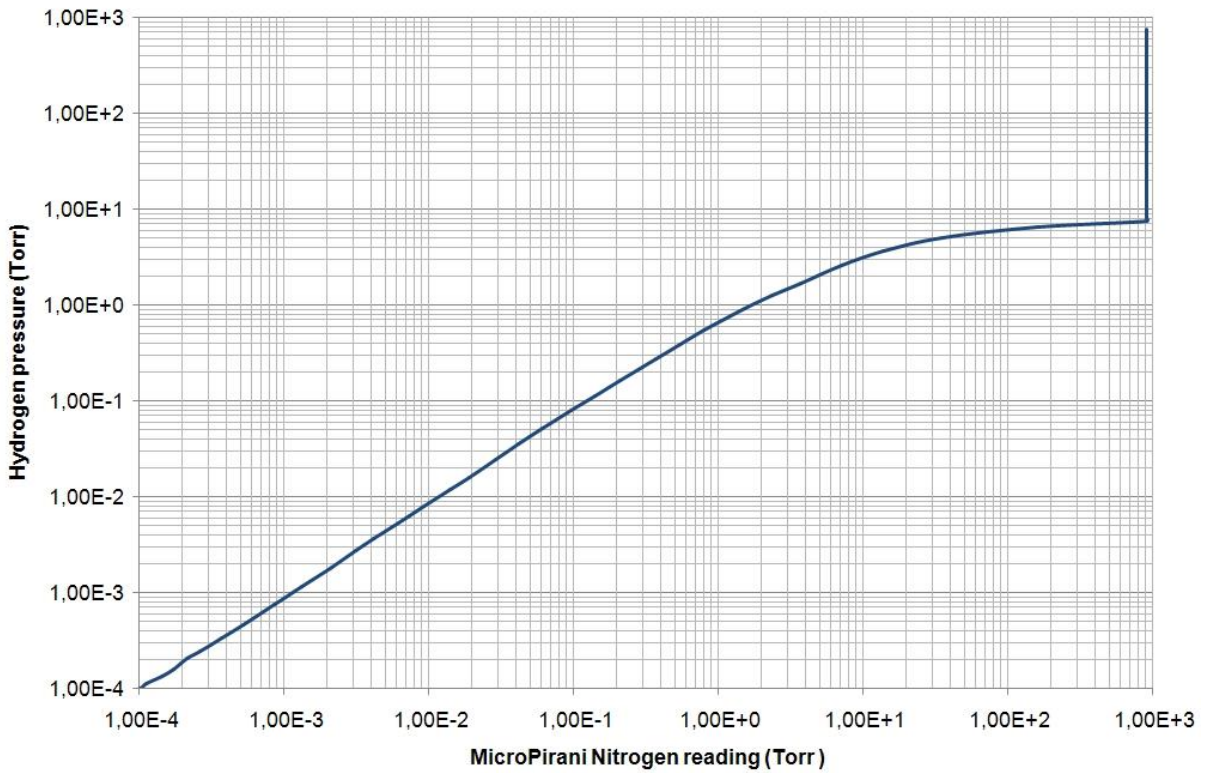

Query Command list

Communication information

Command	Response	Explanation
@xxxBR?;FF	@xxxACK9600;FF	Communication baud rate (4800, 9600, 19200, 38400, 57600, 115200,230400)
@xxxAD?;FF	@xxxACK253;FF	Transducer communication address (001 to 253)
@xxxRSD?;FF	@xxxACKON;FF	Communication delay between receive and transmit sequence.

Pressure reading

Command	Response	Explanation
@xxxPR1?;FF	@xxxACK1.23E-3;FF	MicroPirani sensor pressure as 3 digit floating point value.
@xxxPR2?;FF	@xxxACK-7.60E+2;FF	Piezo differential sensor pressure as 3 digit floating point value.
@xxxPR3?;FF	@xxxACK1.23E-3;FF	Combined reading as 3 digit floating point value.
@xxxPR4?;FF	@xxxACK1.234E-3;FF	Combined reading as 4 digit floating point value.
@xxxPR5?;FF	@xxxACK1.234E-3;FF	Cold Cathode sensor pressure as 3 digit floating point value.

Setpoint information

Command	Response	Explanation
@xxxSS1?;FF @xxxSS2?;FF @xxxSS3?;FF	@xxxACKSET;FF	Setpoint relay 1-3 status (SET=Relay energized / CLEAR=Relay deenergized)
@xxxSP1?;FF @xxxSP2?;FF @xxxSP3?;FF	@xxxACK1.00E-2;FF	Setpoint 1-3 switch value.
@xxxSH1?;FF @xxxSH2?;FF @xxxSH3?;FF	@xxxACK1.10E-2;FF	Setpoint 1-3 hysteresis switch value.
@xxxEN1?;FF @xxxEN2?;FF @xxxEN3?;FF	@xxxACKOFF;FF	Setpoint 1-3 enable status (OFF, PIR=MicroPirani, CC=Cold Cathode, DIFF=Piezo differential or CMB=Combined)
@xxxSD1?;FF @xxxSD2?;FF @xxxSD3?;FF	@xxxACKBELOW;FF	Setpoint relay direction (ABOVE or BELOW) If set to above relay will be energized above setpoint value. If set to below relay will be energized below setpoint value.

Transducer information

Command	Response	Explanation
@xxxMD?;FF	@xxxACK974B;FF	Model number (974B)
@xxxDT?;FF	@xxxACKQuadMag;FF	Device type name (MicroPirani)
@xxxMF?;FF	@xxxACKMKS;FF	Manufacturer name (MKS)
@xxxHV?;FF	@xxxACKA;FF	Hardware version
@xxxFV?;FF	@xxxACK1.12;FF	Firmware version
@xxxSN?;FF	@xxxACK08350123456;FF	Serial number
@xxxSW?;FF	@xxxACKON;FF	Switch enable
@xxxTIM?;FF	@xxxACK123;FF	Time on (hours of operation)
@xxxTIM2?;FF	@xxxACK24;FF	Cold cathode high voltage time on (hours of operation)
@xxxTIM3?;FF	@xxxACK1.00E-2;FF	Cold cathode pressure dose
@xxxTEM?;FF	@xxxACK2.50E+1;FF	MicroPirani sensor temperature
@xxxUT?;FF	@xxxACKVACUUM1;FF	User programmed text string (user tag)
@xxxT?;FF	@xxxACKO;FF	Transducer status check

Calibration and adjustment information

Command	Response	Explanation
@xxxU?;FF	@xxxACKTORR;FF	Pressure unit setup (Torr, mbar or Pascal)
@xxxGT?;FF	@xxxACKNITROGEN;FF	MicroPirani sensor calibration gas (Nitrogen, Air, Argon, Helium, Hydrogen, H2O, Neon, CO2, Xenon)
@xxxVAC?;FF	@xxxACK5.12E-5;FF	Provides delta pressure value between current MicroPirani vacuum zero adjustment and factory calibration.
@xxxVAC3?;FF	@xxxACK5.12E-8;FF	Provides delta pressure value between current cold cathode vacuum zero adjustment and factory calibration.
@xxxATM?;FF	@xxxACK1.22E+1;FF	Provides pressure factor value between current atmospheric adjustment and factory calibration.
@xxxCFS?;FF	@xxxACK1.01E+0;FF	Provides pressure factor value between current Cold cathode full scale adjustment and factory calibration.
@xxxAO1?;FF	@xxxACK30;FF	Analog voltage output 1: Pressure assignment and calibration. (first digit is pressure assignment, second and third digit is calibration)
@xxxAO2?;FF	@xxxACK30;FF	Analog voltage output 2: Pressure assignment and calibration. (first digit is pressure assignment, second and third digit is calibration)

Setup and configuration command list

Setpoint setup and configuration

Command	Response	Explanation
@xxxSP1!2.00E+1;FF @xxxSP2!2.00E+1;FF @xxxSP3!2.00E+1;FF	@xxxACK2.00E+1;FF	Setpoint 1-3 switch value.
@xxxSH1!5.00E+1;FF @xxxSH2!5.00E+1;FF @xxxSH3!5.00E+1;FF	@xxxACK5.00E+1;FF	Setpoint 1-3 hysteresis switch value.
@xxxEN1!ON;FF @xxxEN2!ON;FF @xxxEN3!ON;FF	@xxxACKON;FF	Setpoint 1-3 enable status (ON or OFF)
@xxxSD1!BELOW;FF @xxxSD2!BELOW;FF @xxxSD3!BELOW;FF	@xxxACKBELOW;FF	Setpoint relay direction (ABOVE or BELOW) If set to above relay will be energized above setpoint value. If set to below relay will be energized below setpoint value.
@xxxSPD!ON;FF	@xxxACKON;FF	Setpoint safety delay (prevent pulse trig of setpoint)

Communication setup

Command	Response	Explanation
@xxxBR!19200;FF	@xxxACK19200;FF	Set communication Baud rate (4800, 9600, 19200, 38400, 57600, 115200, 230400)
@xxxAD!123;FF	@xxxACK123;FF	Set Transducer communication address (001 to 253)
@xxxRSD!OFF;FF	@xxxACKOFF;FF	Turn on or off communication delay between receive and transmit sequence.

Calibration and adjustment

Command	Response	Explanation
@xxxU!MBAR;FF	@xxxACKMBAR;FF	Set pressure unit setup (Torr, mbar, Pascal)
@xxxGT!ARGON;FF	@xxxACKARGON;FF	Set MicroPirani sensor calibration gas. (Nitrogen, Air, Argon, Helium, Hydrogen, H2O, Neon, CO2, Xenon)
@xxxVAC!;FF	@xxxACK;FF	Executes MicroPirani zero adjustment
@xxxATM!7.60E+2;FF	@xxxACK;FF	Executes MicroPirani full scale atmospheric adjustment.
@xxxVAC3!;FF	@xxxACK;FF	Executes Cold Cathode zero adjustment
@xxxCFS!4.00E-3;FF	@xxxACK;FF	Executes Cold Cathode full scale adjustment.
@xxxATD!7.60E+2;FF	@xxxACK;FF	Executes Piezo absolute reading at zero differential pressure.
@xxxATZ;FF	@xxxACK;FF	Executes Piezo differential zero adjustment
@xxxAO1!10;FF	@xxxACK10;FF	Set analog voltage output 1 calibration.
@xxxAO2!10;FF	@xxxACK10;FF	Set analog voltage output 2 calibration.
@xxxMZL!1.00E-4;FF	@xxxACK1.00E-4;FF	MicroPirani auto zero limit

Information setup

Command	Response	Explanation
@xxxUT!QUADMAG;FF	@xxxACKQUADMAG;FF	Set transducer user tag

User Switch

Command	Response	Explanation
@xxxSW!ON;FF	@xxxACKON;FF	Enable / disable user switch

Cold Cathode setup

Command	Response	Explanation
@xxxSLC!5.00E-4;FF	@xxxACK5.00E-4;FF	CC turn on pressure
@xxxSHC!8.00E-4;FF	@xxxACK8.00E-4;FF	CC turn off pressure
@xxxSLP!1.00E-4;FF	@xxxACK1.00E-4;FF	Setpoint low CC/MP integration
@xxxSHP!4.00E-4;FF	@xxxACK4.00E-4;FF	Setpoint high CC/MP integration
@xxxPRO!240;FF	@xxxACK240;FF	Cold cathode protect setpoint time and enable
@xxxPD!1.00E-2;FF	@xxxACK1.00E-2;FF	Cold cathode pressure dose setpoint

xxx = Transducer communication address (001 to 253, Broadcast addresses: 254, 255)

Firmware upgrades (RS232 only)

The 910 firmware can be upgraded by the user. The following procedure should be used:

1. Install the 900 Series firmware download software from the Documentation CD or download from www.mksinst.com/vtsw/
2. Turn power off
3. Hold down the User switch while turning power on
4. Release the User switch
5. Run the 900 Series firmware download software and start download

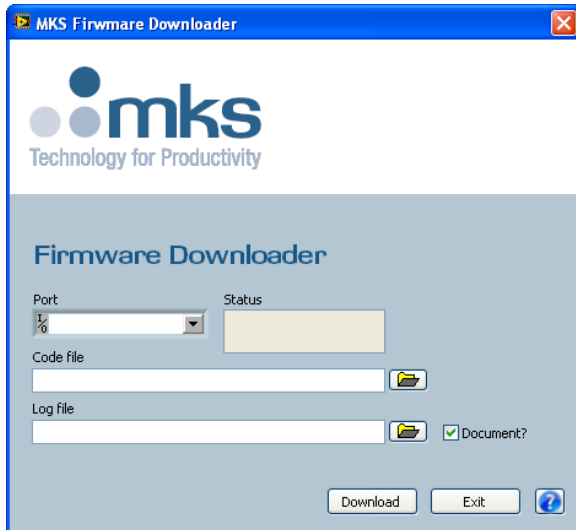

Transducer with RS485 interface cannot be firmware upgraded by the user. Contact MKS customer service for upgrade.

FAQ (Frequently Asked Questions)

Applications

Q: *Can the transducer and sensor element continuously withstand vibrations from a mechanical fore-pump.*

A: Yes – the MEMS MicroPirani sensor element and cold cathode sensor can withstand continuous vibrations.

Q: *Is the transducer compatible with fluorine gases?*

A: No – the 974B is not intended for use in aggressive environments like semiconductor etch applications.

Q: *When the transducer is pumped down and isolated by closing a valve the pressure is raising. Is the transducer leaking?*

A: Not likely - when a confined space is evacuated and the pumping is stopped the pressure will rise because of out gassing, mainly by water vapor. The pressure can easily rise to a few Torr over time.

Q: *When the transducer is leak checked on a helium leak detector, leak reading is building up slowly after approximately 30 seconds. Is the transducer leaking?*

A: No - the internal sealing of the 974B transducer uses elastomer viton sealing and consequently helium molecules can penetrate through the viton material and cause slow increase of helium leak readout. If a leaking transducer is tested directly on a helium leak detector the leak is almost instant displayed.

Q: *Can the transducer be mounted in any orientation?*

A: Yes - the transducer can be mounted in any orientation without compromise of performance or calibration. However it is recommended not to mount the transducer with the flange port facing upwards to avoid contamination like particulates or liquids from entering the device.

Q: *Can the transducer withstand instant ventilation?*

A: Yes - the MicroPirani and Cold cathode sensor elements are extremely robust to mechanical forces and can withstand continuously pressure cycles and instant air ventilation. It's not recommended to perform instant ventilation when the Cold Cathode is turned on.

Q: *Can I connect a valve to be controlled by the transducer relay contact?*

A: Driving inductive loads such as valves requires special precautions. Refer to detailed description page 12.

Q: *How many pressure cycles can the transducer withstand?*

A: Both the MicroPirani and Cold Cathode sensor element is very mechanical robust to pressure changes and there are no limits on the number of pressure cycles. In applications where fast pressure cycles occur, the Cold Cathode sensor can be sputtered and this can lead to change of accuracy.

Q: *The Cold Cathode sensor chamber has changed color, Why?*

A: If the Cold Cathode is operated at high pressure ($>1.00E-4$ Torr) the inside walls of the cold cathode ionization cell can be sputtered. This will change the color of the internal measuring chamber and can also result in change of measuring accuracy.

Analog output

Q: *What is the update rate of the analog output?*

A: 16 times per second.

Q: *What is the maximum length of analog output cable?*

A: The length of analog cable depends on cable quality and electrical noise environment, but cable length up to 100 m do not normally require any special precautions other than the cable must be screened.

Q: *The digital reading is correct but the analog output reading has some deviation from actual pressure?*

A: Check that the analog out is connected to a floating input and not an input that is connected to ground. If connected analog out return is connected to ground, the supply current will flow in the signal line and cause voltage drop and ground looping.

Digital output

Q: *How fast can I request pressure measurements via the digital interface?*

A: 10 times per second is the fastest recommended pressure request frequency.

Q: *How long is the waiting time from turning power on to valid measuring values?*

A: The power on sequence is approximately 2 seconds. The LED is illuminating red during power up sequence and the digital interface will not reply to commands.

Q: *The first character is sometimes lost in the transducer digital communication reply?*

A: This can be caused by too fast transducer communication reply. See RS delay command description page 11.

Q: *Is it necessary to use the ground wire between RS485 communication equipment and transducer?*

A: Yes - both RS232 and RS485 communication requires a 3 wire connection between transducer and communication equipment.

Calibration and adjustment

Q: *How often does the transducer require calibration or Zero adjustment?*

A: It depends on the application and pressure range but in many applications user adjustment is never required. Factors that temporally or permanently can influence the measuring performance are contamination, corrosion, heat and electronic interference. The MicroPirani is automatically zero adjusted whenever the pressure measured by the cold cathode is below the MicroPirani zero limit.

Q: *How long is the warm up time before obtaining reliable measurements from the transducer?*

A: The small mass of the MicroPirani sensor element ensures short sensor warm up time. Reliable measurements are typically available within 1 minute. The cold cathode has a stabilization of a few minutes after turning the high voltage on.

Q: *Will the transducer retain user calibration after power is shut off?*

A: Yes - all transducer parameters including calibration data are stored internally in the transducer non volatile memory.

Q: *The 974B MicroPirani (PR1) reads 900 Torr at atmospheric pressure of 760 Torr?*

A: The MicroPirani is based on measurement of thermal conductivity and if exposed to ambient pressure the higher thermal conductivity of air will cause the transducer to read higher values. The transducer is per factory default calibrated with Nitrogen.

Service and repair

Q: *Can the sensor element be changed if contaminated?*

A: No - the sensor elements cannot be changed without its measuring electronics. The transducer flange assembly can be exchanged with the 974B repair kit. Refer to Service and Repair page 56.

Q: *+24 VDC supply voltage has been connected to analog output+. Is the transducer damaged?*

A: Likely - the analog output is not protected against applying power to the output pin.

Q: *Reverse voltage has been connected to power supply input. Is the transducer damaged?*

A: Not likely – the transducer power supply circuit has reverse voltage and over voltage protection however. MKS cannot guarantee that the transducer will not be damaged.

Q: *The status LED is constantly illuminating red?*

A: The red status indicates a defect MicroPirani sensor element most likely damaged by corrosion or contamination. Refer to Service and Repair page 56.

Trouble shooting

Symptom	Possible Cause/Remedy
No digital communication	<ul style="list-style-type: none"> - Check electrical connections (3 wires from transducer to communication equipment) - Transducer and communication equipment baud rate matches - Use of incorrect transducer address. Try address 254 - Attention characters missing (@) - Termination characters missing (;FF)
NAK180 is received when transmitting setpoint commands	<ul style="list-style-type: none"> - The transducer setup is locked. Refer to disable lock procedure page 25
Incorrect pressure value	<ul style="list-style-type: none"> - Other gas present than transducer gas setting or trace of gas. - Contaminated sensor. Transducer repair required. - Corroded sensor. Transducer repair required.
Incorrect pressure value at low pressure.	<ul style="list-style-type: none"> - Contaminated sensor. Transducer repair required. - Corroded sensor. Transducer repair required. - Incorrect Vac adjustment has been executed. - Transducer exposed to heat or cooling air stream.
Incorrect pressure value at high pressure.	<ul style="list-style-type: none"> - Contaminated sensor. Transducer repair required. - Corroded sensor. Transducer repair required. - Incorrect ATM adjustment has been executed. - Other gas or gas trace present than transducer gas setting.
Cold Cathode does not provide measurements.	<ul style="list-style-type: none"> - If the Cold cathode is turned on a low pressure $<1.00E-7$ Torr or is contaminated a delay can occur from turning on high voltage to the ionization begins.
Cold Cathode value is lower than actual pressure.	<ul style="list-style-type: none"> - If the Cold Cathode sensor has been operated a too high pressure or exposed to fast pressure cycles the sensor can be sputtered. Sputtering of sensor will normally provide lower reading than actual pressure.
Setpoint relay does not trip.	<ul style="list-style-type: none"> - Setpoint not enabled. - Setpoint value not set to proper value. - Setpoint direction is different than the user expects. - Check electrical connection. - Check part number to see if transducer has setpoint relays.
No analog output	<ul style="list-style-type: none"> - Power supply turned off. - Check electrical connections.
Status LED illuminating red	<ul style="list-style-type: none"> - Sensor element defect. Refer to Service and Repair page 56.

Service and Repair

The 974B Transducer repair kit includes the flange and calibrated sensor (1) electronics and can be used for quick and easy customer in-field service of the 974B Transducer. After the installation of the repair kit the transducer will be operating as a new transducer. Transducers with integrated display (P/N: 901P-xxxx4 and 901P-xxxx6) cannot be disassembled by user and must sent to MKS service facility for repair.

974B Transducer repair kit

Part number	Description
974B-2REP	974B Sensor repair kit. KF25 flange
974B-7REP	974B Sensor repair kit. CF2.75" flange
974B-9REP	974B Sensor repair kit. KF40 flange



Before disassembling the transducer take precautions to avoid static discharge which can damage the electronics. Use grounded wrist band if available.

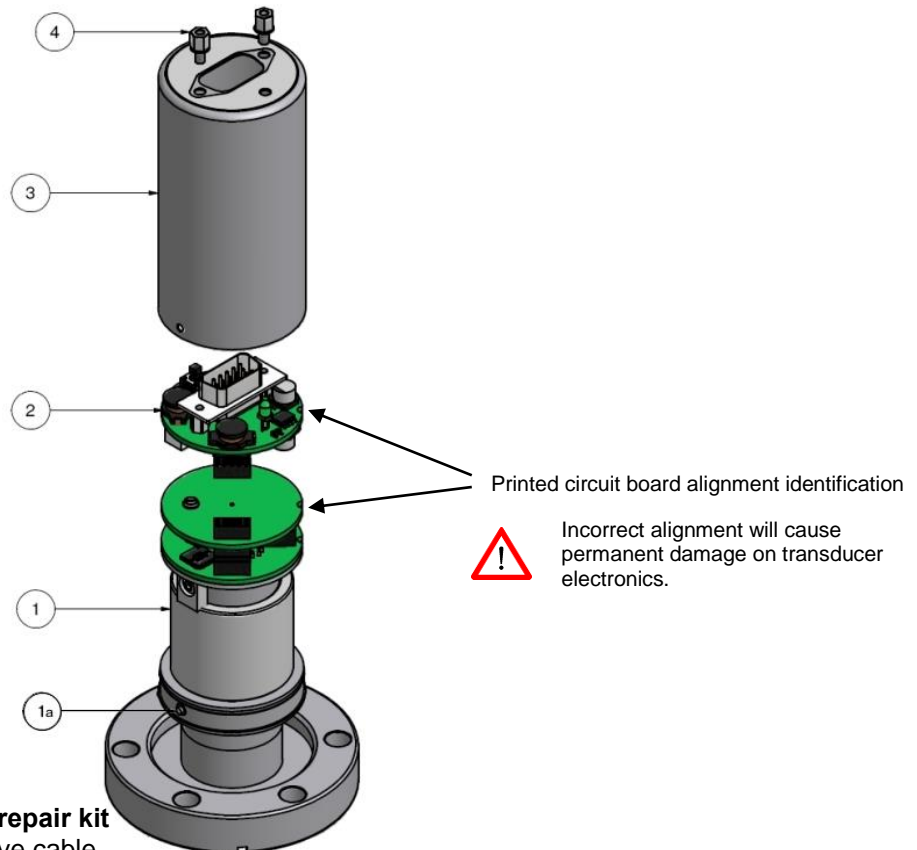

Installing the 974B transducer repair kit

1. Turn power off and remove cable.
2. Dismount the transducer from the vacuum system.
3. Unscrew the two hex screws (4) at the DSUB connector using a 5mm hex screw driver.
4. Use a paper clip, a small screwdriver or similar tool to press down the two mounting taps (1a) on the side.
5. Carefully remove the enclosure (3).
6. Remove the top circuit board (2).
7. Mount the top circuit board (2) on the new 974B Sensor repair kit flange and make sure the printed circuit board alignment identifications match the two boards.
8. Carefully assemble the enclosure (3) and make sure the mounting taps (1a) click out.
9. Mount the two hex screws (4).
10. If required, reenter transducer setpoints, unit, gas type and other application parameters.



The 974B Sensor repair kit flange does not have customer setup or configuration parameters (like setpoint settings); it is always delivered with factory default parameters.



The exchanged flange assembly should not be disposed in the normal unsorted waste stream. It should be deposited at an appropriate collection point or facility to enable recovery or recycling.

974B Cold cathode maintenance

When a Cold Cathode sensor is turned on and operated at pressures higher than $1.0E-3$ Torr, the inside wall of the ionization chamber can be sputtered by ions formed by the high energetic plasma. Inert gases like argon are easier to ionize and consequently the sputter effect is more significant in such environment. If the transducer is contaminated, the pressure measurement will typically be lower than actual pressure. Sputtering can also be visually detected since the inside wall of the transducer changes color. When operated in oil lubricated pumping systems, hydrocarbons can cause contamination of cold cathode measuring cell. The cold cathode hour counter and pressure dose can be used to determine if service is required. (See page 17 and 26)

If sputtering or contamination occurs, the ionization cell kit or anode module can be changed from the flanges side without disassembling of the transducer. The anode module (p/n: 970B-ANODE⁽¹⁾) and cell kit (p/n: 970B-CELLKIT) is available as spare parts. The basic accuracy of the cold cathode sensor can change after replacement of anode. The cell kit and anode module can also be cleaned by mechanical polishing.

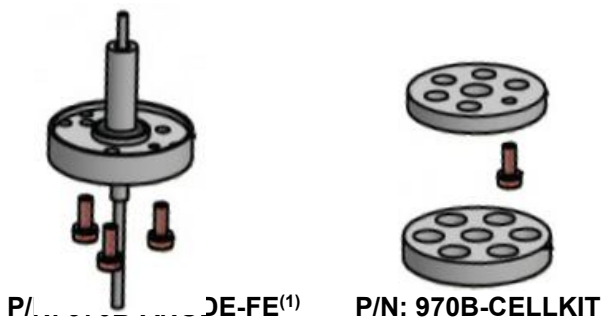

Do not touch cell kit, anode module, screen, screws or clip ring by hand. If items are accidentally touched by hand, use alcohol to clean items.



Changing the Cell kit

1. Turn power off and remove cable.
2. Dismount the transducer from the vacuum system.
3. Remove the clip ring (1) using a clip ring remove/insert tool (p/n: 100017193).
4. Remove the screen (2).
5. Unscrew the Torx (T6) screws (3) at the rear screen (4).
6. Remove the rear screen (4).
7. Insert the new screen (Do not touch by hand).
8. Insert the Torx (T6) screw (3) and tighten.
9. Insert the front screen (2) and clip ring (1).

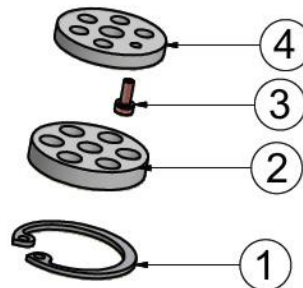

Changing the Anode

1. Remove cell kit point 1-6
2. Unscrew the 3 screws at the anode module.
3. Remove the anode module and clean module or insert new.
4. Insert the anode module screw and DO NOT tighten. After all screws are inserted carefully tighten the screw a little and move on to the next one. Continue to tighten the screws one by one until all tight.
5. Perform leak testing of transducer.
6. Insert cell kit point 7-9.

Cleaning anode module and screens

Contaminated parts can be cleaned by mechanical polishing or ultra sonic cleaned followed by alcohol degreasing. Make sure that all parts are clean and remove any discoloring of the stainless steel and titanium parts. Alternatively the anode module or screens can be replaced with new parts.

Specifications

Measuring range (N₂ and Air):

1×10^{-8} Torr to 1500 Torr

Measuring range differential (Gas independent)		-760 to +760 Torr
MicroPirani		
Accuracy ⁽¹⁾ (N ₂)	1×10 ⁻⁴ to 1×10 ⁻³ Torr:	±10% of reading
	1×10 ⁻³ to 100 Torr:	± 5% of reading
	100 Torr to Atm.:	± 25% of reading
Repeatability ⁽¹⁾ (N ₂):	1×10 ⁻³ to 100 Torr:	± 2% of reading
Cold cathode		
Accuracy Cathode ⁽¹⁾	1×10 ⁻⁸ to 1×10 ⁻³ Torr:	±30% of reading
Piezo Differential		
Accuracy Piezo ⁽¹⁾	-10 to +10 Torr:	±10% of reading + ±5×10 ⁻¹ Torr
	-100 to -10 Torr:	± 8% of reading
	-760 to -100 Torr:	± 1% of reading
	+10 to 100Torr:	± 5% of reading
Repeatability ⁽¹⁾ (N ₂):	-760 to +10 Torr	± 1% of reading
Supply Voltage:		9 – 30 VDC
Power consumption:		< 2 Watt
Fuse (thermal recoverable):		200 mA
Analog output (MKS standard):		1-9 VDC
Analog output 1 resolution:		16 bit
Analog output 2 resolution:		12 bit
Analog output impedance:		100 Ω
Analog output update rate:		16 Hz
Setpoint relay range:		1×10 ⁻⁸ to 500 Torr
Setpoint relay contact rating:		1A / 30 VDC/ac (resistive load)
Setpoint relay contact resistance:		100 mΩ (max)
Setpoint relay contact endurance (30VDC/1A load):		100.000 (min)
Setpoint relay contact endurance (30VDC/0.2A load):		2.000.000 (min)
Setpoint relay response time:		<100 ms
Materials exposed to vacuum:		304 stainless steel 403 stainless steel Ceramic (Al ₂ O ₃) Silicon, SiO ₂ , Si ₃ N ₄ , Gold, Viton®, Low out gassing epoxy resin
Internal volume:	KF25 flange	28.6 cm ³
	CF2.75" flange	20.7 cm ³
	KF40 flange	21.7 cm ³
Housing material:		Stainless steel 304
Flange material:		Stainless steel 304
Weight:	KF25 flange	360 g
	CF2.75" flange	570 g
	KF40 flange	390 g
Operating temperature:		0 to 40 °C (32 to 104 °F)
Bake out temperature (Power off):		85 °C (185 °F)
Humidity:		0 – 95% Non-condensing
Ingress Protection Rating:		IP40

(1) Accuracy and repeatability are typical values measured in Nitrogen atmosphere after zero adjustment at ambient temperature.

Dimensions KF25 flange (P/N: 974B-2xxx)
mm. [Inch.]

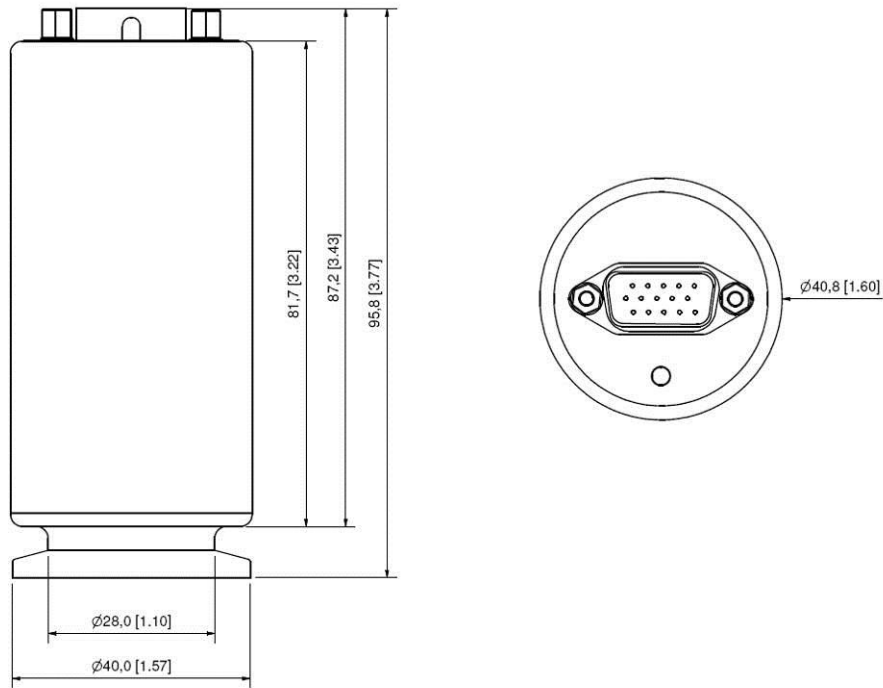

Dimensions CF2.75" flange (P/N: 974B-7xxx)
mm. [Inch.]

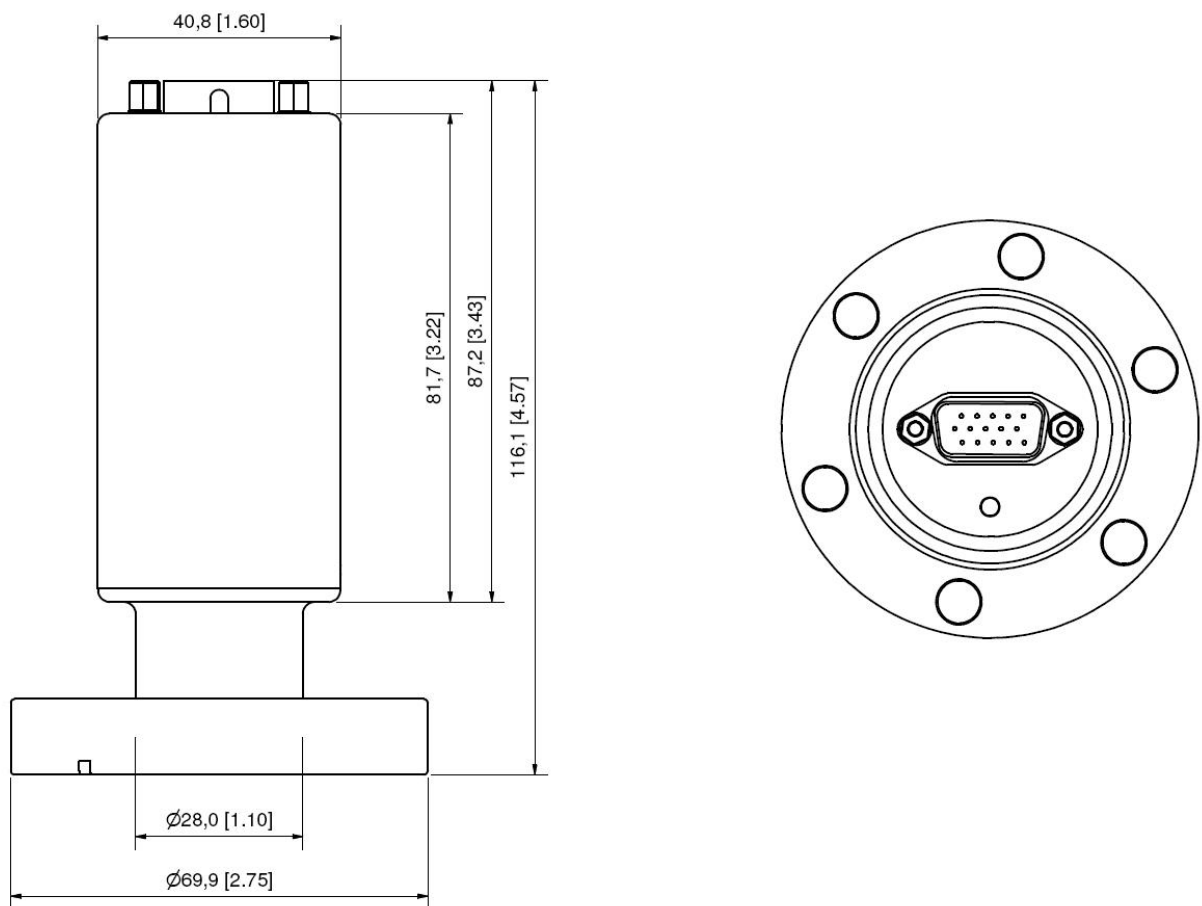

Dimensions KF40 flange (P/N: 974B-9xxx)

mm. [Inch.]

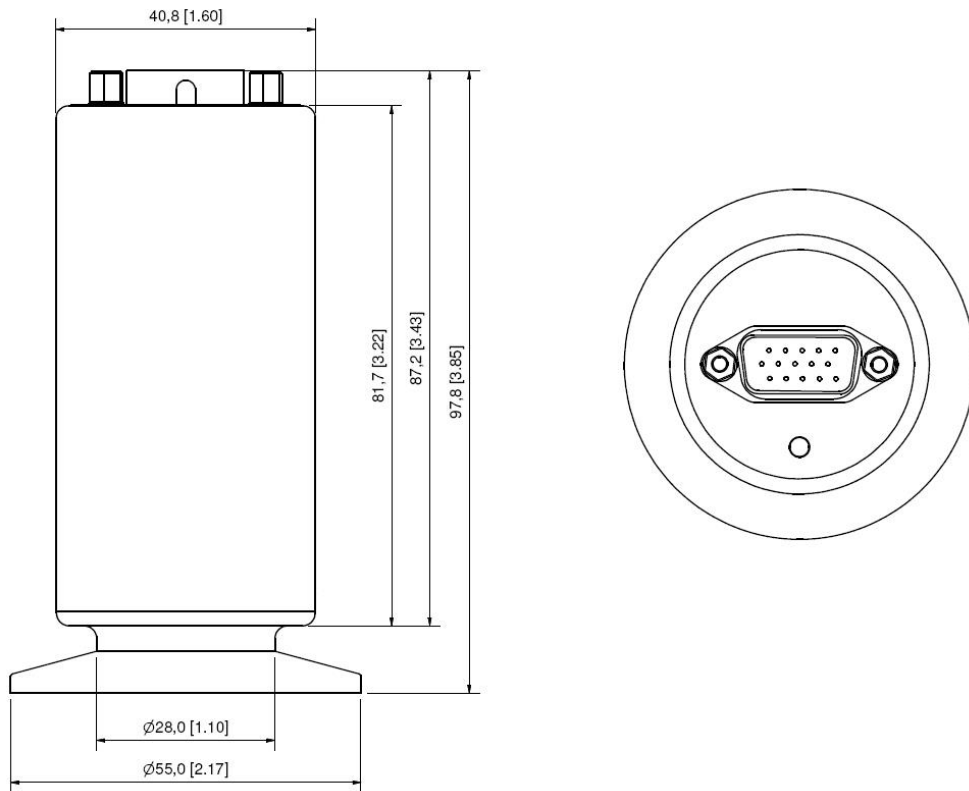

Accessories and replacement part numbers

PDR900 controller

Part number	Description	Interface
PDR900-12-EU	PDR900 Controller	EU Schuko power cable
PDR900-12-US	PDR900 Controller	US power cable
PDR900-12-UK	PDR900 Controller	UK power cable
PDR900-12-JP	PDR900 Controller	JP power cable. mbar / Pascal unit
PDR900-12-DK	PDR900 Controller	Danish power cable



PDR900 Transducer Cables for 974B (15 pin HD DSUB)

For transducer part number: 974B-x12x. 974B-x13x. 974B-x15x

Part number	Description	Interface
100013620	3 m (10ft.)	RS232
100013621	5 m (16ft.)	RS232
100013622	7.6m (25ft.)	RS232
100013623	10 m (33ft.)	RS232

For transducer part number: 974B-x22x. 974B-x23x. 974B-x25x

Part number	Description	Interface
100013671	3 m (10ft.)	RS485
100013672	5 m (16ft.)	RS485
100013673	7.6m (25ft.)	RS485
100013674	10 m (33ft.)	RS485

PDR900 Connectors & cables

Part number	Description
100010757	Setpoint Relay 3 pin connector
100013638	Analog output 8 pin connector
100013686	Analog output cable 3 meter (10ft.)
100013693	RS232/RS485 user communication cable 3 meter (10ft.)

PDR900 Mounting hardware

Part number	Description
100013689	¼.19" Rack mounting kit
100013690	Panel mounting kit
100013691	Front panel protection panel
100013692	Front panel protection panel w/key

RS232 Cable for Hirschmann and RJ45/FCC68 Transducers

Part number	Description
100013367	Cable RS232, 3m

974B Transducer calibration certificate

Part number	Description
100013147	DKD Calibration certificate Europe
100013200	Internal Calibration certificate Europe

974B Transducer repair kit

Part number	Description
974B-2REP	974B Sensor repair kit. KF25 flange
974B-7REP	974B Sensor repair kit CF2.75"flange
974B-9REP	974B Sensor repair kit. KF40 flange
970-ANODEKIT-FE	Anode kit for 970 Series cold cathode Transducers
100017192	Torx Driver, for Anode change
100017193	Circlip ring plier

CE Declaration of Conformity

Manufacturer: **MKS Denmark ApS
Ndr. Strandvej 119G
DK-3150 Hellebaek
Denmark**



Model: **974B QuadMag**

Type of Equipment: **Vacuum pressure transducer**

Application of Council Directive(s): **2004/108/EC Electromagnetic Compatibility**

Standard(s) to which conformity is declared:

EN61326-1:2006 EMC requirements for electrical equipment for measurement, control and laboratory use. (Industrial location).

Emissions

EN 55011:1997 Limits and Methods of measurements of radio disturbances characteristic of industrial, scientific, and medical RF equipment (Class B, Group 1)

Immunity

EN 61000-4-2 Electrostatic discharge
EN 61000-4-3 Radiated RF electromagnetic fields
EN 61000-4-4 EFT/burst
EN 61000-4-6 Conducted disturbances by RF fields

Safety

EN 61010-1:2001 Safety Requirements for Electrical Equipment for Measurement, Control, and Laboratory Use

I, the undersigned, hereby declare that the equipment above conforms to the above Directive(s) and Standard(s) when installed in accordance with specifications specified in this short form manual and Operation and Installation manual.

MKS Denmark ApS. Hellebaek. Denmark
July 1, 2009

Ole Wenzel – Managing Director

PDR 900 Display and power supply

- Plug and play readout for 900 Series transducers
- The easy way for setup and configuration
- Data logger tool for data analysing



See more on: www.mksinst.com/pdr900

900 Series VacuumLog software

- Data logger software
- Pressure curve plotting
- Rate of raise diagnostic tool
- Pump down monitoring
- Export of data to Excel spread sheet
- Windows 7 compatible

Free trial version available on:
<http://www.mksinst.com/vtsw/>



Index

Accessories and replacement part numbers	61	Manufacturer	26
Accuracy	58	Model	26
Accuracy and repeatability.....	20	Moducell 325.....	34
Addressing.....	11	NAK Code	10
Analog output.....	27; 53	NAK180.....	13; 25; 55
Applications	4; 53	Operating temperature.....	58
Argon gas	49	Part number	3
Atmospheric adjustment	22	Part Number.....	26
Auto Zero Adjustment	21	PDR900	61; 63
Bake out.....	6	PDR900 controller relays	12
Bake out temperature	58	Piezo analog output	37
Baud rate	11	Pressure output.....	15
Calibration and adjustment.....	20	Process compatibility	6
Calibration certificate	61	Query Command list	50
CE Declaration of Conformity	62	Repair	56
CE marking	2	Repeatability	58
Cold Cathode setup	18	RS232 user interface	9
Communication delay	11	RS485 user interface	9
Communication Protocol.....	10	Safety information	2
Communication software	10	Sensor Check	26
Contamination.....	6	Sensor technology	4
Device Type.....	26	Serial Number	26
Dimensions	59	Serial user interface	9
Disposal	4	Service and repair.....	2; 54; 56
Dual Analog output	29	Setpoint functionality.....	12
Explosive Environments	2; 6	Setpoint relay	12
Factory default	24	Setup and configuration command list.....	51
Firmware upgrade.....	5; 52	Specifications.....	58
Firmware Version.....	26	Supply Voltage.....	58
Frequently Asked Questions	53	Temperature	6; 26
Fuse	2; 58	Termination resistor	9
Gas calibration	20	Time ON.....	26
Gas dependence	48	Transducer installation (electrical)	7
Grounding	2	Transducer installation (mechanical)	6
Hardware Version	26	Trouble shooting	55
Helium gas.....	48	Unit calibration	20
Hydrogen gas	49	Unpacking	3
Inductive relay load.....	12	User Switch.....	5; 25
Input/Output Wiring.....	8	Vacuum connections.....	6
Internal volume	58	Vibrations	6
LED Status Indicator.....	5	Warranty	2
Lock function.....	25	Zero Adjustment.....	21
Magnetic interference	2		

**P/N: 100017137
974B QuadMag™ Transducer
Operation and Installation Manual
Revision: G, September 2014**