

MKS Type P3B and P4B
Digital
Mass Flow Controllers
Instruction Manual

WARRANTY

Type P3B and P4B Mass Flow Controllers

MKS Instruments, Inc. (MKS) warrants that for one (1) year from the date of shipment the equipment described above (the “equipment”) manufactured by MKS shall be free from defects in materials and workmanship.

For the period commencing with the date of shipment of this equipment and ending one (1) year later, MKS will, at its option, either repair or replace any part which is defective in materials or workmanship without charge to the purchaser. The foregoing shall constitute the exclusive and sole remedy of the purchaser for any breach of MKS of this warranty.

The purchaser, before returning any equipment covered by this warranty, which is asserted to be defective by the purchaser, shall make specific written arrangements with respect to the responsibility for shipping the equipment and handling any other incidental charges with the MKS Sales Representative or distributor from which the equipment was purchased or, in the case of a direct purchase from MKS, with the MKS home office in Andover, Massachusetts, USA.

This warranty does not apply to any equipment which has not been installed and used in accordance with the specifications recommended by MKS for the proper and normal use of the equipment. MKS shall not be liable under any circumstances for indirect, special, consequential, or incidental damages in connection with, or arising out of, the sale, performance, or use of the equipment covered by this warranty.

MKS recommends that all MKS pressure and flow products be calibrated periodically (typically) every 6 to 12 months) to ensure accurate readings. When a product is returned to MKS for this periodic re-calibration it is considered normal preventative maintenance not covered by any warranty.

THIS WARRANTY IS IN LIEU OF ALL OTHER RELEVANT WARRANTIES, EXPRESSED OR IMPLIED, INCLUDING THE IMPLIED WARRANTY OF MERCHANTABILITY AND THE IMPLIED WARRANTY OF FITNESS FOR A PARTICULAR PURPOSE, AND ANY WARRANTY AGAINST INFRINGEMENT OF ANY PATENT.

Copyright © 2013 by MKS Instruments, Inc.

All rights reserved. No part of this work may be reproduced or transmitted in any form or by any means, electronic or mechanical, including photocopying and recording, or by any information storage or retrieval system, except as may be expressly permitted in writing by MKS Instruments, Inc.

Printed in the United States of America

Baratron® and Mass-Flo® are registered trademarks of MKS Instruments, Inc., Andover, MA

DeviceNet™ is a trademark of Open DeviceNet Vendor Association, Inc., Coral Springs, FL

Elgiloy is a registered trademark of Elgiloy Specialty Metals, Elgin, IL

Teflon® is a registered trademark of E.I. du Pont de Nemours and Company, Wilmington, DE

Swagelok® and VCR® are registered trademarks of Swagelok Marketing Company, Solon, OH

Protected by U. S. Patents 5314164 and 5461913

Table of Contents

List of References	v
Mass Flow Device Safety Information	1
Symbols Used in This Instruction Manual	1
Symbols Found on the Unit.....	1
Safety Procedures and Precautions.....	1
Sicherheitshinweise für das Massenflussgerät	3
In dieser Betriebsanleitung vorkommende Symbole	3
Erklärung der am Gerät angebrachten Symbole	3
Sicherheitsvorschriften und Vorsichtsmaßnahmen	3
Informations de sécurité pour appareils de mesure/contrôle de débit massique	5
Symboles utilisés dans ce manuel d'utilisation.....	5
Symboles figurant sur l'unité.....	5
Mesures de sécurité et précautions	5
Medidas de seguridad del dispositivo de flujo de masa	7
Símbolos usados en este manual de instrucciones.....	7
Símbolos hallados en la unidad	7
Procedimientos y precauciones de seguridad	7
マスフロー機器の安全に関する情報	9
本取扱説明書のマーク	9
本機器のマーク	9
安全対策について	10
질량 유량 장치 안전 정보	13
본 지침 매뉴얼에 사용되는 기호들	13
장치에 표시된 기호들	13
안전 절차 및 예방조치	14
Chapter One: General Information	17
Introduction	17
How This Manual is Organized.....	18
Customer Support.....	19
Chapter Two: Overview	21
General Information	21
How the MFC Works	22
Operation of the MFC with Gases other than Nitrogen.....	23
Chapter Three: Installation and Configuration	24
Unpacking	24
Product Location and Requirements.....	25
Dimensions - P4B.....	26

Dimensions - P3B.....	30
Installation Procedure.....	32
Chapter Four: Analog and Digital Interface	35
Analog I/O Interface Cables.....	35
Analog Interface Input and Output Options.....	36
Digital Interface Input and Output Options.....	39
Chapter Five: Ethernet Interface Setup and Configuration	47
Step 1: Install the Java™ Plug-in (for single IP address).....	47
Step 2: Setup Network for Communication through Ethernet.....	48
Chapter Six: Embedded Web-Based GUI and Diagnostics.....	57
Logging On to Your MFC.....	57
Monitor Mode.....	57
Setup Mode.....	63
Tuning the MFC for Optional PC.....	72
Chapter Seven: Maintenance	76
General Information.....	76
Recalibration.....	76
Flow Zero Adjustment.....	76
Chapter Eight: Troubleshooting.....	81
Troubleshooting Chart.....	81
Appendix A: Product Specifications.....	89
Performance Specifications –P4B/P3B.....	89
Specifications are subject to change without notice. Mechanical Specifications.....	89
Mechanical Specifications.....	90
Electrical Specifications.....	90
Appendix B : Model Code Explanation.....	93
Model Code Description.....	93
Appendix C: Health and Safety Form.....	100

List of Figures

Figure 1: 4-VCR Front View - (Normally Closed Valve)	26
Figure 2: 4-VCR DeviceNet Inlet End (Left) and Outlet End (Right) Views - (Normally Closed Valve).....	26
Figure 3: 4-VCR Inlet End - 15 pin D and 9 pin D Views (Normally Closed Valve)	27
Figure 4: 4-VCR Bottom View	27
Figure 5: C or W Seal Side View – Normally Closed	28
Figure 6: C or W Seal DeviceNet Inlet End (Left) and Outlet End (Right) Views – Normally Closed Valve.	28
Figure 7: C and W Seal Bottom View	29
Figure 8: 4-VCR DeviceNet Top View	29
Figure 9: 4-VCR 9 pin D and 15 pin D Top View.....	29
Figure 10: 4-VCR DeviceNet	30
Figure 11: VCR DeviceNet Inlet End (Left) and Outlet End (Right) Views.....	30
Figure 12: 4-VCR Bottom View	31
Figure 13: Serial Number Label (sample).....	31
Figure 14: Devicenet MAC ID Switches	33
Figure 15: DeviceNet Connector Pin Diagram	40
Figure 16: Devicenet Baud Rate Switch	41
Figure 17: Devicenet MAC ID Switches	42
Figure 18: RS485 Baud Rate Switch	44
Figure 19: RS485 MACID Switches	44
Figure 20: Embedded GUI, MFC Device Page in Monitor Mode	58
Figure 21: Embedded GUI, Plot Page in Monitor Mode	60
Figure 22: Embedded GUI, Diagnostics Page	61
Figure 23: Embedded GUI, Configuration Page in Monitor Mode	62
Figure 24: Setup Mode (Configuration Page).....	63
Figure 25: Embedded GUI, Device Page in Setup Mode	65
Figure 26: Embedded GUI, Creating A New Gas Instance	65
Figure 27: Changing the Full Scale Flow Range	66
Figure 28: Embedded GUI, Plot Page in Setup Mode	67
Figure 29: Embedded GUI, Configuration Page in Setup Mode	68
Figure 30: Embedded GUI, Optional PC Page in Setup Mode (15 pin D Analog Only)	70
Figure 31: Embedded GUI, Plot Page with Enabled Optional Input (15 pin D Analog Only).....	71
Figure 32: Effects of the Proportional Control	72
Figure 33: Effects of the Integral Control.....	73

List of Tables

Table 1: Definition of Symbols Found on the Unit.....	1
Tabelle 2: Bedeutung der am Gerät angebrachten Symbole	3
Tableau 3: Définition des symboles sur l'unité.....	5
Tabla 4: Definición de los símbolos hallados en la unidad	7
表 5: 本機器に使用されているマークについて	9
표 6: 장치에 표시된 기호들의 정의	13
Table 7: MKS Interface Cables	35
Table 8: Analog Interface – 9 Pin D Males Pinouts – Model Code A	36
Table 9: Analog Interface – 15 Pin D Males Pinouts – Model Code B.....	37
Table 10: Digital Interface - DeviceNet Connector Pinout – Model Code 6	39
Table 11: Network Status LED Indicators	40
Table 12: Digital Interface – RS485 Using 9 Pin D – Model Code 5	43
Table 13: RS485 Module Status LED Indicators	44
Table 14: Troubleshooting Chart.....	81

List of References

The documents listed below are referenced throughout this manual.

- [1] “DeviceNet Specification, Volume I: DeviceNet Communication Model and Protocol”, Open DeviceNet Vendors Association, Inc. Release 2.0. ERRATA 4.0
- [2] “DeviceNet Specification, Volume II: DeviceNet Profiles and Object Library”, Open DeviceNet Vendors Association, Inc. Release 2.0. ERRATA 4.0
- [3] “Sensor/Actuator Network Common Device Model”, SEMI Standards Document E54.1-0097.
- [4] “Sensor/Actuator Network Communications Standard for DeviceNet”, SEMI Standards Draft Document E54.4-0097.
- [5] “Sensor/Actuator Network Specific Device Model for Mass Flow Devices”, SEMI Standards Draft Document #2253C.
- [6] “Sensor/Actuator Network Standard”, SEMI Standards Document E54-0097.
- [7] SEMI E17-00-0060 Guideline for Mass Flow Controller Transient Characteristics Tests
- [8] SEMI E18-00-0091. Guideline for Temperature Specifications of the Mass Flow Controller
- [9] SEMI E27-00-0092. Standard for Mass Flow Controller and Mass Flow Meter Linearity
- [10] SEMI E28-00-0092. Guideline for Pressure Specifications of the Mass Flow Controller
- [11] SEMI E56-00-1296. Test Method for Determining Accuracy, Linearity, Repeatability, Short Term Reproducibility, Hysteresis, and Dead Band of Thermal Mass Flow Controllers
- [12] SEMI Standards Document E52-95.
- [13] SEMI E80-00-0299. Test Method Determining Attitude Sensitivity of Mass Flow Controllers
- [14] SEMI Standards Document E52-95. Practice for Referencing Gases and Gas Mixtures Used in Digital Mass Flow Controllers

This page intentionally left blank.

Mass Flow Device Safety Information

Symbols Used in This Instruction Manual

Definitions of WARNING, CAUTION, and NOTE messages used throughout the manual.



Warning

The **WARNING** sign denotes a hazard. It calls attention to a procedure, practice, condition, or the like, which, if not correctly performed or adhered to, could result in injury to personnel.



Caution

The **CAUTION** sign denotes a hazard. It calls attention to an operating procedure, practice, or the like, which, if not correctly performed or adhered to, could result in damage to or destruction of all or part of the product.















Note

The **NOTE** sign denotes important information. It calls attention to a procedure, practice, condition, or the like, which is essential to highlight.

Symbols Found on the Unit

The following table describes symbols that may be found on the unit.

Table 1: Definition of Symbols Found on the Unit

 On (Supply) IEC 417, No. 5007	 Off (Supply) IEC 417, No. 5008	 Earth (ground) IEC 417, No. 5017	 Protective Earth (ground) IEC 417, No. 5019
 Frame or Chassis IEC 417, No. 5020	 Equipotentiality IEC 417, No. 5021	 Direct Current IEC 417, No. 5031	 Alternating Current IEC 417, No. 5032
 Both Direct and Alternating Current IEC 417, No. 5033-a	 Class II Equipment IEC 417, No. 5172-a	 Three Phase Alternating Current IEC 617-2, No. 020206	
 Caution (refer to accompanying documents) ISO 3864, No. B.3.1	 Caution, Risk of Electric Shock ISO 3864, No. B.3.6	 Caution, Hot Surface IEC 417, No. 5041	

Safety Procedures and Precautions

Observe the following general safety precautions during all phases of operation of this instrument. Failure to comply with these precautions or with specific warnings elsewhere in this manual violates safety standards of intended use of the instrument and may impair the protection provided by the equipment. MKS Instruments, Inc. assumes no liability for the customer's failure to comply with these requirements.

DO NOT SUBSTITUTE PARTS OR MODIFY INSTRUMENT

Do not install substitute parts or perform any unauthorized modification to the instrument. Return the instrument to an MKS Calibration and Service Center for service and repair to ensure that all safety features are maintained.

SERVICE BY QUALIFIED PERSONNEL ONLY

Operating personnel must not remove instrument covers. Component replacement and internal adjustments must be made by qualified service personnel only.

KEEP AWAY FROM LIVE CIRCUITS

Do not replace components with power cable connected. Under certain conditions, dangerous voltages may exist even with the power cable removed. To avoid injuries, always disconnect power and discharge circuits before touching them.

USE CAUTION WHEN OPERATING WITH HAZARDOUS MATERIALS

If hazardous materials are used, users must take responsibility to observe the proper safety precautions, completely purge the instrument when necessary, and ensure that the material used is compatible with sealing materials.

PURGE THE INSTRUMENT

After installing the unit, or before its removal from a system, be sure to purge the unit completely with a clean dry gas to eliminate all traces of the previously used flow material.

USE PROPER PROCEDURES WHEN PURGING

This instrument must be purged under a ventilation hood, and gloves must be worn to protect personnel. To purge this instrument properly, it must be purged in both the horizontal base down and horizontal base up configurations as defined in SEM spec. Device has trapped volume in pressure sensor where gas which is higher than air but still hazardous can accumulate.

DO NOT OPERATE IN AN EXPLOSIVE ENVIRONMENT

To avoid explosion, do not operate this product in an explosive environment unless it has been specifically certified for such operation.

USE PROPER FITTINGS AND TIGHTENING PROCEDURES

All instrument fittings must be consistent with instrument specifications, and compatible with the intended use of the instrument. Assemble and tighten fittings according to manufacturer's directions.

CHECK FOR LEAK-TIGHT FITTINGS

Before proceeding to instrument setup, carefully check all plumbing connections to the instrument to ensure leak-tight installation.

OPERATE AT SAFE INLET PRESSURES

This unit should never be operated at pressures higher than the rated maximum pressure (refer to the product specifications for the maximum allowable pressure).

INSTALL A SUITABLE BURST DISC

When operating from a pressurized gas source, a suitable burst disc should be installed in the vacuum system to prevent system explosion should the system pressure rise.

KEEP THE UNIT FREE OF CONTAMINANTS

Do not allow contaminants of any kind to enter the unit before or during use. Contamination such as dust, dirt, lint, glass chips, and metal chips may permanently damage the unit.

ALLOW PROPER WARM UP TIME FOR TEMPERATURE-CONTROLLED UNITS

Temperature-controlled unit will only meet specifications when sufficient time is allowed for the unit to meet, and stabilize at, the designed operating temperature. Do not zero or calibrate the unit until the warm up is complete.

Sicherheitshinweise für das Massenflussgerät

In dieser Betriebsanleitung vorkommende Symbole

Bedeutung der mit WARNUNG!, VORSICHT! und HINWEIS gekennzeichneten Absätze in dieser Betriebsanleitung.



Warnung!

Das Symbol **WARNUNG!** weist auf eine Gefahr für das Bedienpersonal hin. Es macht auf einen Arbeitsablauf, eine Arbeitsweise, einen Zustand oder eine sonstige Gegebenheit aufmerksam, deren unsachgemäße Ausführung bzw. ungenügende Berücksichtigung zu Verletzungen führen kann.



Vorsicht!

Das Symbol **VORSICHT!** weist auf eine Gefahr für das Gerät hin. Es macht auf einen Bedienungsablauf, eine Arbeitsweise oder eine sonstige Gegebenheit aufmerksam, deren unsachgemäße Ausführung bzw. ungenügende Berücksichtigung zu einer Beschädigung oder Zerstörung des Gerätes oder von Teilen des Gerätes führen kann.

















Hinweis

Das Symbol **HINWEIS** macht auf wichtige Informationen bezüglich eines Arbeitsablaufs, einer Arbeitsweise, eines Zustands oder einer sonstige Gegebenheit aufmerksam.

Erklärung der am Gerät angebrachten Symbole

Nachstehender Tabelle sind die Bedeutungen der Symbole zu entnehmen, die am Gerät angebracht sein können.

Tabelle 2: Bedeutung der am Gerät angebrachten Symbole

 Ein (Energie) IEC 417, No.5007	 Aus (Energie) IEC 417, No.5008	 Erdanschluss IEC 417, No.5017	 Schutzleiteranschluss IEC 417, No.5019
 Masseanschluss IEC 417, No.5020	 Aquipotentialanschluss IEC 417, No.5021	 Gleichstrom IEC 417, No.5031	 Wechselstrom IEC 417, No.5032
 Gleich- oder Wechselstrom IEC 417, No.5033-a	 Durchgängige doppelte oder verstärkte Isolierung IEC 417, No.5172-a	 Dreileiter-Wechselstrom (Drehstrom) IEC 617-2, No.020206	
 Warnung vor einer Gefahrenstelle (Achtung, Dokumentation beachten) ISO 3864, No.B.3.1	 Warnung vor gefährlicher elektrischer Spannung ISO 3864, No.B.3.6	 Höhere Temperatur an leicht zugänglichen Teilen IEC 417, No.5041	

Sicherheitsvorschriften und Vorsichtsmaßnahmen

Folgende allgemeine Sicherheitsvorschriften sind während allen Betriebsphasen dieses Gerätes zu befolgen. Eine Missachtung der Sicherheitsvorschriften und sonstiger Warnhinweise in dieser

Betriebsanleitung verletzt die für dieses Gerät und seine Bedienung geltenden Sicherheitsstandards, und kann die Schutzvorrichtungen an diesem Gerät wirkungslos machen. MKS Instruments, Inc. haftet nicht für Missachtung dieser Sicherheitsvorschriften seitens des Kunden.

Niemals Teile austauschen oder Änderungen am Gerät vornehmen!

Ersetzen Sie keine Teile mit baugleichen oder ähnlichen Teilen, und nehmen Sie keine eigenmächtigen Änderungen am Gerät vor. Schicken Sie das Gerät zwecks Wartung und Reparatur an den MKS-Kalibrierungs- und -Kundendienst ein. Nur so wird sichergestellt, dass alle Schutzvorrichtungen voll funktionsfähig bleiben.

Wartung nur durch qualifizierte Fachleute!

Das Auswechseln von Komponenten und das Vornehmen von internen Einstellungen darf nur von qualifizierten Fachleuten durchgeführt werden, niemals vom Bedienpersonal.

Vorsicht vor stromführenden Leitungen!

Ersetzen Sie keine Komponente von Geräten, die an Netzstrom angeschlossen sind. Unter Umständen kann gefährliche Spannung auch dann bestehen, wenn das Netzanschlusskabel von der Stromversorgung entfernt wurde. Um Verletzungen vorzubeugen sollten zuerst alle Geräte von der Stromversorgung getrennt und alle Stromkreisläufe entladen werden.

Vorsicht beim Arbeiten mit gefährlichen Stoffen!

Wenn gefährliche Stoffe verwendet werden, muss der Bediener die entsprechenden Sicherheitsvorschriften genauestens einhalten, das Gerät, falls erforderlich, vollständig spülen, sowie sicherstellen, dass der Gefahrstoff die am Gerät verwendeten Materialien, insbesondere Dichtungen, nicht angreift.

Spülen des Gerätes mit Gas!

Nach dem Installieren oder vor dem Ausbau aus einem System muss das Gerät unter Einsatz eines reinen Trockengases vollständig gespült werden, um alle Rückstände des Vorgängermediums zu entfernen.

Anweisungen zum Spülen des Gerätes

Das Gerät darf nur unter einer Ablufthaube gespült werden. Schutzhandschuhe sind zu tragen.

Gerät nicht zusammen mit explosiven Stoffen, Gasen oder Dämpfen benutzen!

Um der Gefahr einer Explosion vorzubeugen, darf dieses Gerät niemals zusammen mit (oder in der Nähe von) explosiven Stoffen aller Art eingesetzt werden, sofern es nicht ausdrücklich für diesen Zweck zugelassen ist.

Anweisungen zum Installieren der Armaturen!

Alle Anschlussstücke und Armaturenteile müssen mit der Gerätespezifikation übereinstimmen, und mit dem geplanten Einsatz des Gerätes kompatibel sein. Der Einbau, insbesondere das Anziehen und Abdichten, muss gemäß den Anweisungen des Herstellers vorgenommen werden.

Verbindungen auf Undichtigkeiten prüfen!

Überprüfen Sie sorgfältig alle Verbindungen der Vakuumkomponenten auf undichte Stellen.

Gerät nur unter zulässigen Anschlussdrücken betreiben!

Betreiben Sie das Gerät niemals unter Drücken, die den maximal zulässigen Druck (siehe Produktspezifikationen) übersteigen.

Geeignete Berstscheibe installieren!

Wenn mit einer unter Druck stehenden Gasquelle gearbeitet wird, sollte eine geeignete Berstscheibe in das Vakuumsystem installiert werden, um eine Explosionsgefahr aufgrund von steigendem Systemdruck zu vermeiden.

Verunreinigungen im Gerät vermeiden!

Stellen Sie sicher, dass Verunreinigungen jeglicher Art weder vor dem Einsatz noch während des Betriebs in das Instrumenteninnere gelangen können. Staub- und Schmutzpartikel, Glassplitter oder Metallspäne können das Gerät dauerhaft beschädigen oder Prozess- und Messwerte verfälschen.

Bei Geräten mit Temperaturkontrolle korrekte Anwärmzeit einhalten!

Temperaturkontrollierte Geräte arbeiten nur dann gemäß ihrer Spezifikation, wenn genügend Zeit zum Erreichen und Stabilisieren der Betriebstemperatur eingeräumt wird. Kalibrierungen und Nulleinstellungen sollten daher nur nach Abschluss des Anwärmvorgangs durchgeführt werden.

Informations de sécurité pour appareils de mesure/contrôle de débit massique

Symboles utilisés dans ce manuel d'utilisation

Définitions des indications AVERTISSEMENT, ATTENTION, et REMARQUE utilisées dans ce manuel.



Avertissement

L'indication **AVERTISSEMENT** signale un danger pour le personnel. Elle attire l'attention sur une procédure, une pratique, une condition, ou toute autre situation présentant un risque d'accident pour le personnel, en cas d'exécution incorrecte ou de non-respect des consignes.



Attention

L'indication **ATTENTION** signale un danger pour l'appareil. Elle attire l'attention sur une procédure d'exploitation, une pratique, ou toute autre situation, présentant un risque de dégât ou de destruction partielle ou totale du produit, en cas d'exécution incorrecte ou de non-respect des consignes.

















Remarque

L'indication **REMARQUE** signale une information importante. Elle attire l'attention sur une procédure, une pratique, une condition, ou toute autre situation, présentant un intérêt particulier.

Symboles figurant sur l'unité

Le tableau suivant décrit les symboles pouvant apparaître sur l'unité.

Tableau 3: Définition des symboles sur l'unité

 Marche (sous tension) IEC 417, No.5007	 Arrêt (hors tension) IEC 417, No.5008	 Terre (masse) IEC 417, No.5017	 Terre de protection (masse) IEC 417, No.5019
 Masse IEC 417, No.5020	 Equipotentialité IEC 417, No.5021	 Courant continu IEC 417, No.5031	 Courant alternatif IEC 417, No.5032
 Courant continu et alternatif IEC 417, No.5033-a	 Matériel de classe II IEC 417, No.5172-a	 Courant alternatif triphasé IEC 617-2, No.020206	
 Attention : se reporter à la documentation ISO 3864, No.B.3.1	 Attention : risque de choc électrique ISO 3864, No.B.3.6	 Attention : surface brûlante IEC 417, No.5041	

Mesures de sécurité et précautions

Observer les précautions générales de sécurité suivantes pendant toutes les phases d'exploitation de cet appareil. Le non-respect des ces précautions ou des avertissements du manuel constitue une violation des normes de sécurité relatives à l'utilisation de l'appareil et peut compromettre la protection assurée

par l'appareil. MKS Instruments, Inc. rejette toute responsabilité en cas de non-respect des consignes par les clients.

PAS DE REMPLACEMENT DE PIÈCES OU DE MODIFICATION DE L'APPAREIL

Ne pas installer de pièces de remplacement ni effectuer des modifications non autorisées sur l'appareil. Renvoyer l'appareil à un centre de service et de calibrage MKS pour tout dépannage ou réparation afin de garantir le l'intégrité des dispositifs de sécurité.

DÉPANNAGE UNIQUEMENT PAR DU PERSONNEL QUALIFIÉ

Le personnel d'exploitation ne doit pas essayer de sortir les composants du boîtier ou faire des réglages internes. Le dépannage est réservé au personnel qualifié.

ÉLOIGNEMENT DES CIRCUITS SOUS-TENSION

Ne pas remplacer de composants lorsqu'un câble d'alimentation est branché. Dans certaines conditions, des tensions dangereuses peuvent être présentes même après le retrait du câble d'alimentation. Pour éliminer tout risque de blessure, procéder toujours à la déconnexion et décharger les circuits avant tout contact physique.

PRÉCAUTION EN CAS D'UTILISATION AVEC DES PRODUITS DANGEREUX

Si des produits dangereux sont utilisés, l'utilisateur est responsable du respect des mesures de sécurité appropriées, de la purge complète de l'appareil quand elle s'avère nécessaire, et doit s'assurer que les produits utilisés sont compatibles avec les matériaux d'étanchéité.

PURGE DE L'APPAREIL

Après l'installation de l'unité, ou avant son retrait d'un système, purger l'unité complètement avec un gaz propre et sec afin d'éliminer toute trace du produit de flux utilisé précédemment.

UTILISATION DES PROCÉDURES APPROPRIÉES POUR LA PURGE

Cet appareil doit être purgé sous une hotte de ventilation. Le personnel doit porter des gants de protection.

PAS D'EXPLOITATION DANS UN ENVIRONNEMENT EXPLOSIF

Pour éviter toute explosion, ne pas utiliser cet appareil dans un environnement explosif, sauf en cas d'homologation spécifique pour une telle exploitation.

UTILISATION D'ÉQUIPEMENTS ET PROCÉDURES DE SERRAGE APPROPRIÉS

Tous les équipements de l'appareil doivent être conformes à ses spécifications, et compatibles avec l'utilisation prévue de l'appareil. Assembler et serrer les équipements conformément aux directives du fabricant.

VÉRIFICATION DE L'ÉTANCHÉITÉ DES CONNEXIONS

Vérifier attentivement toutes les connexions des composants pour le vide afin de garantir l'étanchéité de l'installation.

EXPLOITATION AVEC DES PRESSIONS D'ENTRÉE NON DANGEREUSES

Ne jamais utiliser des pressions supérieures à la pression nominale maximum (se reporter aux spécifications de l'unité pour la pression maximum admissible).

INSTALLATION D'UN DISQUE D'ÉCHAPPEMENT ADAPTÉ

En cas d'exploitation avec une source de gaz pressurisé, installer un disque d'échappement adapté dans le système à vide, afin d'éviter une explosion du système en cas d'augmentation de la pression.

MAINTIEN DE L'UNITÉ À L'ABRI DES CONTAMINATIONS

Ne pas laisser des produits contaminants pénétrer dans l'unité avant ou pendant l'utilisation. Des produits contaminants tels que des poussières et des fragments de tissu, de verre et de métal peuvent endommager l'unité de manière permanente.

RESPECT DU TEMPS D'ÉCHAUFFEMENT APPROPRIÉ POUR LES UNITÉS À RÉGULATION DE TEMPÉRATURE

Les unités à régulation de température sont conformes à leurs spécifications uniquement quand on leur laisse un temps suffisant pour atteindre d'une manière stable la température d'exploitation. Ne pas remettre à zéro ou calibrer l'unité tant que l'échauffement n'est pas terminé.

Medidas de seguridad del dispositivo de flujo de masa

Símbolos usados en este manual de instrucciones

Definiciones de los mensajes de advertencia, precaución y de las notas usados en el manual.



Advertencia

El símbolo de advertencia indica la posibilidad de que se produzcan daños personales. Pone de relieve un procedimiento, práctica, estado, etc. que en caso de no realizarse o cumplirse correctamente puede causar daños personales.



Precaución

El símbolo de precaución indica la posibilidad de producir daños al equipo. Pone de relieve un procedimiento operativo, práctica, etc. que en caso de no realizarse o cumplirse correctamente puede causar daños o la destrucción total o parcial del equipo.



Nota

El símbolo de notas indica información de importancia. Este símbolo pone de relieve un procedimiento, práctica o condición cuyo conocimiento es esencial destacar.

Símbolos hallados en la unidad

La tabla siguiente contiene los símbolos que puede hallar en la unidad.

Tabla 4: Definición de los símbolos hallados en la unidad

 Encendido (alimentación eléctrica) IEC 417, N° 5007	○ Apagado (alimentación eléctrica) IEC 417, N° 5008	⏏ Puesta a tierra IEC 417, N° 5017	⏏ Protección a tierra IEC 417, N° 5019
⏏ Caja o chasis IEC 417, N° 5020	⏏ Equipotencialidad IEC 417, N° 5021	≡ Corriente continua IEC 417, N° 5031	~ Corriente alterna IEC 417, N° 5032
~ Corriente continua y alterna IEC 417, N° 5033-a	□ Equipo de clase II IEC 417, N° 5172-a	3~ Corriente alterna trifásica IEC 617-2, N° 020206	
⚠ Precaución. Consulte los documentos adjuntos ISO 3864, N° B.3.1	⚡ Precaución. Riesgo de descarga eléctrica ISO 3864, N° B.3.6	🔥 Precaución. Superficie caliente IEC 417, N° 5041	

Procedimientos y precauciones de seguridad

Las medidas generales de seguridad descritas a continuación deben observarse durante todas las etapas de funcionamiento del instrumento. La fMFC de cumplimiento de dichas medidas de seguridad o de las advertencias específicas a las que se hace referencia en otras partes de este manual, constituye una violación de las normas de seguridad establecidas para el uso previsto del instrumento y podría anular

la protección proporcionada por el equipo. Si el cliente no cumple dichas precauciones y advertencias, MKS Instruments, Inc. no asume responsabilidad legal alguna.

NO UTILICE PIEZAS NO ORIGINALES O MODIFIQUE EL INSTRUMENTO

No instale piezas que no sean originales ni modifique el instrumento sin autorización. Para asegurar el correcto funcionamiento de todos los dispositivos de seguridad, envíe el instrumento al Centro de servicio y calibración de MKS toda vez que sea necesario repararlo o efectuar tareas de mantenimiento.

LAS REPARACIONES DEBEN SER EFECTUADAS ÚNICAMENTE POR TÉCNICOS AUTORIZADOS

Los operarios no deben retirar las tapas del instrumento. El reemplazo de los componentes y las tareas de ajuste deben ser realizadas únicamente por personal autorizado.

MANTÉNGASE ALEJADO DE LOS CIRCUITOS ACTIVOS

No reemplace componentes con el cable de alimentación eléctrica conectado. En algunos casos, puede haber presente alto voltaje aun con el cable de alimentación eléctrica desconectado. Para evitar lesiones personales, desconecte siempre el cable y descargue los circuitos antes de entrar en contacto con los mismos.

TENGA CUIDADO CUANDO TRABAJE CON MATERIALES TÓXICOS

Cuando se utilicen materiales tóxicos, es responsabilidad de los operarios tomar las medidas de seguridad correspondientes, purgar totalmente el instrumento cuando sea necesario y comprobar que el material utilizado sea compatible con los materiales de sellado.

PURGUE EL INSTRUMENTO

Una vez instalada la unidad o antes de retirarla del sistema, purgue completamente la unidad con gas limpio y seco para eliminar todo resto de la sustancia líquida empleada anteriormente.

USE PROCEDIMIENTOS ADECUADOS PARA REALIZAR LA PURGA

El instrumento debe purgarse debajo de una campana de ventilación y deben utilizarse guantes protectores.

NO HAGA FUNCIONAR EL INSTRUMENTO EN AMBIENTES CON RIESGO DE EXPLOSIÓN

Para evitar que se produzcan explosiones, no haga funcionar este instrumento en un ambiente con riesgo de explosiones, excepto cuando el mismo haya sido certificado específicamente para tal uso.

USE ACCESORIOS ADECUADOS Y REALICE CORRECTAMENTE LOS PROCEDIMIENTOS DE AJUSTE

Todos los accesorios del instrumento deben cumplir las especificaciones del mismo y ser compatibles con el uso que se debe dar al instrumento. Arme y ajuste los accesorios de acuerdo con las instrucciones del fabricante.

COMPRUEBE QUE LOS ACCESORIOS SEAN A PRUEBA DE FUGAS

Antes de proceder con la instalación del instrumento, inspeccione cuidadosamente todas las conexiones de las tuberías para comprobar que hayan sido instaladas a prueba de fugas.

HAGA FUNCIONAR EL INSTRUMENTO CON PRESIONES DE ENTRADA SEGURAS

No haga funcionar nunca el instrumento con presiones superiores a la máxima presión nominal (en las especificaciones del instrumento hallará la presión máxima permitida).

INSTALE UNA CÁPSULA DE SEGURIDAD ADECUADA

Cuando el instrumento funcione con una fuente de gas presurizado, instale una cápsula de seguridad adecuada en el sistema de vacío para evitar que se produzcan explosiones cuando suba la presión del sistema.

MANTENGA LA UNIDAD LIBRE DE CONTAMINANTES

No permita el ingreso de contaminantes en la unidad antes o durante su uso. Los productos contaminantes tales como polvo, suciedad, pelusa, lascas de vidrio o virutas de metal pueden dañar irreparablemente la unidad.

CALIENTE ADECUADAMENTE LAS UNIDADES CONTROLADAS POR MEDIO DE TEMPERATURA

Las unidades controladas por medio de temperatura funcionarán de acuerdo con las especificaciones sólo cuando se las caliente durante el tiempo suficiente para permitir que lleguen y se estabilicen a la temperatura de operación indicada. No calibre la unidad y no la ponga en cero hasta que finalice el procedimiento de calentamiento.

マスフロー機器の安全に関する情報

本取扱説明書のマーク

本マニュアルでは警告、注意、ポイントのマークを用いて重要な事項を記載しています。



警告

この表示を無視して誤った取り扱い(手順や使用方法、条件など)をすると、人が重傷を負う可能性が想定される内容を示しています。必ずお読みください。



注意

この表示を無視して誤った取り扱い(手順や使用方法など)をすると、製品が損傷する可能性が想定される内容を示しています。必ずお読みください。



ポイント

この表示は手順や使用方法、条件などに関する重要な情報が記載されていることを示しています。必ずお読みください。

本機器のマーク

以下の表では、本機器に使用されているマークについて説明いたします。

表 5: 本機器に使用されているマークについて

 オン(電源) IEC 417, No. 5007	 オフ(電源) IEC 417, No. 5008	 接地(アース) IEC 417, No. 5017	 保護接地(アース) IEC 417, No. 5019
 フレームまたはシャーシ IEC 417, No. 5020	 等電位 IEC 417, No. 5021	 直流 IEC 417, No. 5031	 交流 IEC 417, No. 5032
 直流と交流 IEC 417, No. 5033-a	 クラス2 機器 IEC 417, No. 5172-a	 三相交流 IEC 617-2, No. 020206	
 注意(付属書を参照) ISO 3864, No. B.3.1	 注意(感電の危険あり) ISO 3864, No. B.3.6	 注意(表面が熱くなっています) IEC 417, No. 5041	

安全対策について

本機器を使用する際は、必ず以下の安全対策を守ってください。これらの安全対策や本マニュアルの警告を無視すると、機器本来の用途の安全基準を侵害することになり、機器が提供する保護機能が損なわれる可能性があります。MKS Instruments, Inc. は、顧客側の安全対策の不履行に対しては一切責任を負いかねます。

勝手に部品を変えたり、本体を改造しないこと

本機器に代用部品を使用したり、不正な改造を加えないでください。すべての安全システムを正しく機能させるための修理やメンテナンスが必要な場合は、本機器を MKS Calibration and Service Center まで戻してください。

修理は必ず専門の修理サービスを利用すること

オペレータは絶対に本機器を分解しないでください。部品の交換や内部の調整は必ず専門の修理サービスを利用してください。

電流が通じている回路から切断すること

電源ケーブルを接続したままで部品を交換しないでください。特定の状況では、電源ケーブルを取り外した状態でも危険な電圧が残っている場合があります。感電などの事故を防ぐため、回路に触れる前に必ず電源から切断し、放電してください。

危険な材料を使用する場合は慎重に機器を使用すること

危険な材料を使用する場合は、使用者は各自の責任の元で適切な安全対策を講じてください。必要に応じて本機器を浄化してください。また、使用する材料に対するシーリング材の耐久性を確認してください。

機器を浄化すること

本機器を取り付けた後やシステムから取り外す前に、きれいな乾燥ガスで本機器を浄化し、使用した材料を完全に取り除いてください。

浄化する場合は適切な手順で行うこと

本機器の浄化は換気フードの下で行う必要があります。また、浄化作業を行う人は必ず手袋を着用してください。

爆発の危険性のある環境で機器を使用しないこと

爆発が起きるのを防ぐため、本機器を爆発の危険性のある環境で使用しないでください。ただし、そのような環境での使用が特別に保証されている場合は除きます。

適切な金具類を使用し、手順に従って金具の締めを行うこと

金具類は本機器の仕様と一致し、機器本来の用途に適合したものである必要があります。金具類の取り付けや締めは、製造業者の指示に従ってください。

液体の漏れがないよう接続箇所を確認すること

本機器を設定する前に、すべての配管の接続を慎重に確認し、液体が漏れないようにしてください。

安全なインレット圧力で使用すること

定格の最大圧力を超える圧力の下で本機器を絶対に使用しないでください(最大許容圧力については仕様書を参照)。

適切なバーストディスクを取り付けること

圧力のかかったガスを使用する場合は、万一システムが爆発した場合にシステムの圧力が上昇するのを防ぐため、真空システムに適切なバーストディスクを取り付けてください。

本機器に異物やゴミが混入しないようにすること

本機器の使用前または使用中に、ほこりやゴミ、繊維、ガラスの破片、金属片などの異物やゴミが混入しないようにしてください。本機器が損傷する可能性があります。

温度調整された機器を十分に温めてから使用すること

温度調整された機器が適切な作動温度にならないうちに使用すると、仕様通りの動作をしないことがあります。本機器が十分に温まるまでは目盛りをゼロに合わせたり、較正しないでください。

질량 유량 장치 안전 정보

본 지침 매뉴얼에 사용되는 기호들

매뉴얼 전체에 사용되는 경고, 주의 및 참고 메시지의 정의.



경고

경고 표시는 위험을 나타냅니다. 이 표시는 올바르게 수행되거나 지켜지지 않을 경우, 사람에게 상해를 입힐 수 있는 절차, 수행지침, 상태 또는 이와 유사한 상황들에 대한 주의를 환기시킵니다.



주의

주의 표시는 위험을 나타냅니다. 이 표시는 올바르게 수행되거나 지켜지지 않을 경우, 제품의 일부나 전체에 손상이나 파손을 일으킬 수 있는 절차, 수행지침 또는 이와 유사한 상황들에 대한 주의를 환기시킵니다.



참고

참고 표시는 중요한 정보를 나타냅니다. 이 표시는 강조할 만한 주요 절차, 수행지침, 상태 또는 이와 유사한 상황들에 대한 주의를 환기시킵니다.

장치에 표시된 기호들

다음 표는 장치에서 볼 수 있는 기호들을 설명합니다.

표 6: 장치에 표시된 기호들의 정의

 컴 (전원) IEC 417, No. 5007	○ 꿈 (전원) IEC 417, No. 5008	⏏ 접지(지면) IEC 417, No. 5017	⏏ 보호 접지(지면) IEC 417, No. 5019
⏏ 프레임 또는 새시 IEC 417, No. 5020	⚡ 등전위성 IEC 417, No. 5021	≡ 직류 IEC 417, No. 5031	~ 교류 IEC 417, No. 5032
~ 직류와 교류 모두 IEC 417, No. 5033-a	□ 클래스 II 장비 IEC 417, No. 5172-a	3~ 3상 교류 IEC 617-2, No. 020206	
⚠ 주의 (동봉 문서 참조) ISO 3864, No. B.3.1	⚡ 주의, 감전 위험 ISO 3864, No. B.3.6	⚠ 주의, 표면이 뜨거움 IEC 417, No. 5041	

안전 절차 및 예방조치

본 기계의 모든 작동 시에 다음의 일반 안전 예방조치를 준수하십시오. 아래 예방조치를 준수하지 않거나 본 매뉴얼의 다른 부분에 있는 특정 경고를 준수하지 않을 경우, 기계 사용 목적의 안전 기준을 위반하는 것이 되며, 장비가 제공하는 보호기능을 손상시킬 수 있습니다. MKS Instruments, Inc.는 고객이 본 요건을 준수하지 않는 경우에 대해서는 어떠한 책임도 지지 않습니다.

부품을 교체하거나 기계를 개조하지 마십시오

교체 부품을 설치하거나 기계에 허가되지 않은 어떠한 수정도 가하지 마십시오. 서비스와 수리가 필요한 경우에는 모든 안전 특성이 유지되도록 기계를 MKS 보정 서비스 센터(MKS Calibration and Service Center)로 보내주십시오.

자격이 있는 사람에게만 서비스를 받으십시오

작동하는 사람은 기계 걸면을 제거해서는 안됩니다. 부품 교체 및 내부 조정은 자격이 있는 서비스 기사에게만 받으실 수 있습니다.

전류가 통하는 회로에서 분리해 보관하십시오

전원 케이블을 연결한 채로 부품을 교체하지 마십시오. 일부 환경에서는 전원 케이블을 제거한 상태라도 위험 전압이 존재할 수 있습니다. 부상을 방지하려면, 전원을 항상 분리하고 회로를 만지기 전에 회로를 방전시키십시오.

위험한 물질과 함께 작동할 때는 주의를 기울이십시오

위험한 물질이 사용되는 경우, 사용자는 필요시 기계를 완전히 청소하여, 적절한 안전 예방조치를 준수할 책임을 지키고, 사용된 물질이 봉인 물질과 함께 사용해도 무방하다고 보증할 수 있어야 합니다.

기계를 청소하십시오

장치를 설치한 후나 시스템에서 장치를 제거하기 전에는 반드시 깨끗한 건조성 기체로 장치를 완전히 청소하여 이전에 사용된 유량 물질의 모든 흔적을 제거하십시오.

청소 시에는 적절한 절차를 사용하십시오

본 기계는 환기 후드 아래에서 청소되어야 하며, 인체 보호를 위해 장갑을 착용해야 합니다.

폭발성 환경에서 작동하지 마십시오

폭발을 방지하려면, 폭발성 환경에서 작동하도록 특별히 승인받지 않은 경우 본 제품을 폭발성 환경에서 작동하지 마십시오.

적절한 조립부품과 조립 절차를 사용하십시오

모든 기계 조립부품은 제품 사양과 일치해야 하고, 기계의 사용 목적에 부합해야 합니다. 제조업체의 지시에 따라 조립부품을 조립하고 조이십시오.

누출방지 조립부품을 점검하십시오

기계 설치를 진행하기 전에 기계의 모든 연관 연결부를 점검해 누출방지 설치가 되었는지 확인하십시오.

안전한 흡입 압력에서 작동하십시오

이 장치는 절대 정격 최대 압력보다 높은 압력에서 작동해서는 안됩니다(최대 허용 압력에 대해서는 제품 사양을 참조하십시오).

적합한 안전 파열판을 설치하십시오

가압 가스 공급원에서 작동시, 시스템 폭발이 시스템 압력 상승을 일으키는 것을 방지하기 위해 적합한 안전 파열판이 진공 시스템에 설치되어야 합니다.

장치를 오염이 없는 곳에 보관하십시오

장치를 사용하기 전이나 사용 중에는 어떠한 종류의 오염 물질도 허용해서는 안됩니다. 먼지, 때, 보풀, 유리 조각, 금속 조각과 같은 오염 물질은 영구적으로 장치를 손상시킬 수 있습니다.

온도 제어 장치의 경우 알맞은 시동 시간을 두십시오

온도 제어 장치는 장치가 설계 작동 온도와 일치하고 이 온도에서 안정화될 수 있도록 충분한 시간을 허용해야만 사양에 맞게 작동합니다. 시동이 완료될 때까지 장치를 영점 설정하거나 보정하지 마십시오.

Chapter One: General Information

Introduction

MKS Instruments P3B and P4B MFCs represent state-of-the-art technology meeting the advanced process requirements of next generation toolsets. These devices integrate thermal sensor technology together with a MKS real-time feedback control system providing typical flow control response times of about 750 milliseconds with either a normally closed or normally open valve.

The P4B MFC includes an integrated multifunctional local display and an embedded, web-based user interface. The device is available with full scale flow ranges of 5 sccm to 50 slm (N₂ equivalent) in standard 1.125" C-seal, W-seal surface mount, 1.5" W-seal surface mount or ¼" VCR™ form factors. Both digital and analog I/O are available and selectable as an option.

The P3B MFC includes an embedded, web-based user interface. The device is available with full scale flow ranges of 5 sccm to 50 slm (N₂ equivalent) in a compact, 106 mm face-to-face ¼" VCR™ form factor. DeviceNet is the currently available I/O for the device.

Design Features

Increases Throughput and Performance

- ◆ Accurate flow control for both the calibration and the user selected gas.
- ◆ Enables better chamber matching through increased MFC accuracy of any process gas.
- ◆ Increases tool uptime through reduction of “No Problem Found” MFC replacements.
- ◆ Includes embedded diagnostics software that allows users to check MFC functionality without removing the MFC.
- ◆ E-diagnostics through embedded Ethernet interface.

Reduce Overall Costs

- ◆ Reduces MFC inventory through multi-gas, multi-range availability.
- ◆ Minimizes overall footprint of gas delivery module.

Easy to Integrate and Operate

- ◆ Straightforward configuration and diagnostics through Ethernet user interface which:
 - Uses standard web browser (e.g. IE8 or Firefox) – no special software required.
 - Includes remote PC application.
- ◆ Easy viewing of flow rate, gas type, full scale and Ethernet address via its LED display (P4B only).

The design of these MFCs incorporates an advanced flow sensor, a control valve, and an optimized bypass. The latest generation two-element sensing circuit provides accurate, repeatable performance even in low flow ranges (< 10 sccm). A low temperature effect from ambient temperature change and minimal attitude sensitivity effect are also ensured. Attitude sensitivity is completely accounted for with advanced attitude circuitry. The optimized sensor/bypass arrangement minimizes the flow splitting error for gases with different properties, which dramatically improves measurement accuracy when gases other than the calibration gas are used.

Control (I/O) Interfaces

These P3B and P4B MFCs are available with either analog (P4B only) or digital interface I/O which is specified by the user at time of ordering.

Analog I/O is available via either a 9-pin D or 15-pin D. The 9-pin D option provides for setpoint I/O along with a valve override function. The 15-pin D option provides for setpoint I/O, valve override and the ability to control to an optional input. Analog I/O is covered in detail in this manual.

The digital control I/O may be via RS485 (P4B only), DeviceNet or a modified Modbus protocol. An overview of each along with connector, power supply and switch information is included in this manual. Protocol specifics (profile) are included in separate documentation.

Reliability

To provide excellent reliability, the design contains a low mechanical and electronic components count and has successfully passed the following tests:

STRIFE, including temperature cycling and vibration (sine and random tests)

EMC Directive 2004/108/EC for CE Mark compliance (with a metal braided, shielded cable, properly grounded at both ends)

ODVA Compliance (DeviceNet version)

Cleanliness Features

The P4B and P3B use only metal for all external seals. The metal seals eliminate gas permeation and ensure extremely low external leakage under pressure or vacuum conditions relative to atmosphere. The internal valve control plug is Teflon which is chemically stable and not prone to out-gassing or particle generation. The MFC's mechanical design incorporates minimal wetted surface area and virtual leaks, assuring rapid dry-down. To further enhance its cleanliness, internal surfaces are precision machined to a 10Ra surface finish that is electropolished. The instrument is assembled and double-packaged in a Class 100 clean room environment.

How This Manual is Organized

Before installing the device in a system and/or operating it, carefully read and familiarize yourself with all precautionary notes in the *Mass Flow Device Safety Information* section at the front of this manual. In addition, observe and obey all WARNING and CAUTION notes provided throughout the manual.

Chapter One: General Information introduces the product and describes the organization of the manual.

Chapter Two: Overview provides an overview on the use of Mass Flow Control

Chapter Three: Installation and Configuration provides outline drawings and information on the product installation

Chapter Four: Analog and Digital Interface: Provides information on each of the available I/O interfaces.

Chapter Five: Ethernet Interface Setup and Configuration

Chapter Six: Embedded Web-Based GUI and Diagnostics

Chapter Seven: Maintenance: Lists maintenance required to keep the instrument in good working condition.

Chapter Eight: Troubleshooting provides a reference should the instrument appears to malfunction.

Appendix A: Product Specifications lists the specifications of the instrument.

Appendix B : Model Code Explanation describes the model code.

Customer Support

Standard maintenance and repair services are available through all of the regional MKS Calibration and Service Centers.

If any difficulties arise in the use of your device, or to obtain information about companion products MKS offers, contact any authorized MKS Calibration and Service Center. If it is necessary to return the instrument to MKS, then two actions must be completed before shipping: (1) a RMA (Return Material Authorization) number must be obtained and (2) a Health and Safety Form must be completed and included with the instrument.



Warning All returns to MKS Instruments must be free of harmful, corrosive, radioactive, or toxic materials.

Obtaining a Return Material Authorization (RMA) Number

RMA (Return Material Authorization) numbers expedite handling and ensure proper servicing of your instrument.

RMA numbers can be obtained by contacting the MKS Calibration and Service Center or through the MKS website at: <http://www.mksinst.com/service/servicehowtoorder.aspx>.



Note Returned instruments will not be accepted without a valid RMA number displayed on the shipping container.

Health and Safety Form

A returned instrument will not be examined without a signed Health and Safety form indicating that the unit is free of harmful materials.

The Health and Safety form can be obtained on the last page of this manual or through the MKS website at: <http://www.mksinst.com/service/servicehowtoorder.aspx>.



Note Returned instruments will not be examined without a signed certificate indicating the instruments are free of harmful materials.



Warning All returns to MKS Instruments must be free of harmful, corrosive, radioactive, or toxic materials and is the responsibility of the user to ensure.

Chapter Two: Overview

General Information

Typical Flow Control System Configuration

The MFC is used in a wide variety of control systems, most of which share several characteristics. The control system consists of four basic parts:

Mass flow transducer

Control electronics

Control valve

Flow system (whose flow is being controlled by the MFC.)

The MFC provides the first three components. The mass flow transducer is an MKS thermal sensor design. The MFC instrument contains the electronics necessary for flow control. The control valve included in the device is a proportional control valve. The flow system can be any process whose flow you need to control. In addition, the MFC is capable of metering the mass flow of the gas during the flow control operation.

Flow Measurement Overview

The MFC measures the mass flow rate of a gas and controls the flow rate according to a given setpoint. The accuracy from 20% to 100% of Full Scale (F.S.) is $\pm 1\%$ of Reading. For setpoints between 2% and 20%, MFC Mass Flow Devices have an accuracy of $\pm 0.2\%$ FS.

Flow Path

Upon entering the MFC, the gas stream passes first through the metering section of the instrument for its mass flow to be measured. The gas moves on through the control valve, which regulates the flow rate according to the given setpoint and in response to the device's control system, and then exits the instrument at the established rate of flow.

The metering section consists of one of the following:

A sensor tube for Full Scale ranges ≤ 10 sccm (N_2 equivalent)

A sensor tube and parallel bypass for ranges > 10 sccm (N_2 equivalent)

The geometry of the sensor tube, in conjunction with the specified full scale flow rate, ensures fully developed laminar flow in the sensing region. The bypass elements are specifically matched to the characteristics of the sensor tube to achieve a laminar flow splitting ratio which remains constant throughout each range.

Flow Control Range

The MFC can control flow over a range of 2 to 100% of full scale flow. This means that a MFC with a 1000 sccm configuration can control flow from 20 to 1000 sccm, whereas an instrument with a 100 sccm configuration can control flow from 2 to 100 sccm.

Measurement Technique

The flow measurement is based on differential heat transfer between temperature sensing heater elements which are attached to the exterior of the sensor tube. This senses the thermal mass movement which is converted to mass flow via the specific heat, C_p , of the gas.

Control Circuitry

The controller employs the above measurement technique and utilizes a control circuit that provides drive current for the proportioning control valve. The flow controller accepts a setpoint signal, compares it to its own flow signal, and generates an error voltage. This error signal is then conditioned so that it can reposition the control valve, thus reducing the control error to zero.

In the normally closed control valve, the MFC instrument lifts the armature and plug assembly from the seat to regulate the gas flow rate. In the normally open valve, full valve current is applied when there is not an active setpoint which closes the valve so long as there is power to the device.

Control Valve

The control valve is a specially constructed solenoid valve in which the armature (moving valve mechanism) is suspended. The arrangement ensures that no friction is present and makes precise control possible.

How the MFC Works

The MKS MFC includes technology improvements in functionality and performance to help users in semiconductors increase tool throughput and reduce overall system costs. Real-time accurate flow control is provided through advanced digital algorithms. Enabling real-time control of process gas flow, accuracy and repeatability are significantly improved over conventional PID based digital MFC's. For optimum control performance, the user can (should) specify the inlet pressure to the device through the Ethernet

The MFC compares the flow reading to the setpoint, and positions the valve to maintain, or achieve, the setpoint rate. The controller functions as a model based, pressure insensitive flow controller.

Example

Assume that your MFC is positioned upstream of the process chamber. The MFC is positioned *before* the chamber so it will regulate the flow rate of the gas entering the process chamber.

When the actual flow rate reading is *less than* the setpoint value, the MFC opens the valve to increase the amount of gas entering the system. As the valve opens, assuming adequate differential pressure across the flow controller, gas enters the process chamber, so the flow rate rises to meet the setpoint value.

When the actual flow rate reading is *more than* the setpoint value, the MFC closes the valve to decrease the amount of gas entering the system. As the valve closes, there is a reduced flow of gas entering the process chamber, so the flow rate decreases to meet the setpoint value.



Note

The MFC must have sufficient differential pressure from inlet to outlet to achieve the setpoint. If the device does not reach setpoint for lack of differential pressure, either increasing the inlet pressure or decreasing the outlet pressure may be necessary.



Note

For optimal control performance, the user should specify the inlet pressure provided to the MFC through the Ethernet user interface.

Operation of the MFC with Gases other than Nitrogen

The P3B and P4B MFCs are unique in MKS flow control technology in that they do not use gas correction factors as many other mass flow controllers do. The operation of the P3B or P4B MFC is based on thermodynamic principals and multi-component functions have been developed to accurately calculate the non-linear gas flow of non-calibration gases, with respect to the calibration gas. The current MKS library of gases and functions is in excess of 40 in number and includes most gases in common usage. For gases whose parameters that are not already stored on the MFC, consult MKS.

When a gas other than the calibration gas is selected by the user, the MFC automatically pulls up the correct functions that calculate the flow of that gas with respect to the original calibration. This allows the MFC to report the gas flow for the gas in use immediately and with better accuracy than has previously been available. In comparison, the typical MFC uses Gas Correction factors for converting the calibration gas flow into the flow of the gas being used. This may lead to inaccuracy in the flow reported to levels as high as 6-10% (of FS) depending on the gas used.

The P4B and P3B MFCs, by using these functions for the various gases, actually reports the flow within the stated accuracy of the flow controller, but for non-calibration gases. The reported flow from a MFC using Helium as the process gas, but not calibrated for Helium, will have the same accuracy for the Helium as it does for Nitrogen, the calibration gas. Traditional flow controllers and meters using a Gas Correction Factor for Helium typically have an error in the flow output of as much as 5% of FS or more.

Chapter Three: Installation and Configuration

Unpacking

MKS has carefully packed your device so that it will reach you in perfect operating order. Upon receiving the unit, however, you should check for defects, cracks, broken connectors, etc., to be certain that damage has not occurred during shipment.



Note Do *not* discard any packing materials until you have completed your inspection and are sure the unit arrived safely.

If you find any damage, notify your carrier and MKS immediately. If it is necessary to return the unit to MKS, obtain an RMA Number (Return Material Authorization Number) from the MKS Calibration and Service Center before shipping. Please refer to the inside of the back cover of this manual for a list of MKS Calibration and Service Centers.

Opening the Package

Each device is assembled, leak tested with helium, and calibrated in a cleanroom environment. The instrument is double-packaged in this environment to ensure maintenance of its particle free condition during shipment. It is very important to remove the packaging according to good clean room practices. To maintain at least a minimal level of clean room standards, follow the instructions below:

1. Remove all cardboard and packaging materials. Set aside before entering the garmenting room. Do not discard until the device has been inspected for damage and determined to be in working order.
2. Remove the outer plastic shipping container in an ante room (garmenting room) or transfer box. Do not allow this container to enter the clean room.
3. Remove the inner bag in the clean room.
4. Inspect for any damage.
5. Pass the original calibration sheet to the appropriate personnel at your company.



Caution Only qualified individuals should perform the installation and adjustments of the MFC. Individuals must comply with all necessary ESD handling precautions while installing and adjusting the instrument. Proper handling is essential when working with all highly sensitive precision electronic instruments.

Unpacking Checklist

Standard Equipment:

MFC

Flow calibration sheet

Product Location and Requirements

Ventilation requirements include sufficient air circulation

Ambient operating temperature range: 10° to 50° C (50° to 122° F)

Power requirement: 11-25 VDC [320 mA maximum current @ 11 VDC
146 mA @ 24 VDC nominal]

Storage temperature range: -20° to 65° C (-4° and 149° F)

Mount the MFC in an upright position if possible for easy viewing of the display (P4B only), although any mounting orientation is satisfactory.

Install a separate positive shutoff valve if your system cannot tolerate any leakage through the MFC. The internal flow control valve is not a positive shutoff valve so some leakage across the valve may occur.



Warning

Your corporate policy on handling toxic or hazardous gases supersedes the instructions in this manual. Comply with your corporate policy. MKS assumes no liability for the safe handling of such materials.

Install the MFC in a “flowing” system where gas is continually added and evacuated. Do *not* use the controller in a “dead-ended” system (a system which cannot remove excess mass). The MFC can not vent excess mass to the atmosphere.

Warm up time: 30 minutes minimum (1 hour suggested to equilibrate with ambient environment)

Use high purity gas filters in line upstream of the device.

Observe the pressure limits for the flow device.

Controller:

Maximum gas inlet pressure is 150 psig with a properly configured valve (consult factory for cases where inlet pressure is expected to exceed 40 psig).

Operationing differential pressure with atmosphere for standard valve configurations at the outlet is:

- 10 to 5000 sccm, 10 to 40 psid
- 10000 to 20000 sccm 15 to 40 psid
- 30000 to 50000 sccm 25 to 40 psid

Valve configurations for low pressure drop applications are available. Please consult MKS for these situations.

For additional information, refer to Appendix A, *Product Specifications*, page 89

Dimensions - P4B

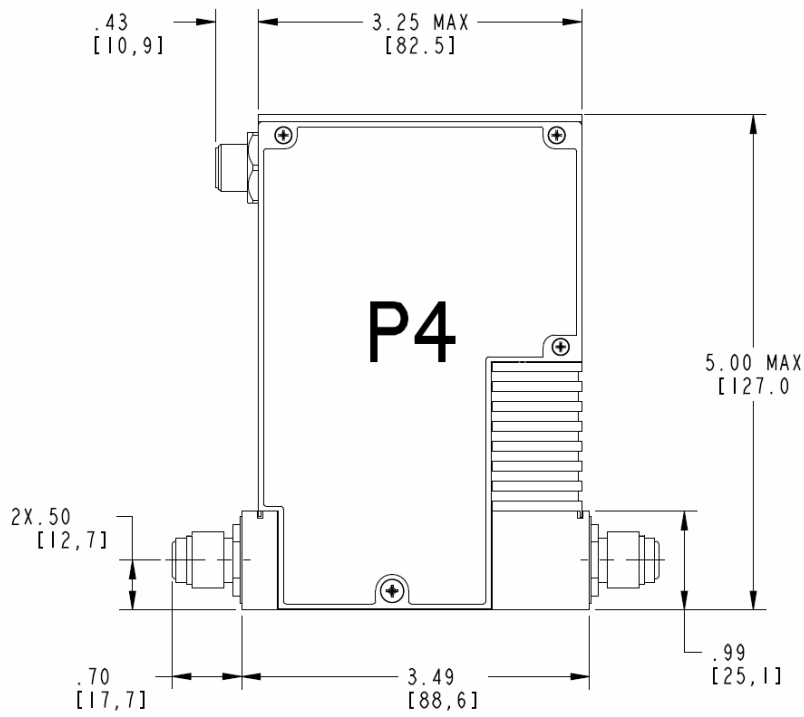

Figure 1: 4-VCR Front View - (Normally Closed Valve)

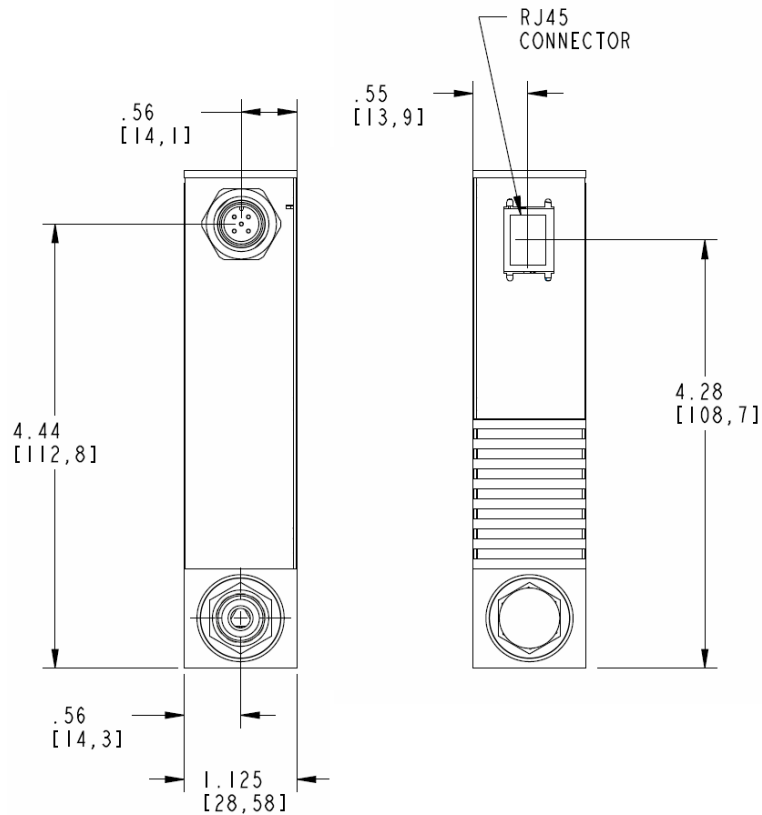

Figure 2: 4-VCR DeviceNet Inlet End (Left) and Outlet End (Right) Views - (Normally Closed Valve)

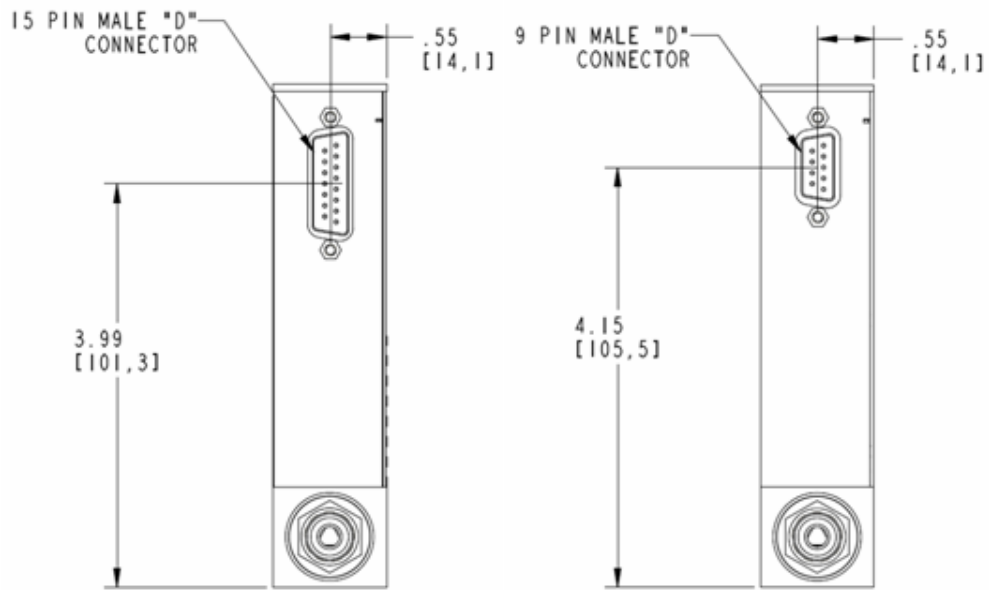

Figure 3: 4-VCR Inlet End - 15 pin D and 9 pin D Views (Normally Closed Valve)

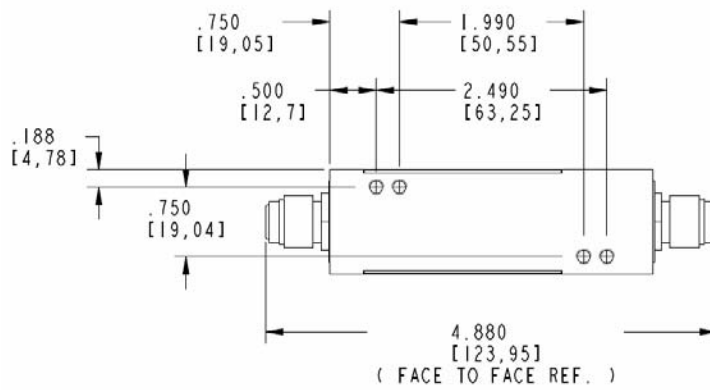

Figure 4: 4-VCR Bottom View

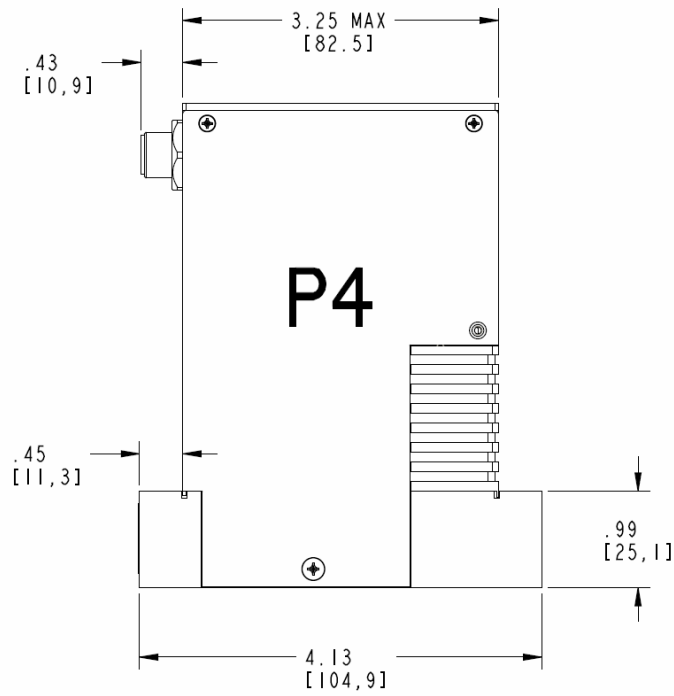

Figure 5: C or W Seal Side View – Normally Closed

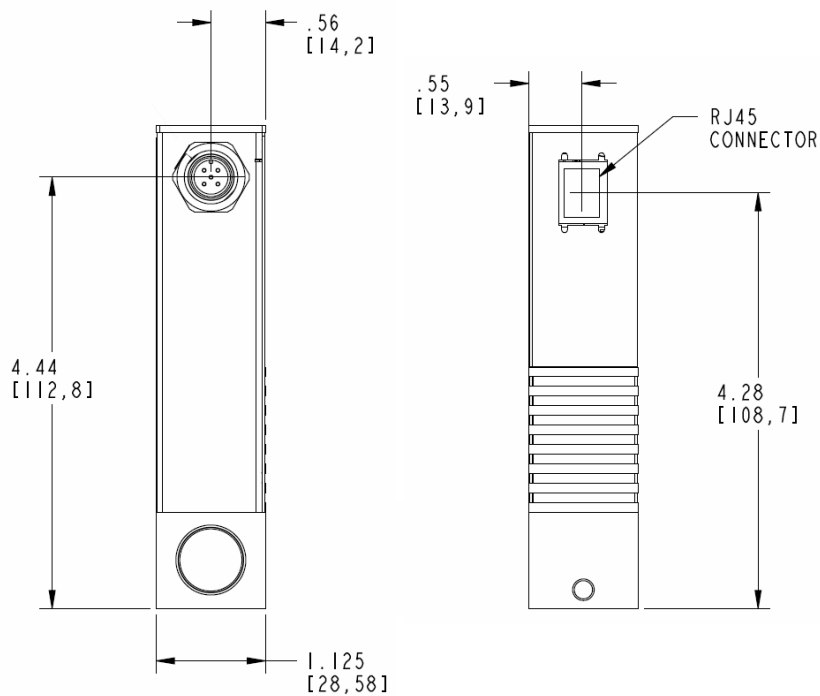

Figure 6: C or W Seal DeviceNet Inlet End (Left) and Outlet End (Right) Views – Normally Closed Valve

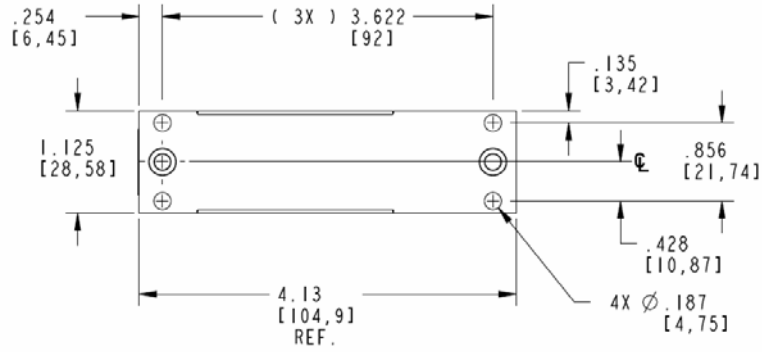

Figure 7: C and W Seal Bottom View

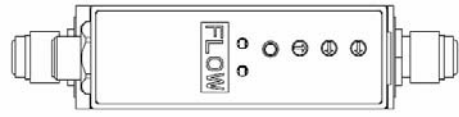

Figure 8: 4-VCR DeviceNet Top View

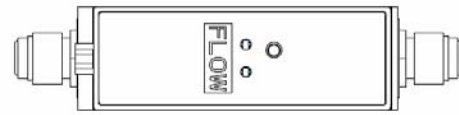

Figure 9: 4-VCR 9 pin D and 15 pin D Top View

Dimensions - P3B

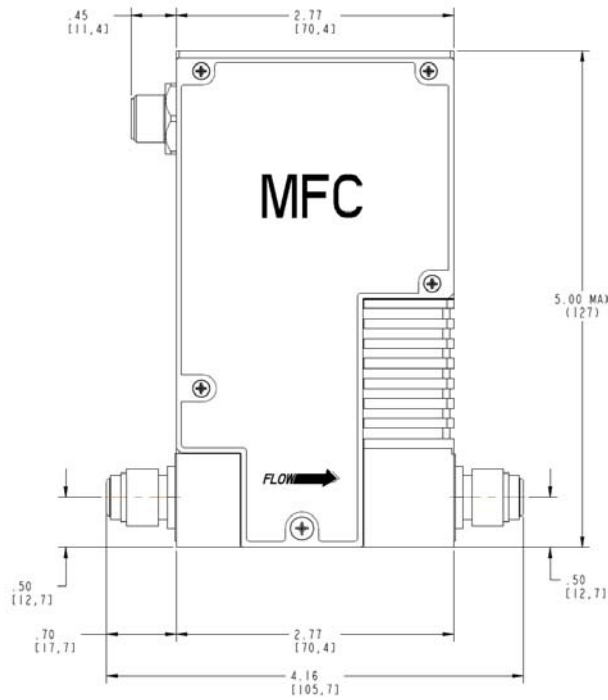

Figure 10: 4-VCR DeviceNet

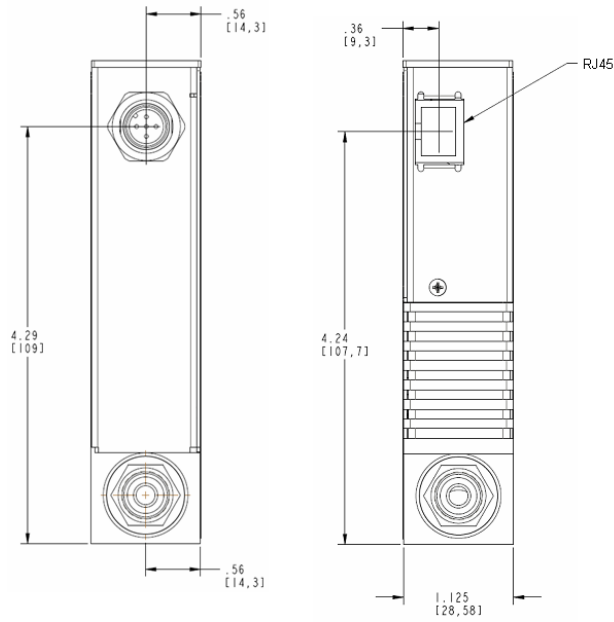

Figure 11: VCR DeviceNet Inlet End (Left) and Outlet End (Right) Views

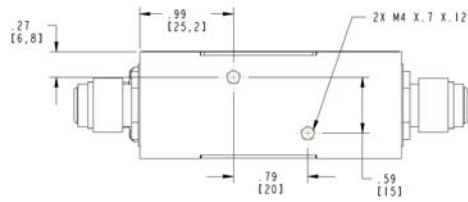

Figure 12: 4-VCR Bottom View

Serial Label

Each MFC has one serial number label. Each label shows the serial number, the model code, the full scale flow range, and the calibration gas. The label is located on the inlet end of the device enclosure.



Figure 13: Serial Number Label (sample)

Mounting Hardware

P4B MFCs with in-line fittings (VCR) have four threaded mounting holes located on the bottom or base of the unit: two #8-32 and two M4. Depending on the hole pattern chosen, use #8-32 UNC-2B or M4 hardware to mount the instrument. The figures beginning on page 26 show the location and dimensions of the mounting holes for standard axial fittings.

The P4B MFC's C-Seal and W-Seal downmount fittings are designed for device mounting using four M5-0.8 x 30 mm long socket head cap screws. In addition, C-Seal units may be mounted using 10-32 UNF x 1.25" long socket head cap screws if your mounting substrate requires.

P3B MFCs with in-line fittings (VCR) have two threaded mounting holes located on the bottom or base of the unit. Use M4 hardware to mount the instrument. The figures beginning on page 26 show the location and dimensions of the mounting holes for standard axial fittings.

Control Valve – Not a Shut-off Valve

The control valve is *not* a positive shutoff valve. Some leakage across the valve may occur. Refer to Appendix A, *Product Specifications*, page 89, for the leak integrity specifications. If necessary, install a separate positive shutoff valve in your system.



Note Connect the MFC to your system so that the gas flows in the direction of the flow arrow on the front of the unit.

Installation Procedure

Install the MFC



Note DO NOT make any electrical connections to the MFC until directed to do so.



Note Information on electrical connections (pinouts and settings) is found in the following chapter.

1. The MFC is prepared for cleanroom installation.

Follow standard cleanroom practices to ensure a clean installation:

- discard outer material outside of the cleanroom
- remove the outer packaging in the gray area
- carry the MFC into the clean area then remove the inner bag and any protective fitting covers just prior to installation. Remove plastic ethernet kit from inner plastic and DO NOT take them into clean room.
- Do not discard calibration sheet

Prepare the system according to your facility's gas handling procedures, including purging of the gas lines with appropriate purge gas, and notification to equipment personnel and haz/mat teams.



PERSONAL SAFETY HAZARDS! Gas systems can contain toxic, explosive, combustible, corrosive or other gases which can present life-threatening hazards. ALWAYS use appropriate personal protection equipment. NEVER open a gas line unless the system has been properly purged of harmful gases. Certain gas system components may contain hazardous residuals if not properly prepared. Consult with your facility safety engineers prior to working on any gas delivery system and notify all personnel in adjacent areas to take appropriate personal safety precautions BEFORE working on the equipment.

2. Prepare the connections fittings:

- Flow clean, dry purge gas across the fittings to minimize particle contamination prior to and during installation. Use only purge gases that are approved for your process.
- Use appropriate size and material gaskets (VCR or w-seal) or c-seals for the application. These are not included with the MFC.
- Install the MFC and secure according to the fitting manufacturer's instructions. DO NOT overtighten connections.



Note Before installing a Devicenet or an RS485 MFC be sure to set the Baud Rate and MACID for the device.



Figure 14: Devicenet MAC ID Switches

3. Perform appropriate helium leak checking of your gas lines and MFC connections to verify the integrity of the gas seals prior to supplying power to the MFC. Before connecting the cable leading to the MFC, verify all pinouts for power and signals match those for the I/O type being used. Information on each I/O type's pinouts are found in the following chapter.



Note When using Ethernet interface for setup, a crossover cable (similar to null modem) is required when the MFC is connected directly to a PC. When the MFC is on a network with a hub interface, a standard Ethernet cable should be used.

See Chapters 5 and 6 for details on setting up and using the Ethernet user interface.

4. Connect cable and power up the MFC. Record the IP address, Gas Type and Maximum Flow Rate (Full Scale Flow Rate) on the calibration sheet.
 Note: The P4B MFC's scrolling display shows the IP address, the Gas Type, and the Maximum Flow Rate. There is no display on the P3B.

Chapter Four: Analog and Digital Interface

Analog I/O Interface Cables

As of January 1, 1996, all products shipped to the European Community must comply with the EMC Directive 89/336/EEC, which covers radio frequency emissions and immunity tests. MKS products that meet these requirements are identified by application of the CE Mark.

This MKS product meets CE Mark requirements, per EMC Directive 2004/336/EEC. To ensure compliance when installed, an overall metal braided shielded cable, properly grounded at both ends, is required during use. MKS offers a variety of interface cables, listed in Table 12, page 27.

Table 7: MKS Interface Cables

	Power Supply End	
MFC End	15-Pin Type "D"	Flying Leads
15-pin Type D analog	CB147-1 CB259-5	CB259-6
9-pin Type D analog	CB147-12	Not Available



Note An overall metal braided, shielded cable, properly grounded at both ends, is required to meet CE Mark specifications.



Note To order an overall metal, braided, shielded cable, add an "S". after the cable type designation. For example, to order a standard connection cable to connect the MFC to a power supply with a 15-pin Type .D. connector, use part number CB259-5; for an overall metal braided, shielded cable use part number CB259S-5.

Generic Shielded Cable Description

MKS offers a full line of cables for most MKS equipment. Should you choose to manufacture your own cables, follow the guidelines listed below:

1. The cable must have an overall metal *braided* shield, covering all wires. Neither aluminum foil nor spiral shielding will be as effective; using either may nullify regulatory compliance.
2. The connectors must have a metal case with direct contact to the cable shield on the whole circumference of the cable. The inductance of a flying lead or wire from the shield to the connector will seriously degrade the shields effectiveness. Ground the shield to the connector before its internal wires exit.
3. With very few exceptions, the connector(s) must make good contact to the device's case (ground). Good contact is about 0.01 ohms and the ground should surround all wires. Contact to ground at just one point may not suffice.
4. For shielded cables with flying leads at one or both ends; it is important to ground the shield at each such end *before* the wires exit. Make this ground with absolute minimum length. (A ¼ inch piece of #22 wire may be undesirably long since it has approximately 5 nH of inductance, equivalent to 31 ohms at 1000 MHz). After picking up the braid ground, keep wires and braid flat against the case. With very few exceptions,

grounded metal covers are not required over terminal strips. If one is required, it will be stated in the Declaration of Conformity.

5. In selecting the appropriate type and wire size for cables, consider:

- Voltage ratings.
- Cumulative I²R heating of all the conductors (keep them safely cool).
- IR drop of the conductors, so that adequate power or signal voltage gets to the device.
- Capacitance and inductance of cables that handle fast signals (such as data lines or stepper motor drive cables).
- Some cables may need internal shielding from specific wires to others.

Analog Interface Input and Output Options

The P4B analog I/O MFC is available with either a 9 pin D male connector or a 15 pin D male connector for providing power and signal I/O.

Table 8: Analog Interface – 9 Pin D Males Pinouts – Model Code A

Pin 1	Valve Open/Close: Apply +5 to+15 VDC to Open; Pull to ground or apply -5 to -15 VDC to Close.
Pin 2	Flow Output Signal, 0 to 5 VDC (into high impedance load, minimum 10K-ohm)
Pin 3	+11 to +25 VDC :Power
Pin 4	Power Common (see Note 4 below)
Pin 5	No Connection
Pin 6	Setpoint Input, 0-5 VDC
Pin 7	Signal Common (see Note 4 below)
Pin 8	Signal Common (see Note 4 below)
Pin 9	Valve Test Point



Notes

1. Chassis ground is not available on a separate pin. Instead, it is carried out through the cable shielding. Be sure that the connector on the other end of the cable is properly grounded to its chassis ground.
2. The 0 to 5 VDC flow signal output comes from pin 2 and is referenced to pin 7 (signal common).
3. Use any appropriate 0 to 5 VDC input signal of less than 1K ohm source impedance referenced to pin 7 as the setpoint signal to pin 6.
4. A signal common line MUST be connected to the power common line at either at the tool end or at the MFC 9 pin D connector end of the cable to avoid setpoint/readback offsets. DO NOT connect a signal common line and the power common line at both ends of the cable as this will result in ground loops.

Table 9: Analog Interface – 15 Pin D Males Pinouts – Model Code B

Pin 1	Valve Test Point
Pin 2	Flow Signal Output, (0 to 5 VDC) (into high impedance load, minimum 10K-ohm)
Pin 3	Valve Close (Pull to Ground or Pull Low – 5 to -15 VDC)
Pin 4	Valve Open (Pull High +5 to +15 VDC)
Pin 5	Power Supply Common Digital Ground (see Note 4 below)
Pin 6	No Connection
Pin 7	+11 to +25 VDC
Pin 8	Setpoint Input (0 to +5 VDC)
Pin 9	Zero Function
Pin 10	Optional Input
Pin 11	Signal Common (see Note 4 below)
Pin 12	Signal Common (see Note 4 below)
Pin 13	No Connection
Pin 14	No Connection
Pin 15	Chassis Ground

**Note**

1. The “No Connection” pin assignment refers to a pin with no internal connection.
2. The 0 to 5 VDC flow signal output comes from pin 2 and is referenced to pin 12 (signal common).
3. Any appropriate 0 to 5 VDC input signal of less than 1K ohm source impedance referenced to pin 12 can be used to supply a setpoint signal to pin 8.
4. A signal common line **MUST** be connected to the power common line at either at the tool end or at the MFC 15 pin D connector end of the cable to avoid setpoint/readback offsets. **DO NOT** connect a signal common line and the power common line at both ends of the cable as this will result in ground loops.

The Optional Input (15 Pin D Analog Controllers Only)

The standard 15-pin MFC can control flow based on a 0 to 5 Volt signal from an external sensing device using the optional input feature (for a 0 to 10 Volt input range, contact the MKS Applications Department). A common application of this feature is for pressure control using input from a pressure transducer.

To use the optional input feature, route the 0-5 Volt output from the desired external device to the optional input pin 10.

**Note**

The optional input feature is only available on the 15-pin Type D connector with standard MKS pinout assignments. The 9-pin Type D connector does not support the optional input feature. Voltage applied to the optional input pin overrides the signal generated by the flow sensor internal to the MFC. The control electronics drives the valve so that the optional input signal

matches the setpoint. Use the same pin for the setpoint signal, regardless of whether you are using the optional input or the standard flow control signal. Although controlling to the external optional input signal, the metered flow output signal is still provided on the standard output pin 2.

Start-Up Procedure for the Analog MFC

1. Leak test the fittings on the unit using standard helium leak check procedures. Do not proceed to the next step until you are certain that there is no gas leakage.
2. Before connecting the cable leading to the MFC, verify all pinouts for power and signals match those for the connector being used.
3. Plug the power supply/readout cable (MKS or customer-supplied) into the connector (either a 9-pin or 15-pin D type) located at the inlet end of the device.
4. Plug the other end of the cable into an MKS or MKS-compatible power supply/readout unit.
5. Apply power to the device. Once the device is sufficiently warmed-up, you can proceed to zero it. See instructions in Section 7.

Warm Up Time

After installation and power connection, allow the MKS MFC to warm up for a minimum of 30 minutes. This is to account for both warm-up of the device electronics as well as for the device to reach ambient temperature conditions.

Zeroing the Device

Although MKS flow devices are zeroed at the factory prior to shipment, it is normal to check the zero and re-zero them, if needed, when they are first installed on the tool.

A mass flow meter or mass flow device will provide a zero output signal under no flow gas conditions.

Zero offset from improper zeroing procedures can contribute to flow measurement inaccuracy. This is more apparent at the lower end of the device flow range.

In order to complete a true zeroing of the device, ensure the following conditions are satisfied prior to beginning the procedure.

- Device is installed in the orientation intended for final use (i.e. horizontal base down, vertical flow up, etc.).
- Device is powered at operating temperature, preferably for 30 or more minutes.
- Devices subject to ambient temperatures other than room temperature (23° C) should be zeroed under those conditions.
- Pressure drop and flow across the device is reduced to zero. Depending on the gas panel configuration, this may be done by one of the referenced procedures. See Chapter 7 Maintenance for zeroing procedures.

How To Override the Valve (Controllers Only)

The valve override feature enables the control valve to be fully opened (purged) or closed independent of the setpoint command signal.

If the MFC is equipped with a 9-pin Type D connector:

To Open the valve, apply 5 to 15 VDC to Pin 1.

To Close the valve, apply -5 to -15 VDC Low to Pin 1 or connect Pin 1 to Signal Ground.

Normal Setpoint operation occurs when Pin 1 is allowed to float.

If the MFC is equipped with a 15-pin Type D connector:

- *To Open* the valve by applying a +5 to 15 VDC to pin 4.
- *To Close* the valve by applying a -5 to 15 VDC low to pin 3 *or* connect pin 3 to the power ground pin.

Priority of the Valve Commands

The MFC executes commands based on a hierarchical command structure. The highest priority command is Valve Open, followed by Valve Close, and Setpoint Control. Therefore, if the flow controller is operating under Setpoint Control, you can send a Valve Open command to force the valve to the full open position.



Note

When both the Valve Close and Valve Open pins are pulled down, the Valve Open command takes precedence and the valve is moved to the open position.

Digital Interface Input and Output Options

The P4B digital I/O MFC is available with either the DeviceNet communications protocol or the RS485 communications protocol. The P3B digital I/O MFC is available with the DeviceNet communications protocol.

DeviceNet Digital Interface Using 5 Pin Microconnector

The MFC has one 5-pin, male DeviceNet connector that provides the communications interface with the DeviceNet network, electrical power from the network bus, and shielding for the instrument signals.

Table 10: Digital Interface - DeviceNet Connector Pinout – Model Code 6

Pin Number	Signal Name
1	Drain
2	V+
3	V-
4	CAN_H
5	CAN_L

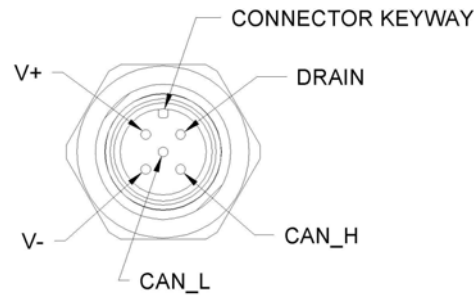

Figure 15: DeviceNet Connector Pin Diagram

Overview of MFC DeviceNet Digital Operation

The P4B (P3B) MFC DeviceNet Mass Flow Device complies with the ODVA DeviceNet Specification Volume I and Volume II [1, 2], and the SEMI Standards Common and Specific Device Models [3, 4]. Refer to those documents for a complete functional description of the MFC Mass Flow device along with the MKS P4 Devicenet Profile Document, 1042923-001. Please contact MKS for this document.

Power Requirements

The MFC requires an input voltage of 11.0 to 25.0 VDC with <500 mA max @ 11 VDC (230 mA @ 24 VDC, nominal). The input voltage, provided by the DeviceNet network, is introduced to the mass flow controller through the 5-pin micro-style connector located on side of the instrument.

DeviceNet Controls and Indicators

The top panel of the MFC contains several DeviceNet controls and indicators.

The mass flow device has two standard bi-color (green/red) DeviceNet status LEDs, (Module Status LED and Network Status LED) located on top of the instrument. The power-up sequence of these LEDs conforms to the requirements in the ODVA DeviceNet Specification, Volume 1 [1]. DeviceNet Network Status LED (MOD & NET)

The Network Status LED indicates the status of the communications link. If no problems are detected, the Network Status LED illuminates a solid green. A red, dark, or flashing green Network Status LED indicates a fault condition on the network.

Table 11: Network Status LED Indicators

LED Status	Meaning
Solid Green	Communications link is OK. The device is online and connections are established.
Flashing Green	The device is online but no connections are established. The device has passed the Dup_MAC_ID test and is online, but has no established connections to other nodes.
Solid Red	Critical link failure. The device has detected an error that prevents network communication (Duplicate MAC_ID or bus-off).
Dark	Not powered / Not online. The device has not completed the Dup_MAC_ID test, or the device is not powered;

	check the module status LED.
--	------------------------------

DeviceNet Baud Rate and MAC ID Switches

The baud rate and MAC ID (node address) for your device can be set through software commands using standard DeviceNet protocol over the network, or manually using the rotary switches located on the top panel of the device. The baud rate and MAC ID switches allow you to easily configure units without an operational network, or to network multiple units quickly.

The baud rate and MAC ID rotary switches support an assigned *network* position, labeled on the device as “PGM” to indicate software operation.

If the rotary switch is in the network (PGM) position at power-up, the baud rate or address is read from the non-volatile memory. Any changes to the values must be made over the network; any changes in the rotary switch positions after power-up are ignored.

If the rotary switch is *not* in the network (PGM) position at power-up, the baud rate or address is read directly from the switches.

Note The DeviceNet General Error Codes are listed in the ODVA DeviceNet Specification, Volume 1 [1].

DeviceNet Baud Rate Switch

The 4-position rotary switch is used to select the DeviceNet baud rate. The choices are: PGM (the baud rate is read from the non-volatile memory), 125, 250, and 500 Kb. (*Factory Default is 500 Kb.*)

The switch positions are numbered in a clockwise direction, to correspond to the increasing address values.

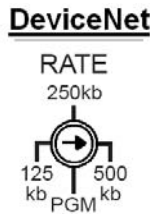

Figure 16: Devicenet Baud Rate Switch

DeviceNet MAC ID (Node Address) Switches

Two 10-position rotary switches, shown below, are used to set the MAC ID (node address).

The MAC ID is an integer identification value assigned to each node on the DeviceNet network.

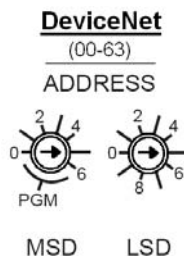

Figure 17: Devicenet MAC ID Switches

The valid MAC ID switch positions are 0 to 63. Use the switch on the left to set the most significant digit (MSD), that is, the factor of ten (10, 20, 30...60). Use the switch on the right to set the least significant digit (LSD), that is, the increments of one (1, 2, 3...9). The switch positions are numbered in a clockwise direction, to correspond to the increasing address values. (*Factory Default is 55.*)



Note Setting the switches to a value that is greater than 63 is the same as setting the rotary switch to the “PGM” position (the baud rate is read from the non-volatile memory).



Note The MAC ID switch on the top of the device must be set to the network (PGM) position before power up in order for changes to be made over the network. Any changes in the rotary switch positions after power up are ignored.

Unrecoverable Fault Condition

A hardware problem with the EEPROM, or a memory problem with the RAM are major unrecoverable faults. This fault condition sets its exception status bit, and the Module Status LED illuminates solid red, complying with Volume I of the DeviceNet Specification.



Note A major unrecoverable fault prevents operation because the device cannot communicate on the network. Contact MKS Instruments, Inc. for assistance.

Power Up

At power-up, flow device performs checks on its communications link and internal diagnostic checks of the EEPROM and RAM. The results of these checks are indicated by the color (green or red) and condition (solid or flashing) of the status LEDs on top of the instrument. The following LED sequence occurs when the MFC is powered up (times are approximate):

1. The Module Status LED flashes first GREEN for ¼ second, then RED for ¼ second, then turns OFF.
2. The Network Status LED flashes first GREEN for ¼ second, then RED for ¼ second, then turns OFF.
3. The Module Status LED flashes from GREEN to RED for five seconds while the device is initializing. The Network Status LED remains OFF.
4. The Module Status LED illuminates solid GREEN when initialization is completed.
5. When the device establishes communication with other devices on the network, the Network Status LED illuminates GREEN.



Note If the power up LED sequence does not function properly, contact MKS for assistance. See Table 7: Network Status LED Indicators for more information on the operation of the Network Status LED and the Module Status LED.

Warm-Up and Zero the MFC

After installation and power up, allow the MFC to warm up for a minimum of 30 minutes, then refer to the installation section to Zero the MFC.

Warm Up Time

After installation and power connection, allow the MKS MFC to warm up for a minimum of 30 minutes. This is to account for both warm-up of the device electronics as well as for the device to reach ambient temperature conditions.

Zeroing the Device

Although MKS flow devices are zeroed at the factory prior to shipment, it is normal to check the zero and re-zero them, if needed, when they are first installed on the tool.

A mass flow meter or mass flow device will provide a zero output signal under no flow gas conditions.

Zero offset from improper zeroing procedures can contribute to flow measurement inaccuracy. This is more apparent at the lower end of the device flow range.

In order to complete a true zeroing of the device, ensure the following conditions are satisfied prior to beginning the procedure.

- Device is installed in the orientation intended for final use (i.e. horizontal base down, vertical flow up, etc.).
- Device is powered at operating temperature, preferably for 30 or more minutes.
- Devices subject to ambient temperatures other than room temperature (23° C) should be zeroed under those conditions.
- Pressure drop and flow across the device is reduced to zero. Depending on the gas panel configuration, this may be done by one of the referenced procedures. See Chapter 7 Maintenance for zeroing procedures.

RS485 Digital Interface Using 9 Pin D Male Connector

The RS485 MFC has one 9 pin D male connector that provides the communications interface with the RS485 master slave network, electrical power from the network bus, and shielding for the instrument signals. There are no analog I/O signals on this device.

Table 12: Digital Interface – RS485 Using 9 Pin D – Model Code 5

Pin 1	No Connection
Pin 2	No Connection
Pin 3	+ 11 to 25 VDC Power In
Pin 4	Power Return
Pin 5	No Connection
Pin 6	RS485 Return
Pin 7	RS485 +
Pin 8	RS485 -
Pin 9	Shield

RS485 Communications Protocol

The MFC controller (up to 15) acts as a slave device on an RS485 multi-drop bus. It continually listens for transaction requests from the host controller, processes requests addressed to it, and sends replies as needed.

For a complete description of this multi-drop protocol see the MKS Document, Command Specification, P4 RS485 Interface, 1042925-001. Please contact MKS for this document.

RS485 Controls and Indicators

The top panel of the MFC contains several controls and indicators.

Table 13: RS485 Module Status LED Indicators

LED Status	Meaning
Flashing Red	The device is online and functioning properly. The Module Status LED flashes red when receiving commands from Host.
Solid Red	Critical link failure. The device has detected an error that prevents network communication (Duplicate MAC_ID or bus-off.)
Dark	Not powered / Not online. The device is offline or the device is not powered; check the network status LED.

For RS485 the baud rate and MAC ID (node address) switches are the *only* way to configure an RS485 MFC.

Baud Rate Switch

For RS485: The 3-position rotary switch is used to select the RS485 baud rate. The choices are: 9.6, 19.2, and 38.4 Kb. *Factory default is 38.4 Kb.*

The switch positions are numbered in a clockwise direction, to correspond to the increasing address values.



Figure 18: RS485 Baud Rate Switch

MAC ID (Node Address) Switches

Two 10-position rotary switches, shown below, are used to set the MAC ID (node address).

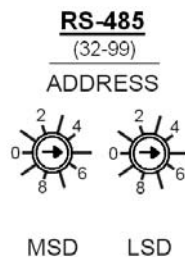

Figure 19: RS485 MACID Switches

The MAC ID is an integer identification value assigned to each node on the RS485 network.

Unrecoverable Fault Condition

A hardware problem with the EEPROM, or a memory problem with the RAM are major unrecoverable faults. This fault condition sets its exception status bit, and the LED illuminates solid red

**Note**

A major unrecoverable fault prevents operation because the device cannot communicate on the network. Contact MKS Instruments, Inc. for assistance.

Chapter Five: Ethernet Interface Setup and Configuration

The Ethernet interface is a supplemental interface that can be used for MFC setup, configuration, and diagnostics purposes. It is not used to control the MFC during normal operation. To access the diagnostic features of the MFC via the Ethernet port, follow Steps 1 and 2.

Step 1: Install the Java™ Plug-in (for single IP address)

The MFC interface software uses a web-based Internet Explorer interface that requires a Java Technology plug-in to display real-time data plots.

If you are installing the MFC on a network that has web access AND you are setting up multiple IP addresses, then go to “*Option 3: For Multiple IP Address Setup*” on page 52 and skip the steps below. The “Multiple IP Address Setup” procedure enables you to access the web for download at completion.

OTHERWISE perform the following steps:

1. Download the (2) files listed below from the MKS website (www.mksinst.com/MDsw.html) by clicking on the link “MFC java plugin file for web access.” The MKS download includes an installation script to properly load the plug-in.
 - o Java installer: jinstaller.exe
 - o Installation script: InstallPlot.bat
2. Copy the installer and script file to your hard drive, then double-click on the InstallPlot.bat file. This file connects to the Sun Microsystems download site according to the following command:
 - o `jinstall.exe http://java.sun.com/update/1.4.2/1.4.2-b28.xm`
3. Follow the onscreen prompts to install the Java application.



4. Read the license agreement, select “I accept...”, click “Next” to continue installation.

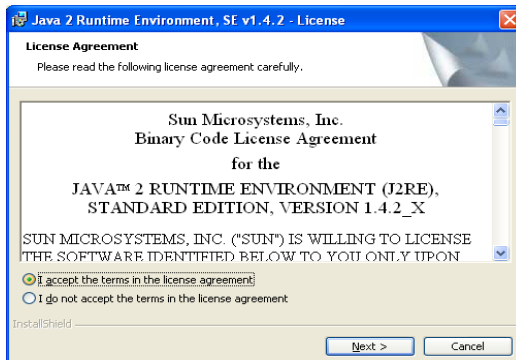

5. Select the “Typical” installation option and follow the prompts to install the Java plug-in.

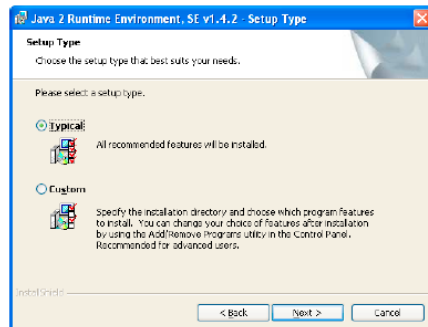

6. Java plug-in is now complete.

Step 2: Setup Network for Communication through Ethernet

There are three possible ways to setup your network for communication through Ethernet. Choose the correct option based on the following criteria:

Option 1 (see below) [single port/single device]

- The Java applet discussed in Step 1 on page 47 has already been installed on your computer.
- You have no need to connect to the Internet.
- You only have one IP address, i.e. 192.168.2.X, to connect with.
- If your computer has more than one network card, this option may not work. Use option 2.

Option 2 (see page 50) [single port/multiple devices]

- The Java applet discussed in Step 1 on page 47 has already been installed on your computer.
- You have no need to connect to the Internet.
- You have one or Multiple IP addresses you want to connect with, i.e. 192.168.2.X, 10.X.X.X, etc.

Option 3 (see page 52) [multiple ports/multiple devices]

- The Java applet discussed in Step 1 on page 47 has or has not installed on your computer.
- You need to be able connect to the Internet while connecting to one or multiple units.
- You have Multiple IP addresses to connect with, i.e. 192.168.2.X, 10.X.X.X, etc.

Option 1: Network Automatic Setup

A software script allows you to rapidly create a network connection to the MFC. Once connected a series of web-browser type windows allow you to easily monitor and configure the MFC.

1. Logon to the MKS website (www.mksinst.com/MDsw.html) and download a copy of the IP setup script, HostIP.cmd by clicking on the HostIP.cmd link.
2. Copy the setup script HostIP.cmd to your root directory (Typically C:).
3. Connect a **crossover** network cable to the MFC and your laptop computer. A crossover cable is required when the MFC is connected directly to a computer. When the MFC is connected to a network using a hub interface, a standard Ethernet cable can be used.
4. From your computer's "Start" menu, select "Run..." then enter the word "command" and click OK.

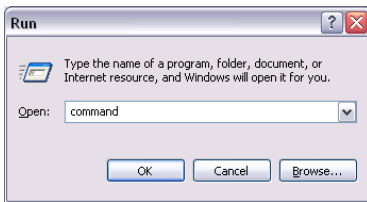

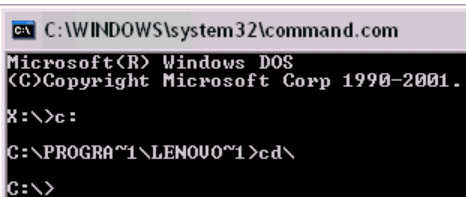

5. At the command prompt, if it's not already in the root directory "C:\>", then you can use the following commands to change the directory: "CD\" will bring you to the root of whatever drive that is currently set. If this is not the root directory, enter the command "C:". Use the "CD\" command again if necessary. This will bring you to the C:\> prompt. See the example below:



6. Enter the command "HostIP x y z" where (x) stands for the IP address of your Host computer, (y) stands for the subnet mask and (z) stands for the gateway. The system will setup a new host IP address and display it as shown in the example below:

 **Note** The HostIP.cmd script looks for a network connection with the name "Local Area Connection". If the network connection you're using does not have this name and can be renamed, this is easiest. If not, then you'll need to use one of the other manual options.

 **Note** The HostIP.cmd script does not need the subnet mask (y) or gateway (z) to work. If only the Host IP address (x) is sent with the command, the script assigns its own subnet mask (255.0.0.0) and gateway (10.0.0.0).

 **Note** The MKS IP Address format is 192.168.2.X, so the Host IP Address must be of the same format. A recommended Host IP address is 192.168.1.Y with a Subnet Mask of 255.255.252.0, where Y is some number between 5 and 254. The combination of a Subnet Mask with the value of "252" in the third segment along with a 192.168.1.Y IP allows for a connection to any IP address in the 192.168.1.X, 192.168.2.X & 192.168.3.X range. By setting the Host IP to 192.168.1.X, there is assurance that there will never be a conflict between the Host and the MKS MFC.

```
C:\>hostip 192.168.0.10 255.255.0.0
*****
Ip Address.....: 192.168.0.10
Subnet Mask.....: 255.255.0.0
Default Gateway.....: 10.0.0.0
*****
Setting the new IP address ...
Local Area Connection is set to static
```

To restore to a dynamic IP address, run the HostIP script with an argument of “auto” as shown below:

```
C:\WINNT\system32\cmd.exe
C:\>HostIP auto
Setting the new IP address ...
Local Area Connection is set to dynamic
C:\>
```

These commands may also be entered directly in the “Run...” window. Instead of typing “command” simply type “c:/HostIP x y z” (without “”) or “c:/HostIP auto” (without “”).

7. After running the HostIP command, launch Internet Explorer, enter “http://xx.xx.xx.xx” in the address field, where xx.xx.xx.xx stands for the IP address of the MFC you wish to connect to, and click “Go.” Internet Explorer will open and display the device Monitor screen which displays the device’s gas settings, model code, valve type and the Digital I/O connection status (if applicable). The Serial Number can always be found in the bottom left-hand corner of the browser window.

For more information on the web-based program, go to Chapter 6 on page 57.

Option 2: Manual Setup

If you have not setup automatic network script in Option 1, a manual setup is required to access the MFC Ethernet interface.

1. Connect a crossover network cable to the MFC and your laptop computer.

A crossover cable is required when the MFC is connected directly to a computer. When the MFC is connected to a network using a hub interface, a standard Ethernet cable can be used.

2. Open the Local Area Connection by doing one of the following options:

Option 2.1:

Select **My Network Places** (On Desktop typically). Right-Click on the icon, then select **Properties**.

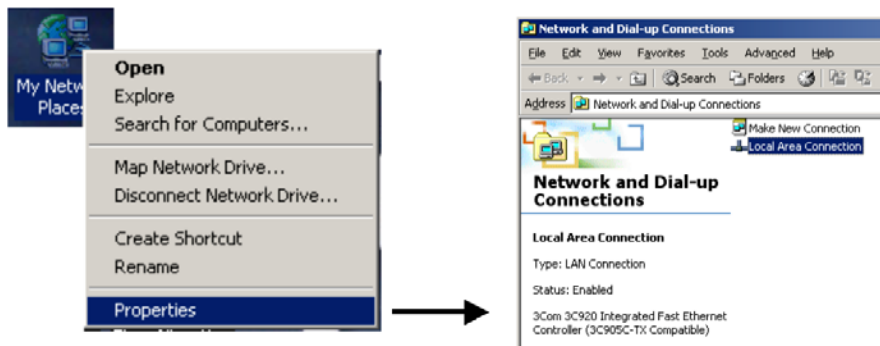

In the “Network and Dial-Up Connections” window, Double-click on “Local Area Connection.” Not all Local Area Connections have the same name, yours may have a different name.

Option 2.2:

From your computer's "Start" menu, select "Settings" → Network and Dialup Connections → Local Area Connections

3. Select **Properties**.

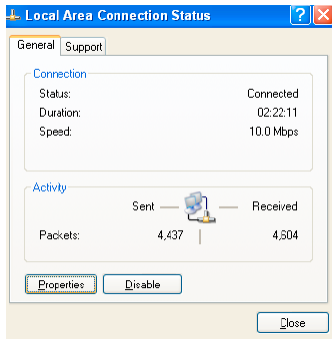

4. Select **Internet Protocol (TCP/IP)**, then select **Properties**.

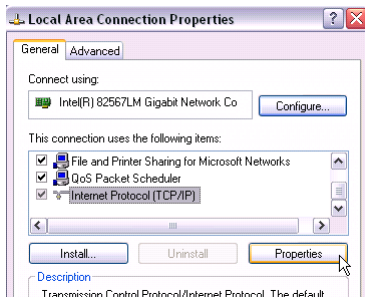

5. Select **Use the following IP address**.

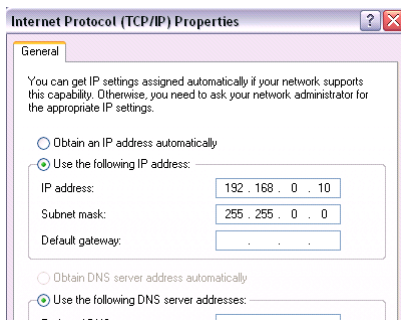

6. Enter the IP address **192.168.0.10**. Now click in the Subnet mask field and the Subnet mask 255.255.255.0 should appear. Change the 3rd 255 to "0" as shown in the figure above. So the final subnet mask will be **(255.255.0.0)**. Also make sure that the "Use the following DNS server Addresses" is also selected. Leave this blank.

Additional IP Addresses

In the case that you need to be able to connect to more than one IP Address, simply click on the “Advanced” button at the bottom of the current window. Once the “Advanced TCP/IP Settings” window pops up, verify that you’re on the “IP Settings” tab and then click “Add” in the “IP Addresses” section. If you have a different IP Address on your network, e.g., 10.X.X.X, you will need to add the IP Address 10.X.X.X, where “X” is a number from 0 to 254 that is unique from any other IP address on your network. Now click in the Subnet mask field and enter the Subnet mask (255.0.0.0).

7. Close out all dialog boxes by selecting **O.K.**, **Close**, etc. as required.
8. Launch Internet Explorer (or a similar program) and enter “http://xx.xx.xx.xx” in the address field, where xx.xx.xx.xx stands for the IP address of the MFC you wish to connect to, and click “Go.” Internet Explorer will open and display the device Monitor screen which displays the device’s gas settings, model code, valve type and Digital I/O connection status (if applicable). The Serial Number can always be found in the bottom left-hand corner of the browser window.



For more information on the web-based program, go to Chapter 6 on page 57.

Option 3: For Multiple IP Address Setup

1. From your computer’s “Start” menu, select “Run...” then enter the word “command” and click OK.

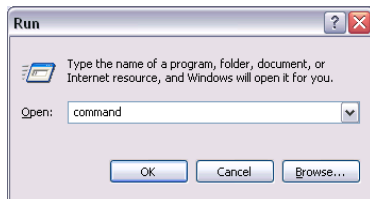

2. At the command prompt, if it’s not already in the root directory “C:\>”, then you can use the following commands to change the directory: “CD\” will bring you to the root of whatever drive that is currently set. If this is not the root directory, enter the command “C:.”. Use the “CD\” command again if necessary. This will bring you to the C:\> prompt. See the example below:

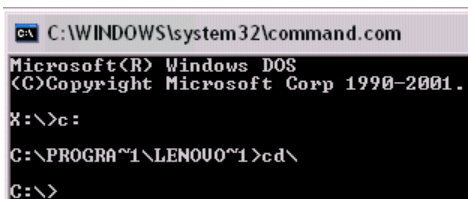

3. Now, before going any further, it is important that you have an active network connection that allows you to connect to the Internet. If you do not have an active connection, please set that up and then continue.

- At the command prompt, enter the command “ipconfig /all” (as shown below) then press Enter.

```

C:\WINNT\system32\cmd.exe
C:\>ipconfig /all

Windows 2000 IP Configuration

Host Name . . . . . : MUA-E-0029
Primary DNS Suffix . . . . . :
Node Type . . . . . : Hybrid
IP Routing Enabled. . . . . : No
WINS Proxy Enabled. . . . . : No
DNS Suffix Search List. . . . . : mkinst.com

Ethernet adapter Local Area Connection:

Connection-specific DNS Suffix . : mkinst.com
Description . . . . . : 3Com 3C920 Integrated Fast Ethernet
Controller (3C905C-TX Compatible)
Physical Address. . . . . : 00-B0-D0-78-78-F4
DHCP Enabled. . . . . : Yes
Autoconfiguration Enabled . . . . . : Yes
IP Address. . . . . : 150.104.220.210
Subnet Mask . . . . . : 255.255.0.0
Default Gateway . . . . . : 150.104.100.1
DHCP Server . . . . . : 150.104.100.58
DNS Servers . . . . . : 150.100.100.30
                        150.100.100.89
Primary WINS Server . . . . . : 150.100.100.51
Lease Obtained. . . . . : Wednesday, February 07, 2005 11:49:2
Lease Expires . . . . . : Saturday, February 12, 2005 11:49:24

C:\>
    
```

The data inside the highlighted area (lower section, between IP Address and Primary WINS Server) are what is needed for the steps below.

- Open the Local Area Connection by doing one of the following options:

Option 5.1:

Select **My Network Places** (On Desktop typically). Right-Click on the icon, then select **Properties**.

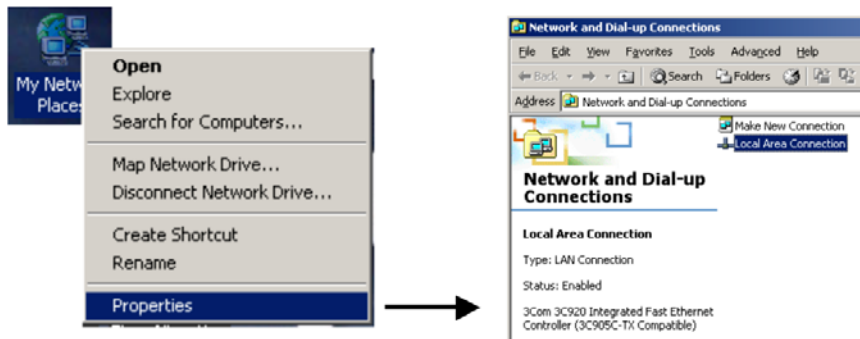

In the “Network and Dial-Up Connections” window, Double-click on “Local Area Connection.” Not all Local Area Connections have the same name, yours may have a different name.

Option 5.2:

From your computer’s “Start” menu, select “Settings” → Network and Dialup Connections → Local Area Connections

- Select **Properties**. In the Properties window select **Internet Protocol (TCP/IP)**, then select **Properties**

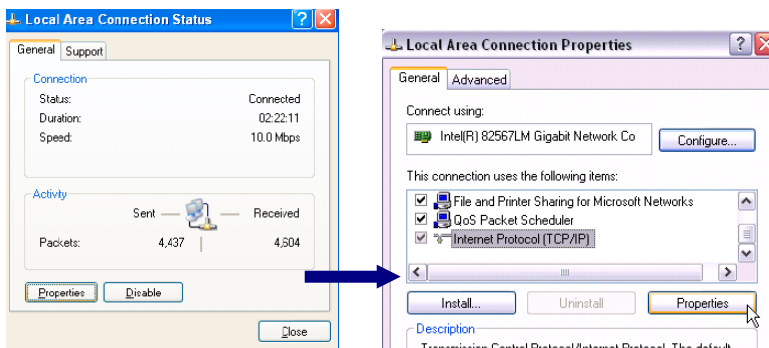

7. Select **Use the following IP address**. Now do the following to configure your computer so that it can still connect to the Internet:
 - Type in the “IP address”, the “Subnet mask” and the “Default gateway” fields with values returned from the “ipconfig /all” query in the DOS command window.
 - Select “Use the following DNS server addresses:”
 - Type in the Preferred DNS server and the Alternate DNS server fields with values returned from the “ipconfig /all” query in the DOS command window. An example is shown below:

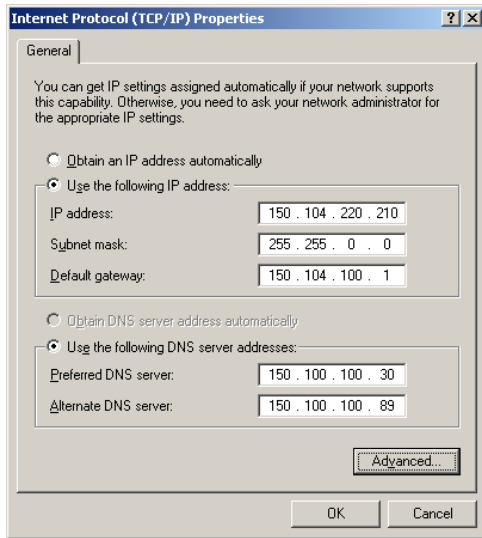

8. Click the “Advanced...” button at the bottom of the window. The following window will be displayed:

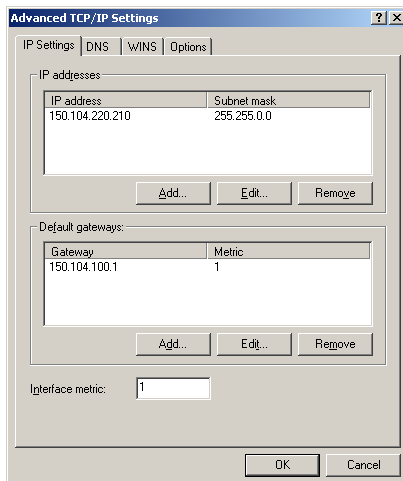

10. Verify you're on the "IP Settings" tab and then do the following to configure your computer to talk to the MFC and any other devices with an IP address:
 - o Click "Add..." in the "IP address" section and enter the IP address **192.168.0.10**. Now click in the Subnet mask field and the Subnet mask 255.255.255.0 should appear. Change this value to 255.255.0.0. Then click "OK."

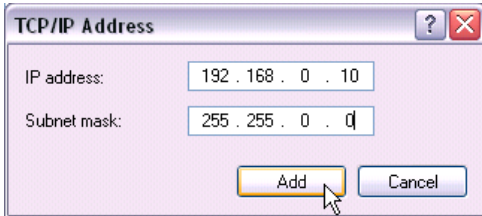

11. Now click "Add..." in the "Default gateways" group. Enter the Gateway value you will use to connect to the MFC. Typically a gateway value will be the IP address with a (1) on the end. The Metric value will always be (1). Then click "Add."

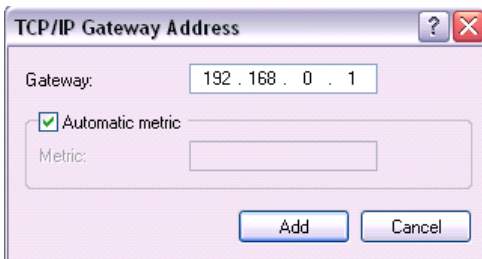

** You can use Automatic Metric or enter (1)

12. In the case that you need to be able to connect to more than one IP Address, i.e. not all devices on your network use a 10.X.X.X address; more addresses can be added by repeating steps 10 and 11 above. If you have another MFC, you may also need to add the IP Address 10.0.0.X, where "X" is a number from 0 to 254 that is unique from any other IP address on your network. The Subnet mask for this IP address is 255.0.0.0, and the typical Default Gateway is 10.0.0.1.
13. Click the "WINS" tab.

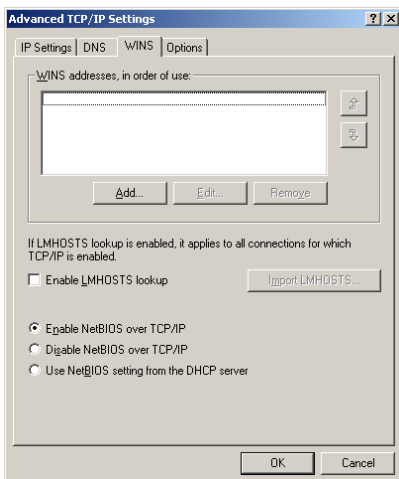

14. In the “WINS addresses, in order of use” section, click “Add...” Enter in the Primary WINS server address that was returned from the “ipconfig /all” query in the DOS command window, and click “Add.” If there were any alternate WINS servers listed in the DOS window, now enter them. If not, go ahead to the next step.

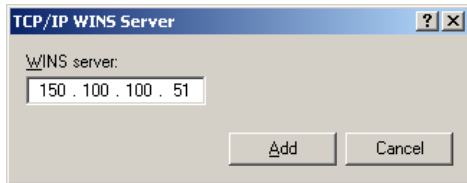

Example is shown below:

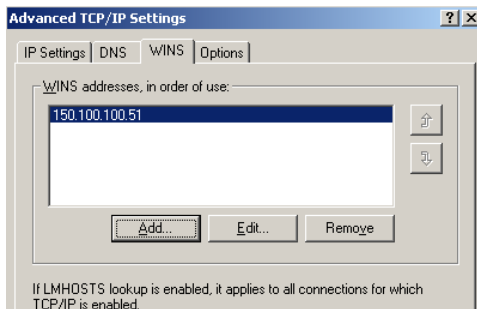

15. Close out all dialog boxes by selecting **O.K.**, **Close**, etc. as required.
16. You are ready to connect to multiple IP addresses from your computer. You can connect both to the Internet and to your MFC local network.
17. Launch Internet Explorer (or a similar program) and enter “http://xx.xx.xx.xx” in the address field, where xx.xx.xx.xx stands for the IP address of the MFC you wish to connect to, and click “Go.” Internet Explorer will open and display the device Monitor screen which displays the device’s gas settings, model code, valve type and Digital I/O connection status (if applicable). The Serial Number can always be found in the bottom left-hand corner of the browser window.



For the plot web page to work in the MFC, a java plug-in has to be installed on your computer.

With the multiple IP addresses setup, if the Java plug-in has NOT already been installed, the IE browser will automatically connect to the correct web site for the downloading the first time someone connects to a MFC and clicks on the “Plot” page. If, for some reason, this does not work please follow the Step 1 instructions (see page 47).

For more information on the web-based program, go to Chapter 6 on page 57.

Chapter Six: Embedded Web-Based GUI and Diagnostics

Logging On to Your MFC

Before trying to logon to your MFC you must have your network setup correctly. To do this, complete the steps listed in Chapter Three, *Ethernet Interface Setup and Configuration*, starting on page 47.

Once you complete the steps in Chapter Six, launch Internet Explorer (or a similar program) and enter “http://xx.xx.xx.xx” in the address field, where xx.xx.xx.xx stands for the IP address of the MFC you wish to connect to, then click “Go”. Internet Explorer will open and display the Device page in Monitor Mode.

The modes are described in detail below.

Monitor Mode

Holding true to its name, “Monitor Mode” allows the user to only *Monitor* the MFC performance aside from performing diagnostics. In order to configure the MFC, i.e. zero the device, configure the PID parameters, change the IP Address, etcetera, you must enter “Setup” mode. See *Setup Mode*, page 63.

Each of the pages, i.e. tabs, in Monitor Mode are listed and described below in detail.

Device Page – Monitor Mode

This page, which contains the general information for the MFC, is where you are initially directed once you logon to the MFC.

What’s Displayed

The Device Page displays the device’s selected (operating) gas, Semi gas number, calibration gas, minimum and maximum full scales allowed for the device, the device’s current full scale for the selected gas and the current operating pressure setting. In addition, you can see the device information and the Digital I/O connection status (if applicable).

**Note**

The MFC’s **serial number** can always be found in the bottom left-hand corner of the browser window.

Figure 20, next page, shows a screen capture of the Device Page for the MFC.

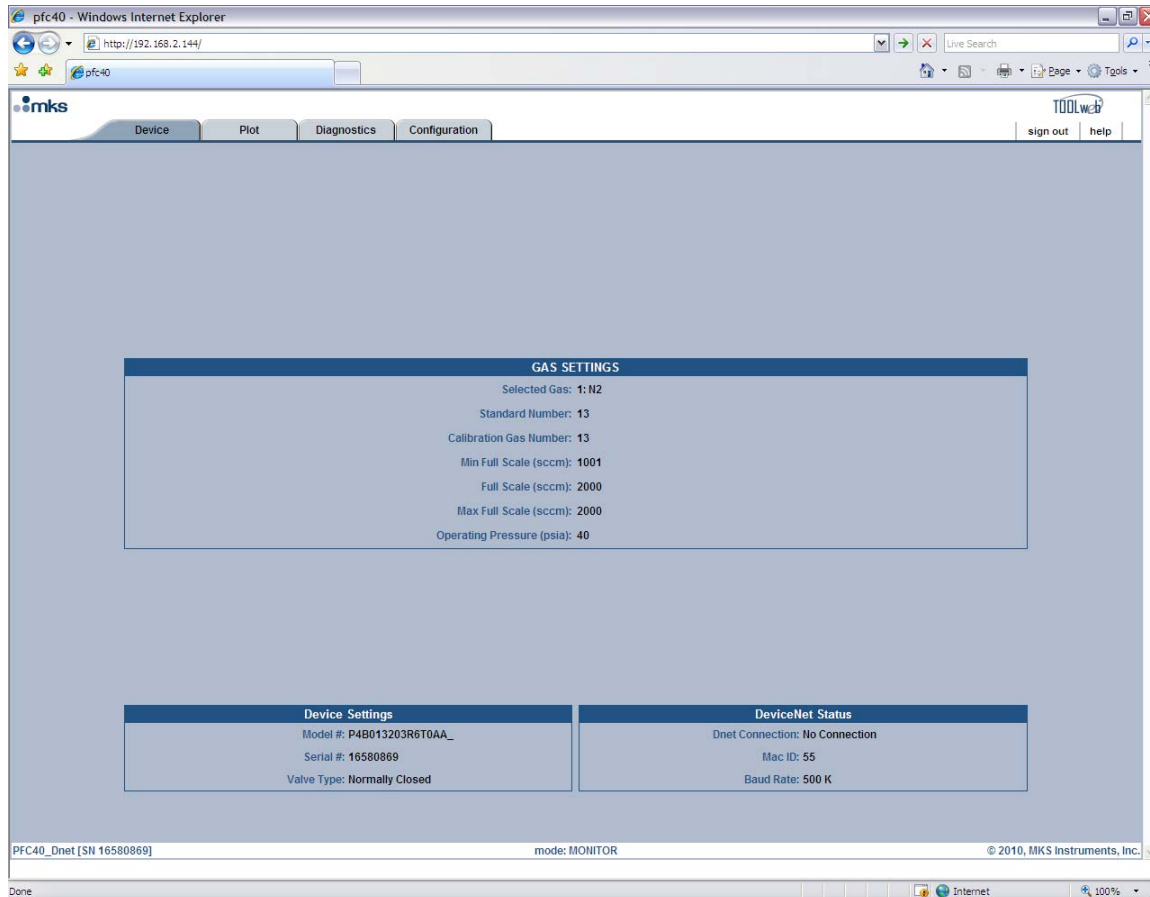

Figure 20: Embedded GUI, MFC Device Page in Monitor Mode

Plot Page – Monitor Mode

This page enables you to plot and see real-time performance of the device. In Monitor Mode you are able to select variables to plot, the rate at which to display them, and save the data that has been plotted.



Note The Plot Page requires a java applet to use the plot program. This applet, which must be installed on the computer trying to view the page, can be downloaded by following the instructions listed on page 47. **Error! Reference source not found.**

Selecting Variables To Plot

On the right-hand side of the Plot page you should see the Variables section. Here you have the ability to select one or more variables to plot.

- *To plot one variable:* click on the variable you wish to plot.
- *To plot two or more variables:* either select the variables one-by-one while holding your keyboard's control "Ctrl" key down or select all the variables by selecting the first variable in the list and then selecting the last variable listed while holding your keyboard's "Shift" key down.

Selecting Rate

Directly below the list of variables is the Rate selection drop down menu. Here you are able to select the sampling rate at which you'd like to plot the variables. Available rates are 1, 2, 5, 10, 50 and 100 Hz.

Starting and Stopping the Plot program

Below the Rate selection is the Start/Stop button for the plot program. You must click on this button to start the plot program and click on it a second time to stop the program.

Options (Trace Autoscroll, Rescaling Y Axis, Rescaling X Axis, Save to File)

Below the Start/Stop button, you should see the Options section. Here you are able to start/stop the autoscrolling feature, rescale the Y-Axis, rescale the X-Axis or save the plot data to a file. These options are described in detail below:

- Trace Autoscroll*** → unchecking this checkbox will stop the plot program from scrolling in the X-direction. This option only has an effect while the program is running. Rechecking this checkbox will enable the plot program to resume scrolling. The X-Axis scroll bar may be used for manual scrolling.
- Rescaling Y-Axis*** → next to where it says “Y scale:” enter in the scale (Min) to (Max), and then click on the “Rescale Y-Axis” button. This option only has an effect if the “Trace Autoscroll” checkbox is unchecked or the plot program is stopped. Otherwise the Y-Axis will automatically scale itself to fit all variables being plotted.
- Rescaling X-Axis*** → entering a value next to where it says “X scale (seconds):” adjusts the number of seconds spanned across the X-Axis, e.g. entering a value of ten seconds sets the X-Axis so that it will show ten second segments at a time. To use this feature, enter the value and then click on the “Rescale X-Axis” button. This option can be used at anytime.
- Save to File*** → the “Save to file” option can be used at anytime once you’ve started the plot program. The data stored consists of the data collected from the time the Start button was pressed to the time the “Save to file” button is pressed. The file will be saved in a (.csv) format which can be later imported into a spreadsheet for further analysis.

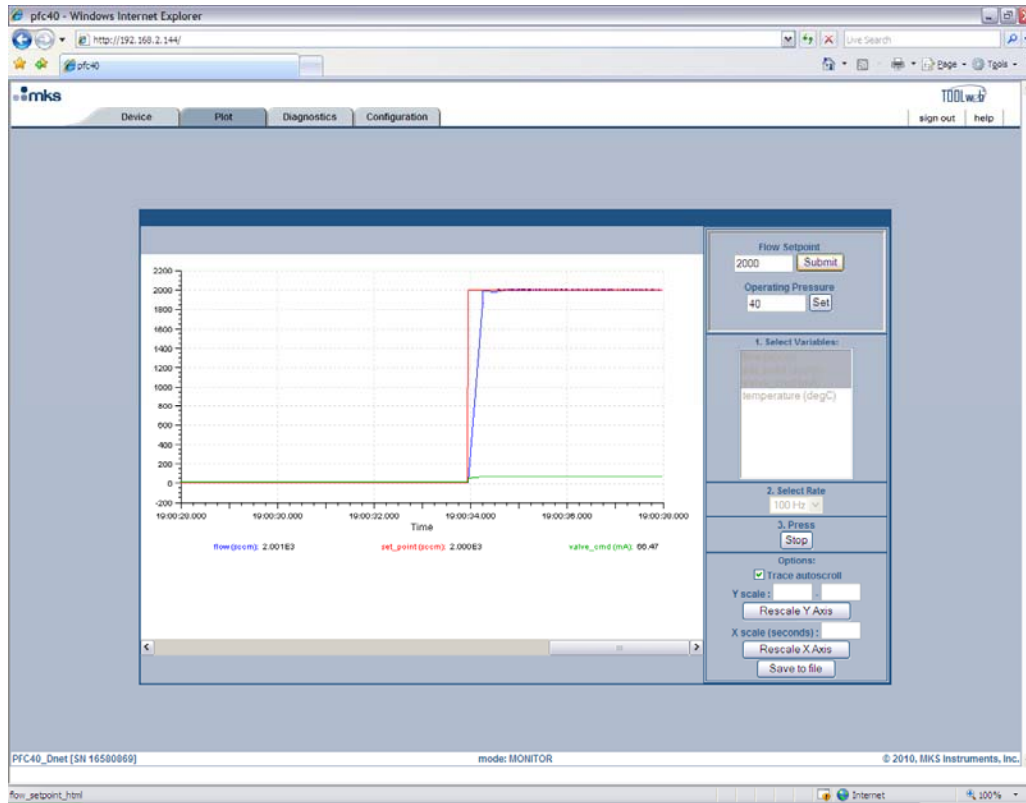

Figure 21: Embedded GUI, Plot Page in Monitor Mode

Diagnostics Page – Monitor Mode

The Diagnostics Page consists of a few basic diagnostic tests. In this section the user is given the ability to run basic diagnostic tests on the flow and temperature. These tests can be run individually or all at once. These tests are explained in more detail below.

Device Diagnostics

The tests listed in this section are designed to insure that there are no major electrical problems and that the sensors are working properly. These tests are described in detail below:

Raw Flow → this basic test is a simple diagnostic check for the flow circuit to verify that the sensor and the electronics are working properly. To run this test, select the checkbox next to where it says “Raw Flow:” and then press the “Run the test” button. When the test finishes you will either see the word “Pass” or “Fail” next to the checkbox. If the test passes, then the flow circuit is good. If it fails, then there may be a problem.

Temperature → this basic test is a simple diagnostic check for the temperature circuit to verify that the sensor and the electronics are working properly. To run this test, select the checkbox next to where it says “Temperature:” and then press the “Run the test” button. When the test finishes you will either see the word “Pass” or “Fail” next to the checkbox. If the test passes, then the temperature circuit is good. If it fails, then there may be a problem.

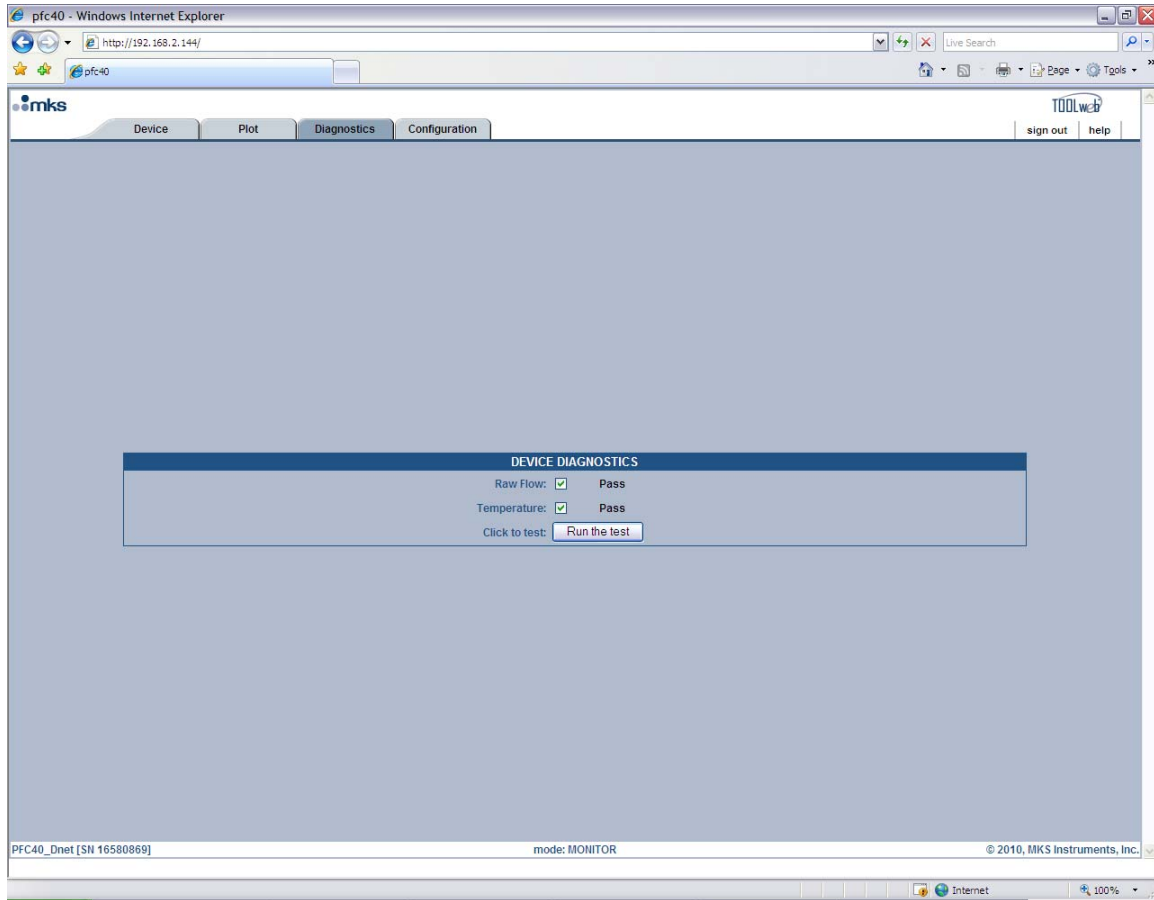

Figure 22: Embedded GUI, Diagnostics Page

Configuration Page – Monitor Mode

This page displays the TCP/IP settings and the current Firmware version for the MFC. In “Monitor Mode” you are only able to view this information. At the bottom of this page you are able to enter the password to change into “Setup Mode.” The Factory-shipped password is “config” (without the “”). Figure 23, below, shows a screen capture of the Configuration Page in “Monitor Mode.”

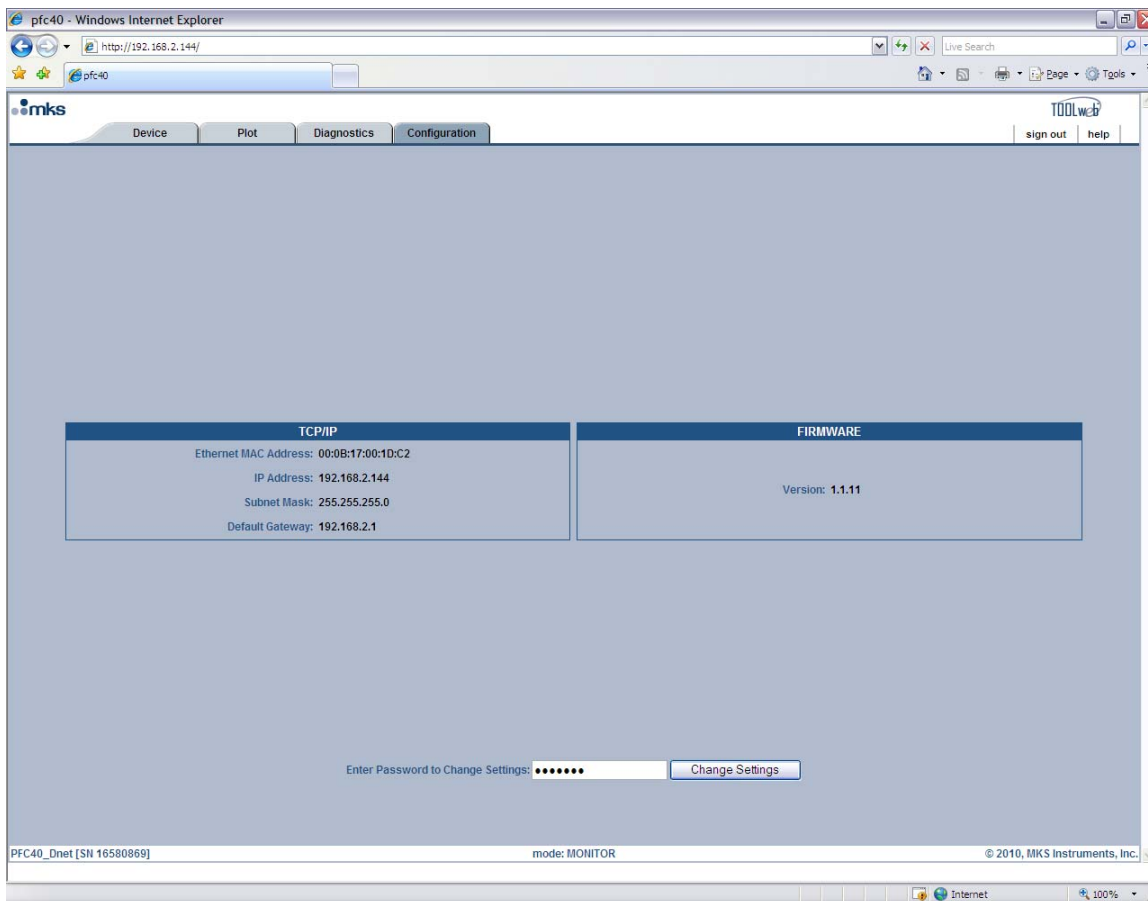

Figure 23: Embedded GUI, Configuration Page in Monitor Mode

Setup Mode

In “Setup Mode” the user is able to configure the MFC, i.e. zero the device, change the IP address, configure the operating pressure, etc. To enter this mode, while in “Monitor Mode”, go to the “Configuration Page” and enter the Factory-shipped password “config” (without “”). Once you press the “Change Settings” button you will be directed to the “Configuration Page” in “Setup Mode.” You should now see a green banner that lines the top of the page that says, “The device is now in SETUP mode.” (See Figure 24)

Each of the pages, i.e. tabs, in “Setup Mode” are listed and described below in detail starting with the Device Page. Please note that this section will only describe in detail the features that are different from those in “Monitor Mode.” For a complete understanding of each page, also read the *Monitor Mode* section starting on page 57.

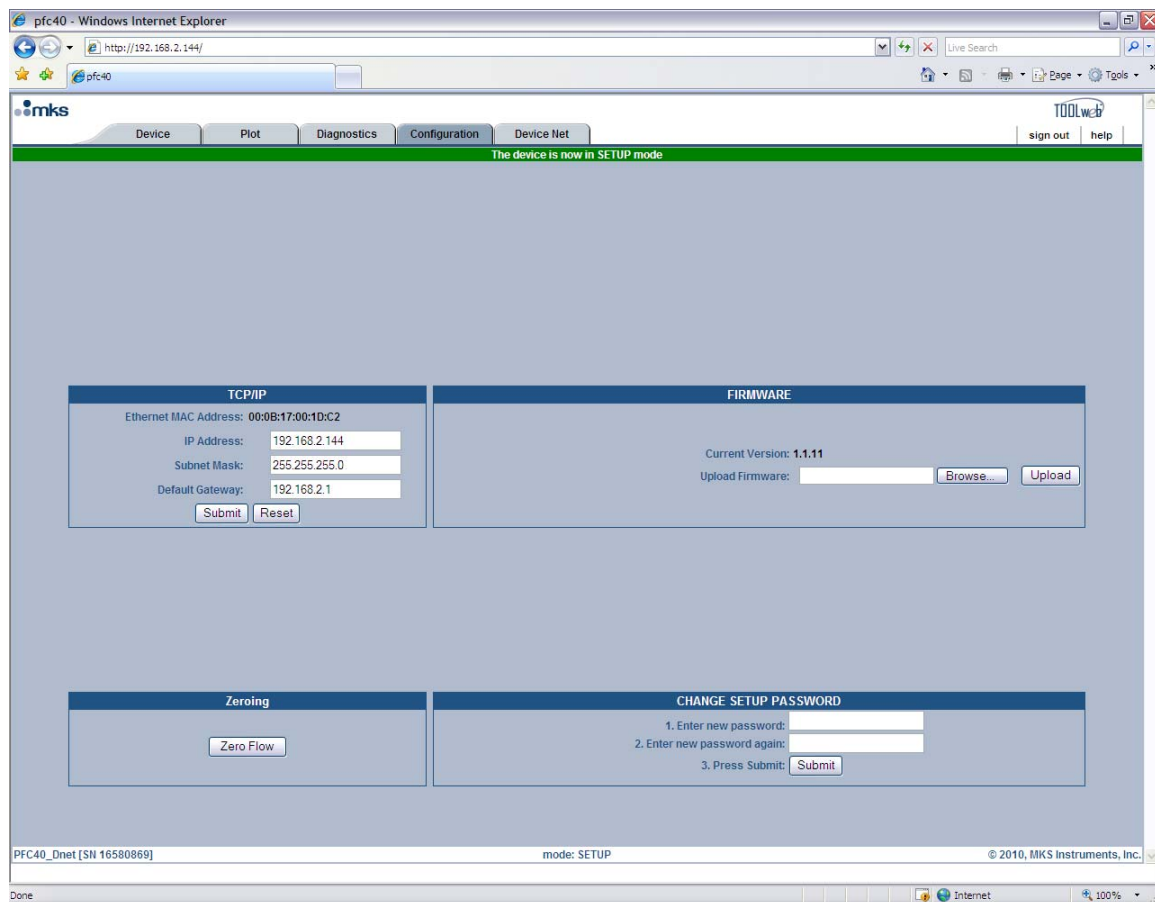
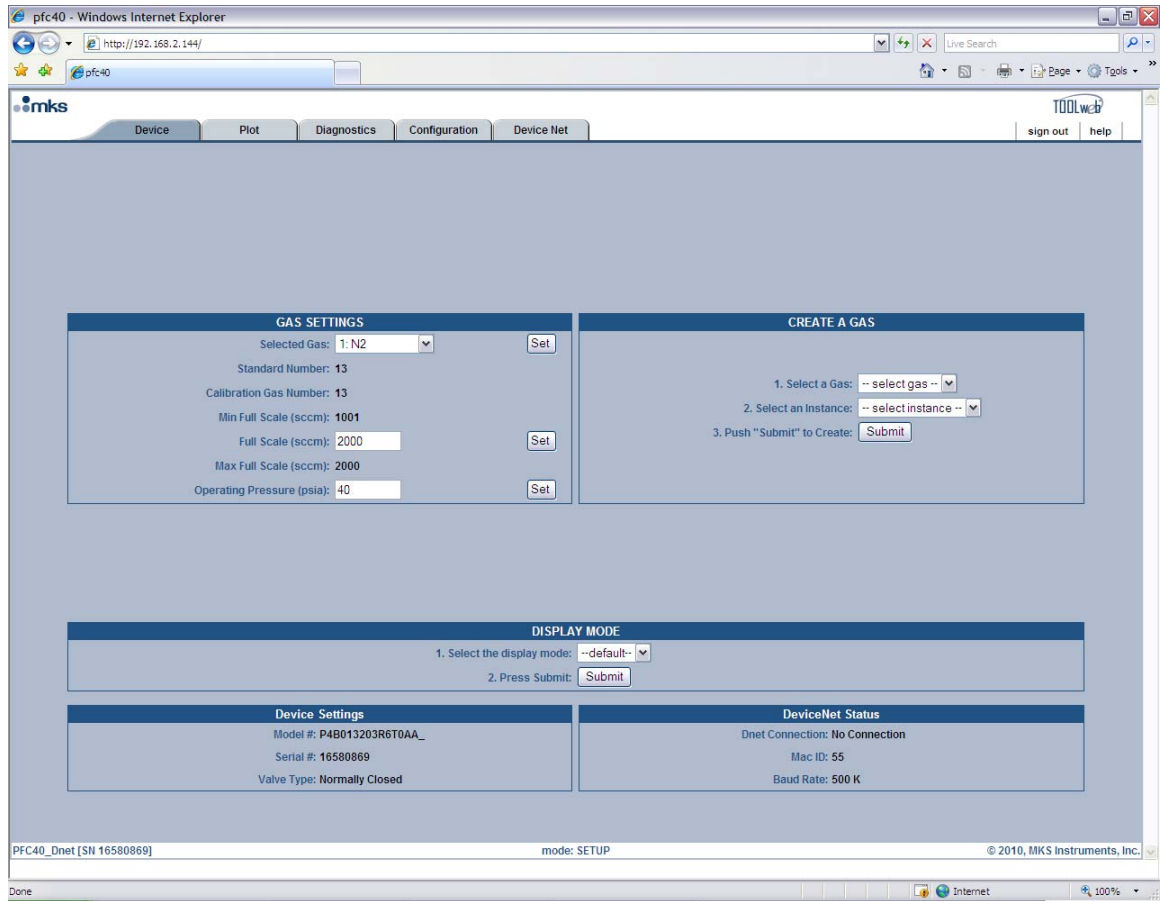

Figure 24: Setup Mode (Configuration Page)



Device Page – Setup Mode

In “Setup Mode” this page gives you the ability to modify the gas settings.

Figure 25: Embedded GUI, Device Page in Setup Mode

Gas Settings: The Device Page enables the user to change the MFC’s gas settings. To change the gas settings review the following possible operations and go to the appropriate page.

- To create a new gas instance, see page 65.
- To change the full scale range of the current gas instance, see page 65.
- To set the MFC to a different gas instance, see page 66.

Creating A New Gas Instance

(Refer to Figure **Error! Reference source not found.** during the following steps.)

In the “Create A Gas” section of the Device Page:

1. Click on the “select gas” drop-down menu arrow and find the gas you’d like to create.
2. Click on the “select instance” drop-down menu arrow and find an instance that says “No Gas.” *Please note that you can write or re-write to any instance except instance 32, which is the Factory calibration.*
3. Press the “Submit” button.
4. This process typically takes under two minutes to complete. When the process is completed, the browser will display a green banner across the top of the Device Page that says, “Gas Selection Update SUCCEEDED.”
5. You should now see the newly created gas and its attributes now listed in the “Gas Settings” section of the Device Page. At this point, if you want to change the full scale, then go ahead to the next section on page 65. **Otherwise you need to cycle the power to the MFC. Once you cycle the power, click on the refresh button of the browser. Once the MFC powers up, the browser will reload and start on the Device Page in Monitor Mode.**

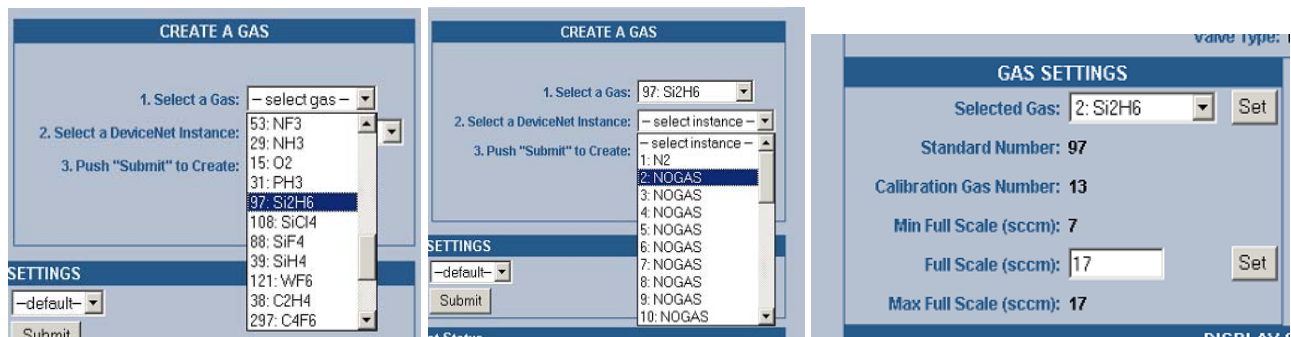

Figure 26: Embedded GUI, Creating A New Gas Instance

Changing the Full Scale Flow Range

In the “Gas Settings” section of the Device Page the user is able to change the full scale gas flow range to any number between the “Min Full Scale (sccm)” and the “Max Full Scale (sccm)” values.

To do this, enter in the desired full scale range in the “Full Scale (sccm):” field and then press the “Set” button. This operation typically takes less than one minute. **Once completed, cycle the power to the MFC. Once you cycle the power, click on the refresh button of the browser. Once the MFC powers up, the browser will reload and start on the Device Page in Monitor Mode.**

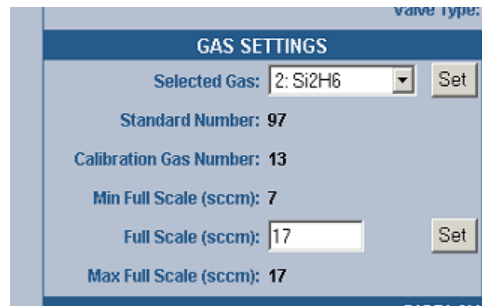

Figure 27: Changing the Full Scale Flow Range

Changing the Active Gas Instance

In the “Gas Settings” section of the Device Page the user is able to change the active gas instance.

To change the “Selected Gas”, click on the drop-down menu’s arrow and select one of the gases that have been created. *Please note that you are able to select the Factory calibration gas instance (32) but you can not change anything. Instance (1) is an exact replica of that instance if it has not been overwritten by the user on previous modifications to the gas tables.*

Once you’ve selected the instance you want press the “Set” button. The gas will change within (10) seconds. You’ll notice that the “Standard Number” and the minimum and maximum full-scale ranges will change also.

Plot Page – Setup Mode

In “Setup Mode” this page enables the user to adjust the PID settings to optimize control performance. To learn more about how to tune the MFC to your system see page XX in the xxx section. This section only deals with setting the values.

Figure **Error! Reference source not found.**, below, is a screen capture of the Plot Page in “Setup Mode.” The control parameter section is located above the “Select Variables” section in the top right-hand corner of the page. This page enables you to send a setpoint to the MFC through Ethernet (see notes below), watch the MFC’s performance on the plot, and adjust the PID parameters accordingly to optimize the performance of the MFC. You should find that tuning a device has never been easier.



Note

For Analog units, sending a setpoint through Ethernet will not work unless the Analog checkbox is selected. This checkbox tells the device to bypass the analog setpoint on the analog/power interface. To begin sending setpoints through the analog interface again, either uncheck the Analog checkbox or close the browser.

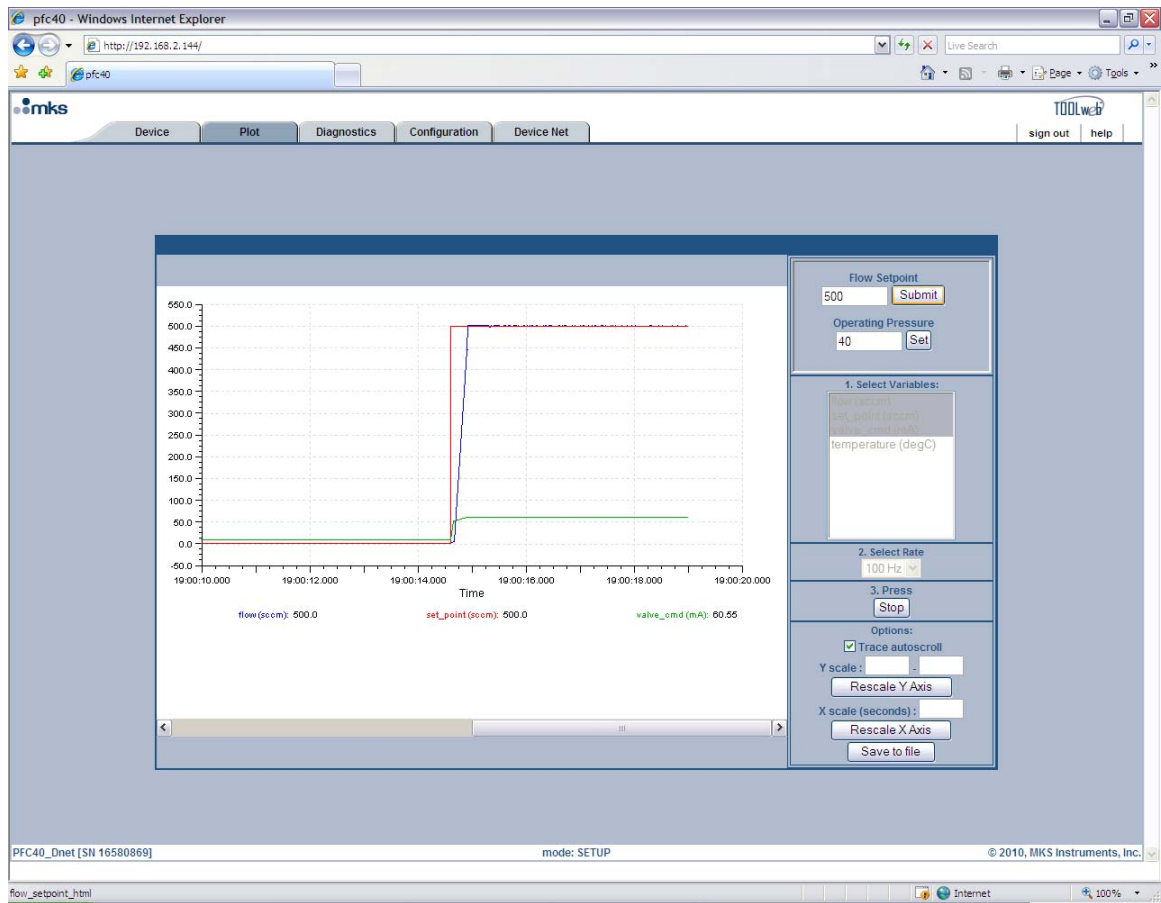

Figure 28: Embedded GUI, Plot Page in Setup Mode

Before a MFC leaves the factory the performance is checked with Nitrogen in a typical application. During this test the control parameters are set so that the device's performance is optimized. These factory set control parameters are then saved to the device and can be restored to the device at any time by pressing the "Factory Restore" button. To change the current PID variables in the device, enter in a value for the Kp (gain), Ki (integral) and/or Kd (derivative) parameters and press the "Submit" button. For information on how to tune your MFC for optimal performance please see *Tuning the MFC Mass Flow Controller*.

Diagnostics Page – Setup Mode

There is no difference between this page in "Setup Mode" versus this page in "Monitor Mode." To learn more on its features, please see the *Diagnostics Page* section on page 60.

Configuration Page – Setup Mode

As was noted earlier, the Configuration Page is where you are initially directed once you've entered "Setup Mode." Here the MFC can be zeroed, the "Setup Mode" password can be changed, changes can be made to the Ethernet settings and firmware can be updated.

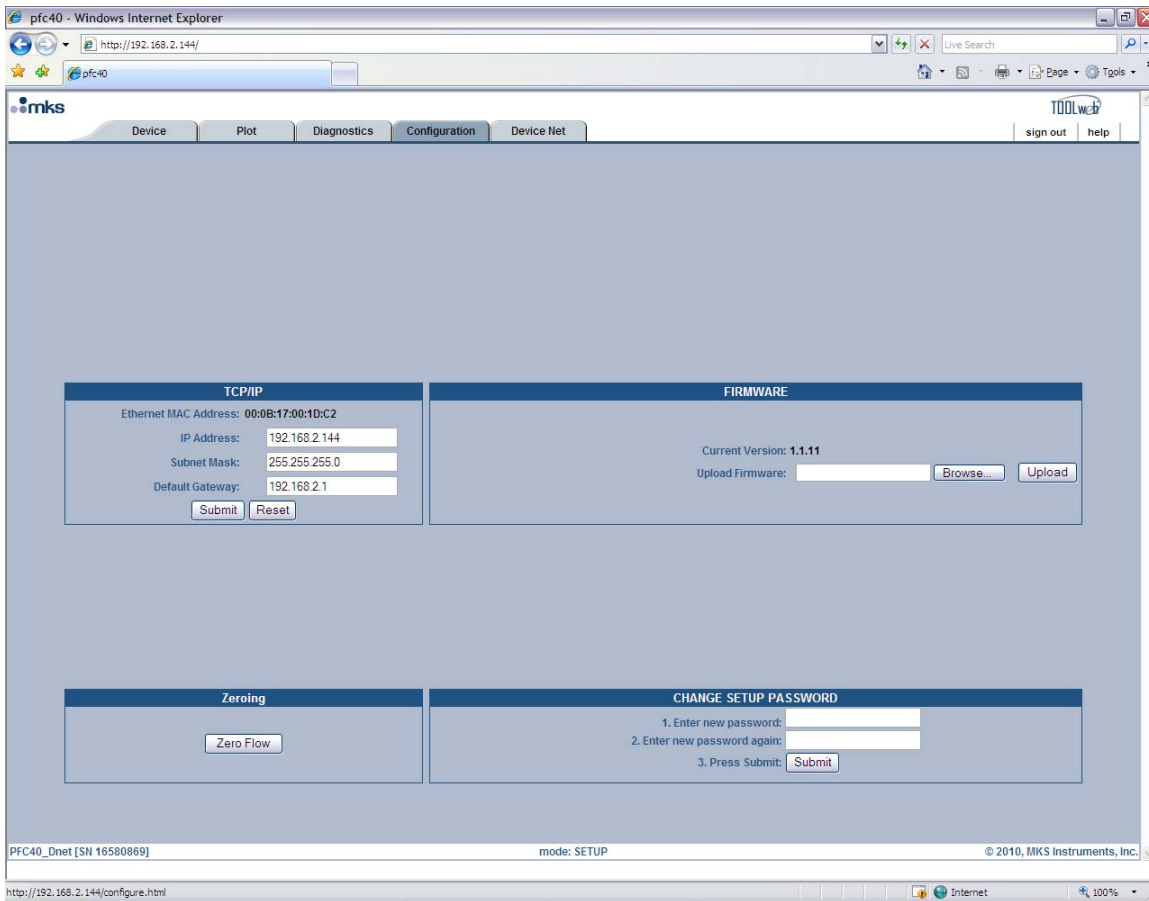

Figure 29: Embedded GUI, Configuration Page in Setup Mode

Zeroing the MFC

For the MFC there will be a “Zero Flow” option. Before zeroing the value make sure the “Zero Adjustment” procedure on page **Error! Bookmark not defined.** has been followed correctly. To zero the flow, press the “Zero Flow” button. A green banner across the top of the page will tell you if the device received the command and is processing. Zeroing typically will take (10) seconds. The MFC will be unresponsive during this time.



Caution Zeroing the flow incorrectly can cause system failure. Make sure that the “Zero Adjustment” procedure on page **Error! Bookmark not defined.** is followed properly.

Changing the Setup Mode Password

To change the “Setup Mode” password from the default password “config,” follow the steps in the “Change Setup Password” section.

Changing the Ethernet (TCP/IP) Settings

The TCP/IP section allows you to change the IP Address, Subnet Mask, and Default Gateway for the MFC.



Caution If you are unfamiliar with setting TCP/IP settings for the MFC, please contact your company’s IT personnel or local MKS representative for help. If settings are done incorrectly, you may no longer be able to connect to the MFC over Ethernet.

To set a new IP Address, enter in the IP address and press the “Submit” button. Pressing the “Reset” button will reset the entry fields to what was in them prior to you making any changes. For the new IP address to take effect the power to the MFC must be cycled. To use the Embedded GUI, you must now change the URL to reflect the new IP address, e.g. <http://xx.xx.xx.xx>, where xx.xx.xx.xx is the new IP address for the MFC.

Updating Firmware

Updating firmware is the responsibility of your local MKS representative. If any updates are “necessary”, then your local representative will be in contact to set up a time to complete the upgrade. Please note that a “necessary” update is one that is deemed “Critical” by the factory.

Optional PC Page (Analog 15 pin D Devices Only)

The Optional PC page is only available in Setup Mode for Analog 15-Pin devices. Here the MFC can be setup to control to an external signal, e.g. a Baratron capacitance manometer to control pressure. The external signal full scale input voltage can be set to 10 VDC (*default*) or 5 VDC, and the TCP/IP settings can be viewed. Figure 30, below, shows a screen shot of this page.



Note Once the Optional Input is enabled, any setpoint sent to the device will cause the device to control relative to the external signal input. To set the device so that it controls to its own internal sensor the optional input must be disabled.

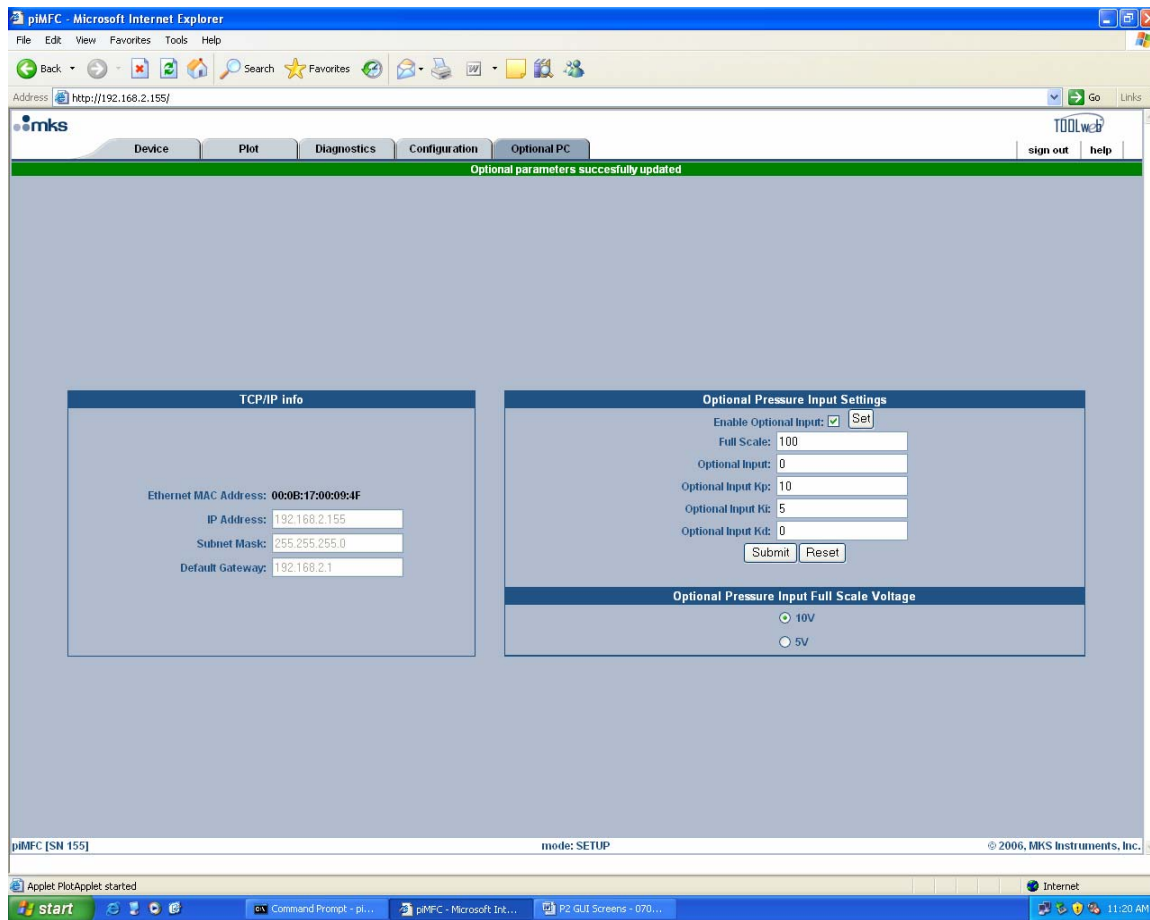

Figure 30: Embedded GUI, Optional PC Page in Setup Mode (15 pin D Analog Only)

Enabling the Optional Input

To enable the Optional Input, check the “Enable Optional Input” box and then click the “Set” button. You should now see the fields below the checkbox become enabled (text darkens). The fields are described below.

Full Scale: In this field you should enter the full scale range of the external signal. For example, if you have a Baratron capacitance manometer with a full scale of 100 Torr, then you would put a value of 100 in this field. To enter this value you must click the “Submit” button.

Optional Input: This field reports back what the optional input device is reading. Please note that this value is dependent upon the value in the Full Scale field. To refresh this value, you must refresh the browser. If you desire to watch a continuous data stream of the optional input, then you’ll need to go to the plot page. See the *Optional Input and the Plot Page* section on page 71 for more detail about this.

Optional Input Kp, Optional Input Ki, Optional Input Kd: These values are the PID parameters for Optional Input control. Typically these will be set to match the standard Kp, Ki and Kd values that are factory set before shipment. For information on how to tune your MFC for optimal performance please see *Tuning the MFC for Optional PC* in the following section. This section discusses tuning the standard PID values, but the same rules apply to the optional input parameters. To set any of these parameters you must click the “Submit” button. You can also set these parameters on the Plot Page. To learn more, please see the *Optional Input and the Plot Page* section on page 71.



Note A MFC is typically used as a PI controller only. If the derivative term (K_d) is going to be used, it is recommended that you increase the value in increments of 0.001.

Changing the Optional Input Full Scale Voltage

In the Optional Input Full Scale Voltage section of the page you have the ability to tell the π MFC whether or not the Optional Input signal has a full scale voltage of 10 Volts (*default*) or 5 Volts. To change the voltage click the correct option box and then click the “Submit” button located directly above this section.

TCP/IP Info

On this page you are only allowed to view the current TCP/IP info for the MFC. If you wish to change any of this information please see the *Configuration Page* section on page 62.

Optional PC and the Plot Page

Once you enable the Optional Input the Plot Page will include it in the variable list. A screen capture of the Plot Page with the Optional Input enabled is shown below. You can see the “Optional Input” variable listed in the variable list.

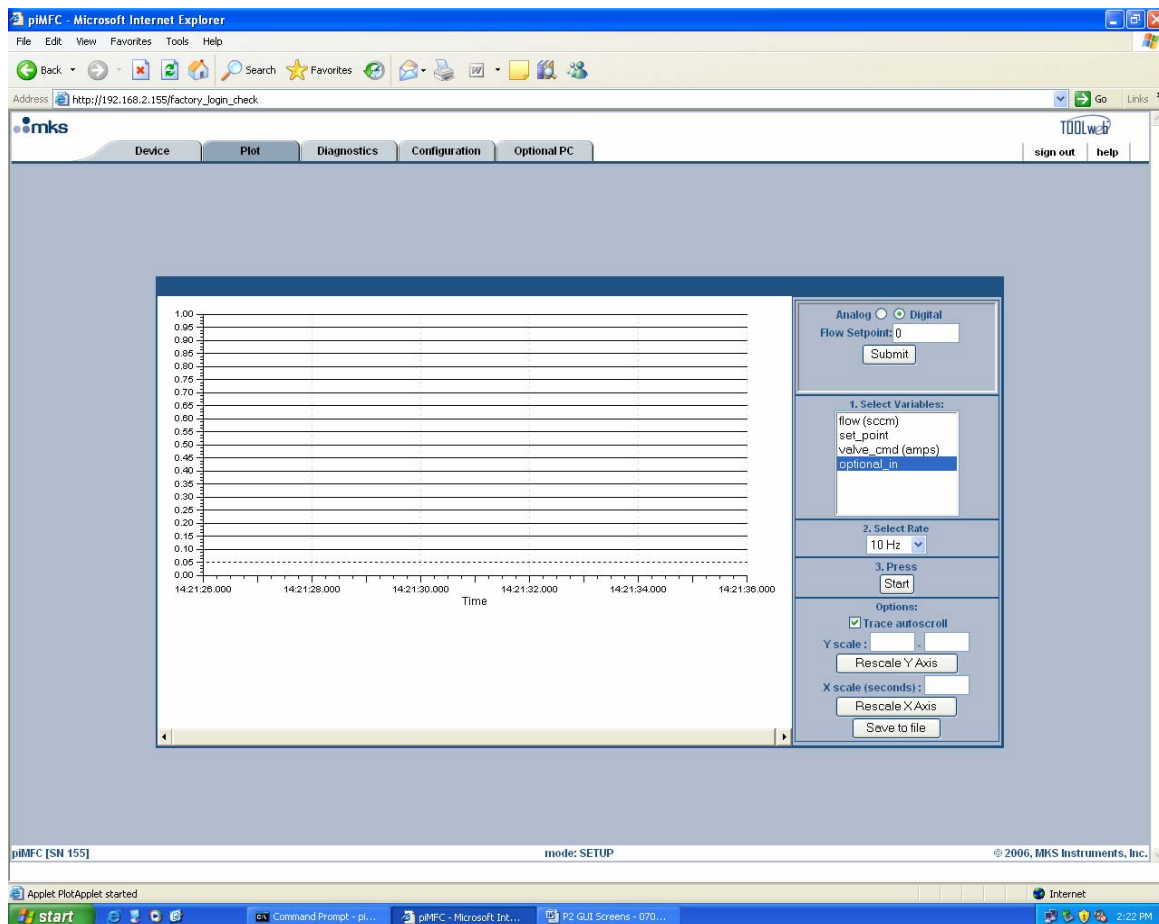

Figure 31: Embedded GUI, Plot Page with Enabled Optional Input (15 pin D Analog Only)

The Optional PID parameters are always settable on the plot page, but they will have no effect unless the Optional Input is enabled. If not already set, it is recommended that these values be set to the standard K_p , K_i

and Kd values initially. The following section discusses tuning the standard PID values, but the same rules apply to the optional input parameters.



Note A MFC is typically used as a PI controller only. If the derivative term (Kd) is going to be used, it is recommended that you increase the value in increments of 0.001.

Tuning the MFC for Optional PC

Tuning optimizes the way the π PC unit controls your pressure system. As noted in the previous section, *How the MFC Controller Works*, the controller functions as a PID (Proportional-Integral-Derivative) controller, but the recommended use is with the Derivative term off, i.e. set to zero. Thus, in this manual, only the Proportional and the Integral term will be discussed. These values can either be adjusted through the electrical interface, if DeviceNet or RS485, or through the Embedded GUI on the Plot Page in Setup Mode. Each method is discussed in the *Adjusting the Proportional and Integral Control* section on page 73.

Proportional Term

The proportional (P), or gain, term is used as a constant to create a valve drive signal that is proportional to the error signal. The error signal is multiplied by the proportional control setting (K_p), thus creating a proportional valve drive signal. The higher the proportional control, the greater the change in the valve drive signal. Typically, a higher proportional control setting yields a faster response. However, too high a proportional control setting will cause the pressure to oscillate around the set point. Too low a proportional control setting will result in a slow response from the controller. The following figure shows the effects of the Proportional term.

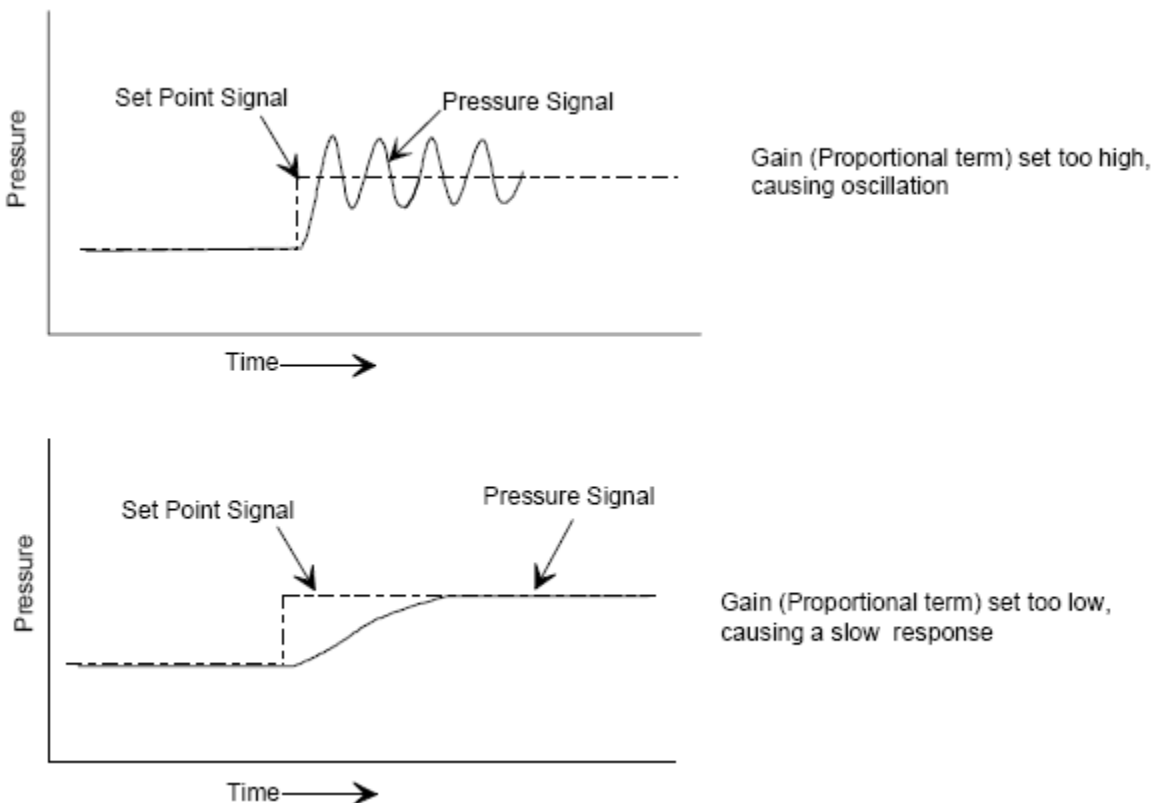

Figure 32: Effects of the Proportional Control

The proportional control setting (K_p) has a minimum value of zero but no maximum value. The factory-shipped setting is for a typical mass flow control system with Nitrogen as the process gas. The actual value depends on the configuration of the MFC. See the *Adjusting the Proportional and Integral Control* section for an explanation of how to set the proportional control setting (K_p) using the different methods.

Integral Term

The action of the Integral (I) term creates a valve drive signal that is proportional to the magnitude and sign of the area under the error signal curve (error signal with respect to time). Therefore, as time passes, the integral term acts to position the valve to reduce the error signal to zero. A decrease in the integral control setting (K_i) increases the period of time over which the error signal is generated, and the system response gets slower. The following figure shows the effects of the Integral term.

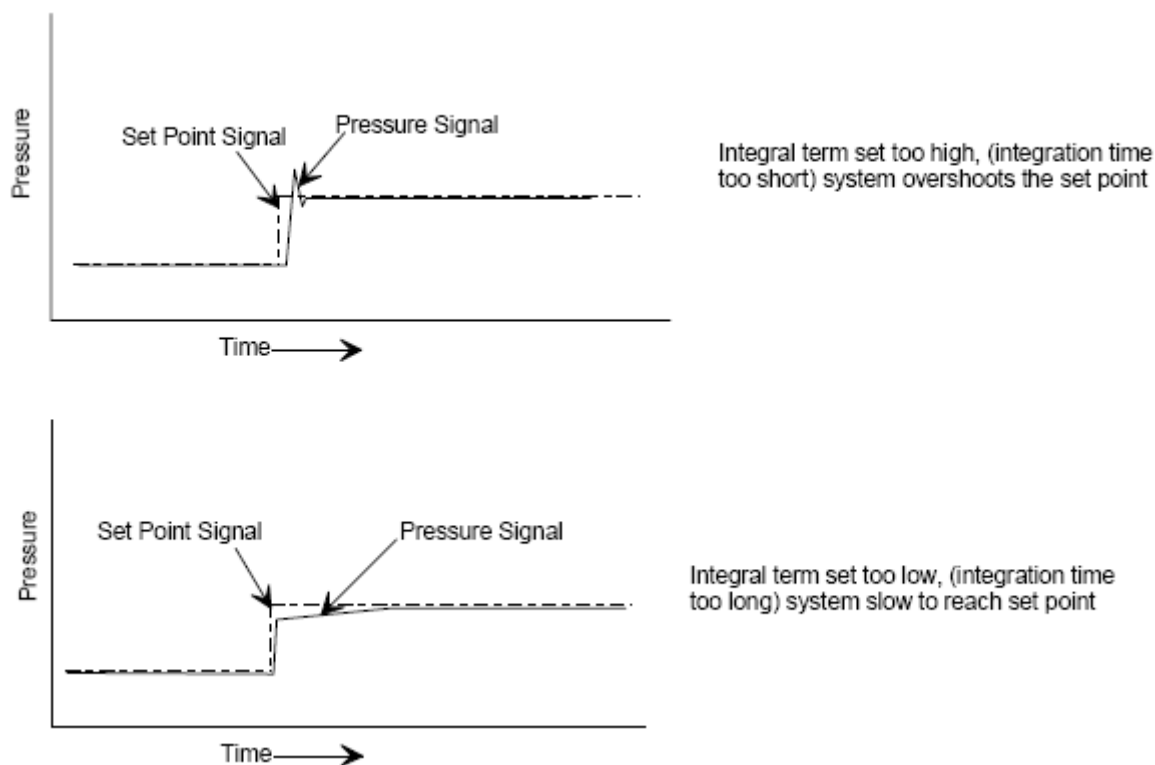

Figure 33: Effects of the Integral Control

The proportional control setting (K_i) has a minimum value of zero but no maximum value. The factory-shipped setting is for a typical mass flow control system with Nitrogen as the process gas. The actual value depends on the configuration of the MFC. See the *Adjusting the Proportional and Integral Control* section on page 73 for an explanation of how to set the integral control setting (K_i) using the different methods.

Adjusting the Proportional and Integral Control

Over Ethernet you have the ability to view the current values for the proportional control setting (K_p) and the integral control setting (K_i) and change them. To do this, follow the steps listed below:

1. Connect to the Embedded GUI, see *Logging On to Your MFC* on page 58.
2. Enter Setup Mode, see *Setup Mode* on page 64.

3. Go to the Plot Page. Here you are able to adjust the settings. See the Setup Mode *Plot Page* section on page 67 for further instructions.

Chapter Seven: Maintenance

General Information

In general, no maintenance is required other than proper installation and operation. Periodically check for wear on the cables and inspect the enclosure for visible signs of damage. If a mass flow device fails to operate properly on receipt, check for shipping damage, and check the device's cable for proper power supply. Any damage should be reported to the freight carrier and MKS Instruments immediately. If there is no obvious damage, and the unit fails to operate properly, obtain an RMA Number (Return Materials Authorization Number) before returning the unit to MKS Instruments for service to expedite handling and ensure proper servicing of your instrument.

Recalibration

It is recommended that the instrument be recalibrated annually (once per year) if no other time interval has been specifically established. Refer to the inside of the back cover of this instruction manual for a complete list of MKS Calibration and Service Centers.

Flow Zero Adjustment

Recommended Interval

For the best accuracy and repeatability performance of the MFC, the zero output of the device should be periodically checked and reset, if necessary. All MFCs should be zeroed under actual installation conditions prior to use. Very slight offsets in the zero condition can contribute to flow measurement inaccuracy. This may be especially noticeable at the lower end of the device range. At minimum, it is recommended that the MFC be checked and zeroed, if necessary:

- At the time of initial installation (or reinstallation).
- Any time the ambient temperature at the MFC changes more than 10 degrees Centigrade.
- Monthly, as part of a normal preventative maintenance procedure.

Methods to Adjust the MFC Flow Zero

There are multiple methods to adjust the Flow Zero of the P3B and P4B MFCs. The methods available depend on the I/O type, either analog or digital.

Analog I/O Devices

- Manually - Depress and hold the zero ("Select") button on the top of the device enclosure for three (3) seconds.
- Via the Ethernet UI – Connect to the device using the Ethernet UI and enter the Setup Mode. Go to the Configure Tab and zero using the "Zero Flow" button on the screen. See Figure 27.
- Electronically (15 Pin D analog only) – Pull Pin 9 to ground for three (3) seconds.

Digital I/O Devices

- Manually - Depress and hold the zero (“Select”) button on the top of the device enclosure for three (3) seconds.
- Via the Ethernet UI – Connect to the device using the Ethernet UI and enter the Setup Mode. Go to the Configure Tab and zero using the “Zero Flow” button on the screen. See Figure 27.
- Via the protocol Zero Service.
 - For DeviceNet – Refer to “MKS P4 Devicenet Profile Document”.
 - For RS485 – Refer to “MKS Document, Command Specification, P4 RS485 Interface”.

Flow Zero Adjustment Procedure

Assure that the MFC is setup in the exact process conditions:

- a) Verify that the MFC is installed in the final equipment and orientation (base up, base down, vertical flow up, etc.)
- b) Verify that the MFC is powered at operating temperature for at least 30 minutes.

If the MFC will be subjected to elevated ambient temperature conditions, verify that these temperatures have been achieved and stable for at least 30 minutes before continuing.

- 2) Verify that the pressure drop across the MFC is reduced to zero. Depending on the gas panel configuration, this may be done by one of the following procedures.

- a) **System has upstream and downstream positive shut off valves**

Close the upstream valve.

- i) Close the downstream valve.

Open the MFC’s control valve.

- ii) Allow pressure across MFC to equilibrate as flow output approaches zero and stabilizes.

Close the MFC’s control valve.

- iii) Wait one minute and adjust the zero using one of the methods specified for the device I/O type.

- b) **For systems with downstream valve only** - Zero the MFC at typical operating inlet pressure.

- i) Close the downstream valve.

- ii) Open the MFC’s control valve.

- iii) Allow pressure to equilibrate across the MFC as flow output approaches zero and stabilizes.

- iv) Close the MFC’s control valve.

- v) Wait one minute and adjust zero using one of the methods specified for the device I/O type.

- c) **For systems with upstream valve only** - MFC may be re-zeroed with downstream line under vacuum or atmosphere.

- i) Close the upstream valve.

- ii) Open the MFC’s control valve.

- iii) The MFC may be evacuated to vacuum or exposed to atmosphere on downstream side. For either case, the downstream pressure must be kept constant to insure there is no pressure drop across MFC.

- iv) Allow pressure to equilibrate across MFC as flow output approaches zero and stabilizes.

- v) Close the MFC’s control valve.

- vi) Wait one minute and adjust zero using one of the methods specified for the device I/O type.

DeviceNet Zeroing Commands

The MFC must be in the executing state then send the zero service with a target value of zero. The following assumes explicit messaging only using the DeviceNet communication protocol.

Place the device in the Executing State through the S-Device Supervisor Object: Note the response Status: Success

The following DeviceNet Command places the device in executing.

Service 0x06, Class 0x30, Instance 1

1. Verify you are in executing through the S-Device Supervisor Object: Note the response Data (hex): 04 means we are in executing. Attribute 0x0B The following DeviceNet Command is used to verify you are in executing.

Service 0xE, Class 0x30, Instance 1, Service Data (attribute) 0x0B

You should get response data of 0x04

3. Send the Zero Adjust Service using S-Analog Sensor Object Instance 1 (Flow)

The following DeviceNet Command Starts the Pressure zero.

Service 0x4B, Class 0x31, Instance 1, Service Data (Target Value) can be Empty Data or Data Type based value, i.e. 2 byte for integer or 4 byte real value, if a value is used, it must be a target value equal to zero.

4. The Flow zeroing procedure usually takes several seconds to perform. Recheck your flow to verify zero has occurred. You can also perform an explicit GET(Service 0x0E) on Class 0x31, Instance 1, Attribute 0x1C, which is the Autozero Status. This attribute's service data will equal "1" while zeroing is in progress and equal "0" when the zeroing has completed. It is most important that the device is at a zero flow, if a high flow is detected by the MFC, then zeroing will not occur.

This page intentionally left blank.

Chapter Eight: Troubleshooting

Troubleshooting Chart

Table 14: Troubleshooting Chart

<u>Symptom</u>	<u>Possible Cause</u>	<u>Check/Corrective Action</u>
MFC display does not light (P4B)	No power	Check power source
	Low power	Measure voltage 11-25 VDC (DNet)
	Wrong cable	Check cable
	Bad cable connection	Check pin(s) continuity
MFC does not respond to any setpoint	Bad DNet connection	Verify correct DNet I/O instance
	Control circuit failure	Provide setpoint, gas & pressure to device, run diagnostic using Ethernet interface.
	Low or no power	Check power source, measure voltage
	Contamination/Clogged - blocked MFC device or gas line	Check inlet pressure @ MFC. Check outlet pressure MFC using pressure gauge. Check outlet pressure downstream of positive shut off (pneumatic) valve downstream of MFC. Check air line to pneumatic valve. Check for any restriction such as filter or check valve downstream of MFC.
MFC shows 0 flow when given setpoint	Closed upstream and/or downstream pneumatic valves	Open valves, check inlet pressure
	No gas supply	Turn on gas supply
	Upstream clogged filter/component	Check flow through of components by measuring pressure drop across device
	MFC clogged orifice	Verify MFC inlet pressure, check valve current for open valve condition. Check for gas flow downstream of MFC - If flow does not exist, possible clogged orifice

	MFC clogged sensor	Run MFC diagnostics. Verify MFC inlet pressure, check valve current for open valve condition and check for gas flow downstream of MFC. If flow present, possible clogged sensor
	MFC control circuit failure	Run MFC diagnostics. If error results, contact MKS service center.
MFC shows output flow > FS (overrange)	MFC valve full open	Check valve current for maximum condition
	Pressure drop across MFC is greater than specification	Measure upstream pressure & downstream pressure. Compare to specification.
	Faulty valve control circuit/calibration	Run MFC diagnostics using Ethernet GUI
	Possible contamination in valve assembly	Cycle-purge MFC to clear suspected contamination
MFC output signal does not match setpoint	Contamination	Check for partial block orifice or sensor. Cycle purge MFC to clear contaminant
	Inlet pressure too low	Increase inlet pressure
	Outlet pressure too high	Decrease outlet pressure
	Flow signal is not properly grounded.	Check for ground loops.
	Control electronics failure, sensor failure	Run MFC diagnostics test
MFC output signal oscillates	Inlet pressure oscillates	Check for faulty regulator
	Inlet pressure too high	Lower inlet pressure
	Inlet pressure too high	Adjust programmed inlet pressure through Ethernet GUI.
	MFC nameplate gas not same as actual gas	Check for programmed gas using Ethernet GUI or digital interface. Reprogram as necessary
	Faulty control circuit	Run MFC diagnostic test.

MFC output signal matches setpoint, but actual gas flow less (as determined by transfer standard)	Contaminated bypass	Check process chamber pressure. Compare to normal or reference.
	MFC programmed for different gas	Compare gas programmed in MFC to actual gas used. Verify using DNet or Ethernet interface.
MFC cannot achieve FS flow	Inlet pressure low	Increase inlet pressure
	Outlet pressure high	Decrease outlet pressure
	Valve contamination	Check valve current for maximum position
	Gas line blockage/contamination	Measure pressure drop across component suspected of contamination such as filter or check valve
	MFC setpoint in counts > than 100% FS of 24567 counts	Program attributed 6 to 100% = 24567 counts (0x6000)
Output signal matches setpoint @ higher flows, but will not go to 0	MFC valve partial contamination	Cycle-purge device, check valve current
	Faulty control valve, adjustment or electronics	Run MFC diagnostics, call MKS service center
	Inlet pressure too high	Decrease inlet pressure
	Device zero offset	re-zero device with known zero flow conditions
Display powers up, but MFC does not respond	Bad DNet/RS485 connection	Check status DNet polled connection/RS485 connection. check network LED
	Incorrect MAC ID Address	Check MAC ID on device
	Incorrect baud rate setting	Check baud rate on device
	Incorrect DNet I/O Instance Setting	Check I/O setting using DNet commissioning tool/software
		Check tool host
	Low power, power supply	Measure current & voltage from power source
MFC output shows large overshoot	Inlet pressure too high	Decrease inlet pressure
	Actual inlet pressure higher than pressure programmed to	Adjust programmed inlet pressure through Ethernet GUI.

MFC output slow to respond to setpoint	device.	
	MFC not programmed for correct gas - actual gas used different	Check MFC active gas using digital interface or Ethernet GUI
	MFC control parameters set incorrectly	Contact MKS service center
	Inlet pressure too low	Increase inlet pressure
	Actual inlet pressure lower than pressure programmed to device.	Adjust programmed inlet pressure through Ethernet GUI.
	MFC not programmed for correct gas - actual gas used different	Check MFC active gas using digital interface or Ethernet GUI
	MFC control parameters set incorrectly	Contact MKS service center
Output signal > zero with confirmed zero flow condition	MFC device zero offset	Re-zero device per instruction manual
	Fault in valve adjustment, gap between plug & orifice	Contact MKS service center
Pressure output signal different than confirmed line pressure	Zero offset in pressure transducer	Re-zero pressure transducer using known pressure standard & Ethernet GUI

DeviceNet LED indicator (color)	State	Indication
- Network status LED		
Green	Link OK, On-line, Connected	The device in on-line and has connection in the established state.
		- For a Group 2 only device it means that this device is not allocated to a master.

Flashing Green	On-line, Not Connected	Device is on-line but has no connection in the established state.
		- The device has passed The Dup_MAC_ID test, is on-line, but has no established connections to other nodes. - For a Group 2 only device it means that this device is not allocated to a master.
Red	Critical Link Failure	Failed communication device. The device has detected an error that has rendered it incapable of communicating on the network (Duplicate MAC ID, or Bus-off)
Flashing Red	Connection Time-Out	One or more I/O Connections are in the Timed-Out state.
Flashing Red & Green	Communication Faulted and Received an Identify Comm Fault Request - Long Protocol	A specific Communication Faulted device. The device has detected a Network Access error and is in the Communication Faulted state. The device has subsequently received and accepted an Identify Communication Faulted Request - Long Protocol message.
Off	Not Powered/Not On-Line	Device is not on-line
		- The device has not completed The Dup_MAC-ID test yet - The device may not be powered, look at Module Status LED.
- DeviceNet Module Status Indicator		
Green	Device operational	The device is operating in a normal condition
Flashing Green	Device in Standby (The Device Needs Commissioning)	The device needs commissioning due to configuration missing, incomplete or incorrect.
Red	Unrecoverable Fault	The device has an unrecoverable fault; may need replacing.
Flashing Red	Minor Fault	Recoverable Fault

Flashing Red & Green	Device Self Testing	The Device is in Self Test. Reference the Identity Object in Volume II for Device states.
Off	No power	There is no power applied to the device

This page intentionally left blank.

Appendix A: Product Specifications

Performance Specifications –P4B/P3B

Full Scale Flow (N2 equivalent)	10-50000 sccm
Maximum Inlet Pressure	150 psig, limited to maximum differential pressure across MFC.
Normal Operating Pressure Differential (with atmospheric pressure at the MFC outlet)	10 to 5000 sccm, 10 to 40 psid 10000 to 20000 sccm 15 to 40 psid 30000 to 50000 sccm 25 to 40 psid
Proof Pressure	1000 psig
Burst Pressure	1500 psig
Control Range	2% to 100% of F.S.
Accuracy	± 1% of setpoint for > 20 to 100% F.S. ± 0.2% of FS for 2 to 20% F.S.
Repeatability	± 0.3% of Reading
Resolution	0.1% of Full Scale
Temperature Coefficients Zero Span	<0.05% F.S./°C <0.08% Reading/°C
Inlet Pressure Coefficient	< 0.02% of Reading./psi
Typical Controller Settling Time (per SEMI Guideline E17-0600)	~ 500 milliseconds typical above 5% F.S.
Warm-Up Time (to within 0.2% of F.S. of steady state performance)	< 30 min.
Normal Operating Temperature Range	10°C to 50°C
Storage Humidity	0 to 95% Relative Humidity, non-condensing
Storage Temperature	-20°C to 65°C (-4°F to 149°F)
Temperature Display Range	0 to 100°C
Temperature Readout Units	°C
Temperature Accuracy	± 2°C
Temperature Resolution	0.1°C
ROHS Compliant	Yes

Specifications are subject to change without notice.

Mechanical Specifications

Fittings (compatible with)	Swagelok, 4 VCR, 1-1/8" surface mount (C-seal, W-seal)
Display	4 digits for value, 4 characters for unit
Leak Integrity External (scc/sec He) Through closed valve	< 1 x 10 ⁻¹⁰ < 1.0% for F.S. at 25 psig inlet to atmosphere
Wetted Materials Standard	316L S.S. VAR (equivalent to 316 S.S. SCQ for semiconductor quality), 316 S.S. , Inconel, KM-45, PTFE
Surface Finish	10 μinches, average Ra
Weight	≤ 2 lbs (0.9 kg)

Electrical Specifications

<u>Analog I/O</u> Input Voltage Required Max current at start-up (first 5 sec.) Typical current at steady state	+11 to +25 VDC 15VDC (±5 %) @ 350 mA 15VDC (±5 %) @ 280 mA
Set Point Command Signal	0 to 5 VDC
Flow Output Signal	0 to 5 VDC (into high impedance load, minimum 10K-ohm)
Output Impedance	< 1 Ω
Connectors	15-pin Type "D", 9-pin Type "D"
<u>Digital I/O (DeviceNet)</u> Data Rate/Network Length	Date Rate (User selectable) 125 Kbps, 500 m (1,640 ft) 250 Kbps, 250m (820 ft) 500 Kbps, 100m (328 ft)
Level of Filtering	User software adjustable
Digital Functions (flow)	Select units: counts, slm, sccm % of F.S. Remote Zero Set/read flow rate Flow totalizer and run hours Valve soft start Monitor MFC status – valve drive level and trip points (alarm for high flow, alarm for low flow, warning for high flow, warning for low flow) Reset factory defaults Report run time hours Change user tags and device address

	Device Identification Storage includes manufacturer information, model and serial number, original factory calibration, software and hardware revision numbers.
Digital Functions (temperature)	Set units Read temperature Alarm enable, Warning enable Alarm settling time, Warning settling time Alarm trip point high, Warning trip point high Alarm trip point low, Warning trip point low Zero adjust
Data Rate Switch	4 positions: 125, 250, 500K, PGM (programmable over the network)
MAC ID Switches	2 switches, 10 positions; 0,0 to 6,3 are hardware ID numbers: 7,0 to 9,9 are software ID numbers; (6,4 to 6,9 are unused and, if selected will default to hardware ID number 6,3)
Input Power	11 to 25 VDC per DeviceNet specifications (@ <3.5 watts)
Network Size	Up to 64 nodes
Network Topology	Linear (trunkline/dropline) power and signal on same network cable
Visual Communication Indicators	LED network status (green/red) LED module status (green/red) Scrolling LED displays(Flow Gas , temperature, IP address, Full scale)
<u>Digital I/O (RS485)</u> Date Rate/Network Length	Date Rate (User selectable) 9.6 KBaud 19.2 KBaud 38.4 KBaud
Digital Functions (flow)	Query for MAC – Host controller will use this message to query the existence of a MFC controller. Freeze Follow – Host controller will use this message to configure a MFC controller to act upon a new set point when received. Set Point – Host controller will use this message to send a new set point to a MFC controller. Filtered Set Point – Host controller will use this message to get the current set point from a MFC controller. Indicated Flow - Host controller will use this message to get the current flow reading from a MFC controller. Valve Drive Current - Host controller will use this message to get the valve drive current. Calibration Instance (Process Gas) Selection - Host controller will use this message to select which calibration instance is to be used for flow metering. Query for Calibration Instance (Process Gas) Selected - Host controller will use this message to query the selected calibration instance, which is currently being used for flow metering. Requested Zero Enable - Host controller will use this message to enable requested function.

	<p>Query for Requested Zero Status – Host controller will use this message to query if the requested zero function has been completed.</p> <p>Query for Zero Offset - Host controller will use this message to query the present sensor zero offset.</p> <p>Set Ramp Time – Used to set the ramp time in ms. The set point will ramp in from the present to the new setpoint in this period of time..</p> <p>Query All - This is used to obtain 3 measurements, Flow, valve and temperature in 1 command.</p> <p>Set Actuator Mode - This is used to set valve to open, closed or normal control</p>
Data Rate Switch	3 positions: 9.6, 19.2, 38.4 KBAud (programmable over the network)
MAC ID Switches	2 switches, 10 positions each; 15 available MACIDs (33-47)
Input Power	11 to 25 VDC per DeviceNet specifications (@ <3.5 watts)
Network Size	Up to 256 nodes (15 available MFC MACIDs)
Network Topology	Master/slave
Visual Communication Indicators	LED status (green/red) Scrolling LED displays (Flow Gas , temperature, IP address, Full scale)
Electromagnetic Compatibility	CE Compliant 2004/108/EC

Specifications are subject to change without notice.

Appendix B : Model Code Explanation

Model Code Description

The model code of the MFC defines features of the unit such as device type, flow range, fittings, valve configuration, connector type, seal material and firmware revision.

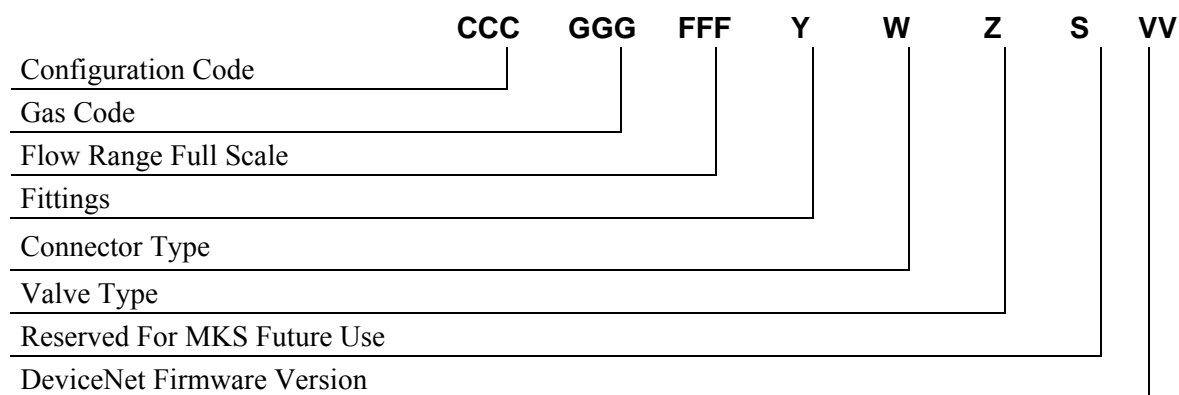

Configuration Code (CCC)

Type P3B MFC Mass Flow Controller(multigas, multi-range – compact length) CCC=P3B.

Type P4B Mass Flow Controller(multigas, multi-range – standard length) CCC=P4B.

Gas Code (GGG)

Gas	Code	Symbol
Acetone	184	C3H6O
Acetylene	042	C2H2
Air	008	Air
Allene	066	C3H4
Ammonia	029	NH3
Argon	004	Ar
Arsine	035	AsH3
Boron Trichloride	070	BCl3
Boron Trifluoride	048	BF3
Bromine	021	Br2
Bromine Pentafluoride	116	BrF5
Bromine Trifluoride	076	BrF3
Bromotrifluoromethane (R-13b1)	080	CBrF3
Butane	117	C4H10

Carbon Dioxide	025	CO2
Carbon Disulfide	040	CS2
Carbon Monoxide	009	CO
Carbon Tetrachloride	101	CCl4
Carbon Tetrafluoride (R-14)	063	CF4
Carbonyl Sulfide	034	COS
Chlorine	019	Cl2
Chlorine Trifluoride	077	ClF3
Chlorodifluoromethane (R-22)	057	CHClF2
Chloroform (Trichloromethane)	071	CHCl3
Chloropentafluoroethane (R-115)	119	C2ClF5
Chlorotrifluoromethane (R-13)	074	CClF3
Cyanogen	059	C2N2
Cyanogen Chloride	037	ClCN
Cyclopropane	061	C3H6
Deuterium	014	D2
Diborane	058	B2H6
Dichlorodifluoromethane (R-12)	084	CCl2F2
Dichlorofluoromethane (R-21)	065	CHCl2F
Dichlorosilane	067	SiH2Cl2
1,2-Dichlorotetrafluoroethane (R-114)	125	C2Cl2F4
Difluoroethylene (R-1132a)	064	C2H2F2
Difluoromethane	160	CH2F2
Dimethylamine	085	C2H7N
Dimethylpropane	122	C5H12
Disilane	097	Si2H6
Ethane	054	C2H6
Ethanol	136	C2H6O
Ethyl Acetylene	093	C4H6
Ethyl Chloride	075	C2H5Cl
Ethylene	038	C2H4
Ethylene Oxide	045	C2H4O
Fluorine	018	F2
Germane	043	GeH4
Germanium Tetrachloride	113	GeCl4
Helium	001	He
Hexafluoro Butadiene-1,3	297	C4F6
Hexafluoroethane (R-116)	118	C2F6
Hexafluoropropylene	138	C3F6
Hexane	127	C6H14
Hydrogen	007	H2
Hydrogen Bromide	010	HBr
Hydrogen Chloride	011	HCl

Hydrogen Cyanide	024	HCN
Hydrogen Fluoride	012	HF
Hydrogen Iodide	017	HI
Hydrogen Selenide	023	H ₂ Se
Hydrogen Sulfide	022	H ₂ S
Iodine Pentafluoride	115	IF ₅
Isobutane	111	C ₄ H ₁₀
Isobutylene	106	C ₄ H ₈
Krypton	005	Kr
Methane	028	CH ₄
Methanol	176	CH ₄ O
Methyl Acetylene	068	C ₃ H ₄
Methyl Bromide	044	CH ₃ Br
Methyl Chloride	036	CH ₃ Cl
Methyl Fluoride	033	CH ₃ F
Methyl Mercaptan	047	CH ₄ S
Methylamine	052	CH ₅ N
Methyltrichlorosilane	183	CH ₃ Cl ₃ Si
Molybdenum Hexafluoride	124	MoF ₆
Neon	002	Ne
Nitric Oxide	016	NO
Nitrogen	013	N ₂
Nitrogen Dioxide	026	NO ₂
Nitrogen Trifluoride	053	NF ₃
Nitrosyl Chloride	141	NOCl
Nitrous Oxide	027	N ₂ O
Octafluorocyclobutane (R-c318)	129	C ₄ F ₈
Oxygen	015	O ₂
Oxygen Difluoride	041	OF ₂
Ozone	030	O ₃
Pentaborane	142	B ₅ H ₉
Pentafluorethane	155	C ₂ HF ₅
Perchloryl Fluoride	072	ClO ₃ F
Perfluoropropane	128	C ₃ F ₈
Phosgene	060	CCl ₂ O
Phosphine	031	PH ₃
Phosphorous Oxychloride	102	POCl ₃
Phosphorous Pentafluoride	143	PF ₅
Propane	089	C ₃ H ₈
Propylene	069	C ₃ H ₆
Radon	003	Rn
Silane	039	SiH ₄
Silicon Tetrachloride	108	SiCl ₄

Silicon Tetrafluoride	088	SiF4
Sulfur Dioxide	032	SO2
Sulfur Hexafluoride	110	SF6
Sulfur Tetrafluoride	086	SF4
Sulfuryl Fluoride	087	SO2F2
Tetrafluoroethane (R-134a)	156	C2H2F4
Titanium Tetrachloride	114	TiCl4
Toluene	181	C7H8
Trans-Butene	098	C4H8
Trichloroethane	112	C2H3Cl3
Trichlorofluoromethane (R-11)	091	CCl3F
Trichlorosilane	147	SiHCl3
Trichlorotrifluoroethane (R-113)	126	C2Cl3F3
Trifluoromethane (Fluoroform R-23)	049	CHF3
Trimethoxyborine	131	C3H9BO3
Trimethylamine	109	C3H9N
Tungsten Hexafluoride	121	WF6
Uranium Hexafluoride	123	UF6
Vinyl Bromide	056	C2H3Br
Vinyl Chloride	055	C2H3Cl
Xenon	006	Xe

Flow Range Full Range (FFF)

The MFC’s mass flow full scale range is indicated by a three digit code.

Mass Flow Rate	P4B Ordering Code(FFF)	P3B Ordering Code(FFF)
10 sccm	101	101
20 sccm	201	
30 sccm		301
50 sccm	501	
100 sccm	102	102
200 sccm	202	
300 sccm		302
500 sccm	502	
1000 sccm	103	103
2000 sccm	203	
3000 sccm		303
5000 sccm	503	
10000 sccm	104	104

Mass Flow Rate	P4B Ordering Code(FFF)	P3B Ordering Code(FFF)
20000 sccm	204	
30000 sccm	304	304
50000 sccm	504	504

FittingType (Y)

The fitting options are designated by a letter code.

Fitting Style	Ordering Code
Swagelok VCR-4 male	R
Downport C-Seal per SEMI 2787.1	C
Downport W-Seal per SEMI 2787.3F	H

Note: For P3B the only selection available is VCR, “R”.

Connector – Control I/O (W)

The MFC’s connector is designated by a single number code. The MFC is also available with a DeviceNet connector.

Connector Type	Ordering Code
DeviceNet	6
Digital RS485	5
9 Pin D(Analog I/O)	A
15 Pin D(Analog I/O)	B

Note: For P3B the only selection available is DeviceNet, “6”.

Valve (Z)

The seal material option is designated by a letter code. The MFCs are normally closed valve with the following seal type.

Valve Type	Ordering Code
Normally Closed	T
Normally Open	P

Note: For P3B the only selection available is normally open, “P”.

Reserved For MKS Future Use (S)

Standard = 0

Firmware Version (VV)

The firmware version options are designated by a two digit number code for all I/O types.

Example: The release of firmware version 10 for digital I/O products at the date of this manual.

Seal Material	Ordering Code
DeviceNet and RS485 Only	10
Analog I/O Codes A and B	11

Appendix C: Health and Safety Form



HEALTH AND SAFETY FORM

THIS FORM MUST BE COMPLETED AND RETURNED WITH EQUIPMENT OR SERVICE WILL NOT BE PERFORMED

RETURN MATERIAL AUTHORIZATION NUMBER (RMA#):	
RETURN TO STOCK NUMBER/RTS# (If applicable):	Trade in number (if applicable):

Section 1: (one instrument per form)	MKS Part Number:
	MKS Serial Number:

Section 2: Has this equipment been used? *(Please check appropriate boxes)*

<input type="checkbox"/>	No – Still in MKS packaging
<input type="checkbox"/>	No – Unit unpacked, but never installed in a system.
<input type="checkbox"/>	Yes -- Used only with clean, dry inert gas (For Example: Air, N2, Ar, He).
<input type="checkbox"/>	Yes -- Used with chemicals, non-inert gases, biological or radioactive agents. Identify all materials:
<input type="checkbox"/>	Yes -- Used in a Semiconductor Copper process. Equipment must be double bagged. Label outside bag and packing slip, Copper Part. Label final shipping container Copper Part and place a strip of ORANGE TAPE on the container.
	Has equipment been purged? <input type="checkbox"/> No <input type="checkbox"/> yes purged with what?
	Has equipment been flushed? <input type="checkbox"/> No <input type="checkbox"/> yes flushed with what?
	Has equipment been decontaminated? <input type="checkbox"/> no <input type="checkbox"/> yes, explain process:
	How many months in use?

Section 3: Detailed failure information or description or required service or reason for return.

Section 4: Company or Organization (mandatory information)

Company:		
Address:		
City:	State:	Zip:
Printed Name:	Signature:	
Date:	Phone #:	
Email:	Fax #:	
End User (if applicable):		

For MKS USE only:

MKS Subsidiary or Agent:
Contact Name:
Customer #:
Maximum Credit allowed (TBD after inspection)

ALL PRODUCTS MUST BE RETURNED IN SEALED BAGS

MKS will not accept delivery of equipment that has been chemically, radioactively or biologically contaminated, without written evidence of decontamination or laboratory analysis. Alternately, we will require evidence that the biological process is not harmful.

